

# MANIACCESS

## 180 ATJ

- Working height : 17.65 m
- Max. outreach : 10.60 m
- S.W.L : 230 kg
- Diesel engine 45 HP
- Turret rotation : 350°
- 4 simultaneous movements
- 4 wheel drive
- 4 wheel steer
- Crab steer







## 180 ATJ

 **S.W.L.** .....230 kg including 2 people  
**External use :** .....wind 45 km/h

 **Working height** .....17.65 m  
**Platform floor height** .....15.65 m

 **Max. outreach** .....10.60 m  
**Up and over clearance** .....7.15 m  
**Overall length** .....7.77 m  
**Length (transport position)** .....5.77 m  
**Overall width** .....2.30 m  
**Overall height** .....2.37 m  
**Basket size** .....1.80 m x 0.80 m  
**Ground clearance** .....42.5 cm  
**Turning radius ins/outside** .....1.32/3.66 m

 **Turret rotation** .....350°  
**Basket rotation** .....180°  
**Jib movement** .....140°

 **Engine (Low emission)**  
PERKINS 404C22 .....45 HP

 **Maxi. travel speed** .....6 km/h  
**Lifting time** .....40 s

 **Gradeability on rough terrain** .....40 %  
**Max. slope accepted** .....5° or 9%

 **Hydraulic tank** .....54 l.  
**Diesel tank** .....52 l.

 **Tyres** .....12.5 - 18  
4 wheel drive/4 wheel steer/crab steer

 **Weight** .....8090 kg

### Standard equipment

- Proportional controls
- 4 simultaneous movements
- Foam filled tyres
- Differential lock
- Limited front axle slip
- Diagnostic tools
- Hour meter
- Klaxon
- Rotating beacon
- Slope and overload alarm in the basket
- Overslope unlocking
- Lifting brackets
- Safety electric pump
- 230 V auxiliary power cable

### Options

- **Oscillating axle**
- **Continuous rotation**
- **On board generator set**
- Electric plug in platform (230V)

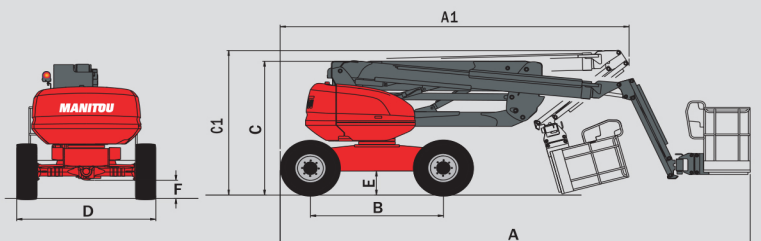
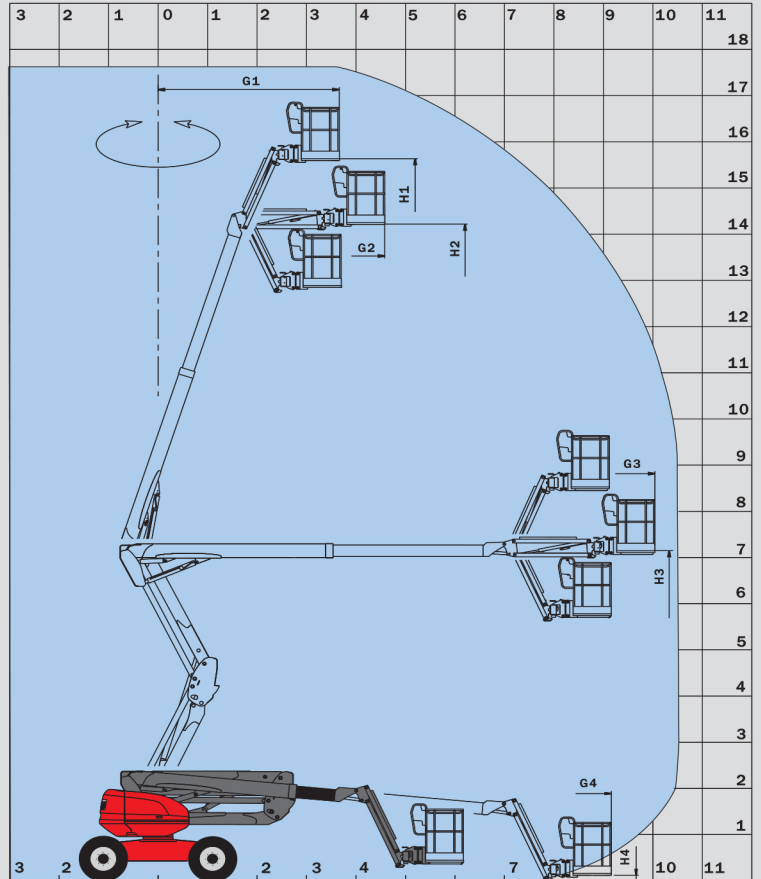

A	7775
A1	5770
B	2200
C	2370
C1	2560
D	2300
E	425
F	325
G	1325
G1	3660
G2	4580
G3	10040
G4	9160
H	3665
H1	15700
H2	14250
H3	7150
H4	120
I	4530
J	6875
K	2730

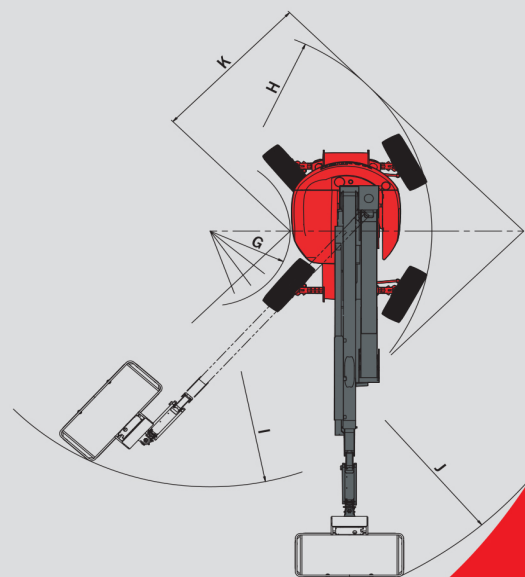

This publication in no way constitutes an offer and the company reserves the right to alter specification without prior notice.  
The MANITOU models presented in this brochure can be supplied complete with optional equipment attachments.



**MANITOU BF SA**

B.P. 249 - 44158 Ancenis Cedex - France  
Tél. : 33 2 40 09 10 11 / Export Department Fax : 33 2 40 09 10 97  
www.manitou.com

700183EN

