



**Bobcat®**  
**Bobcat®**

EN

---

# Operation & Maintenance Manual

## E10 Compact Excavator

---

S/N A33P11001 & Above

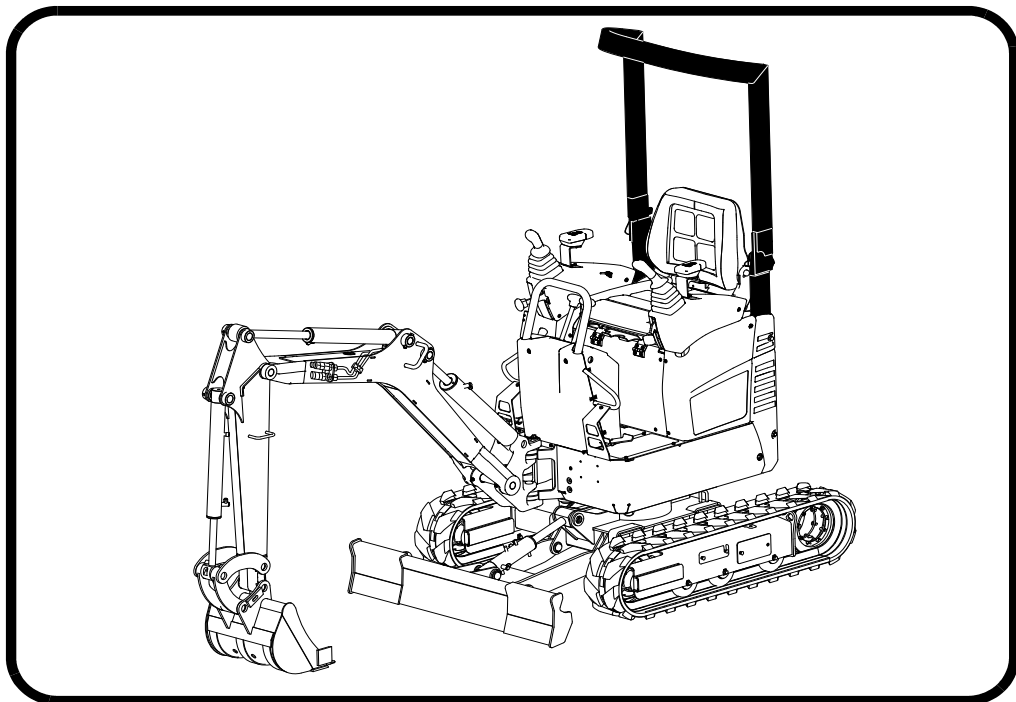

# OPERATOR SAFETY WARNING



## WARNING

Operator must have instructions before operating the machine. Untrained operators can cause injury or death.

W-2001-0502



**Safety Alert Symbol:** This symbol with a warning statement, means: "Warning, be alert! Your safety is involved!" Carefully read the message that follows.

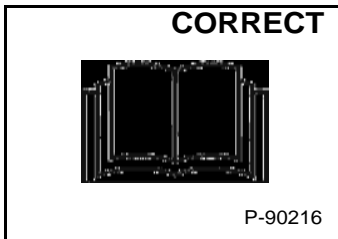

- ⚠ Never operate without instructions.
- ⚠ Read machine signs, Operation & Maintenance Manual, and Operator's Handbook.

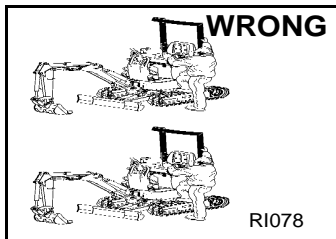

- ⚠ Do not grasp control handles when entering machine.
- ⚠ Be sure controls are in neutral before starting.
- ⚠ Sound horn and check behind machine before starting.

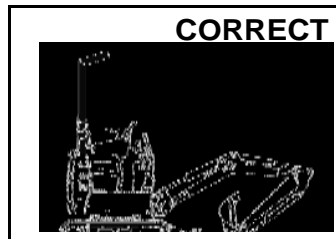

- ⚠ Never operate without approved TOPS.
- ⚠ Never modify equipment.
- ⚠ Never use attachments not approved by Bobcat Company.

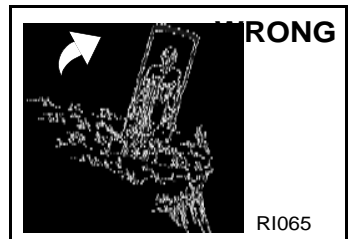

- ⚠ Avoid steep areas or banks that could break away.

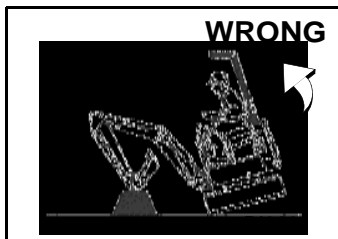

- ⚠ Use caution to avoid tipping - do not swing heavy load over side of track.
- ⚠ Operate on flat, level ground.

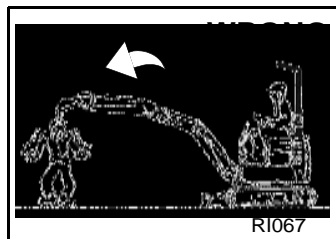

- ⚠ Keep bystanders out of maximum reach area.
- ⚠ Do not travel or turn with bucket extended.
- ⚠ Never carry riders.

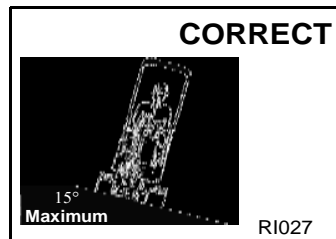

- ⚠ Never exceed a 15° slope to the side.

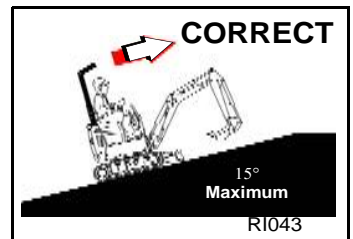

- ⚠ Never travel up a slope that exceeds 15°.

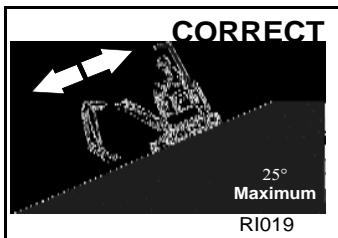

- ⚠ Never exceed 25° when going down or backing up a slope.

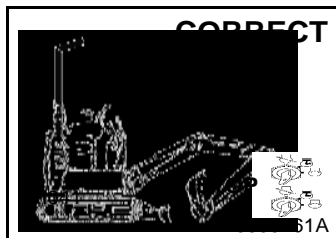

- ⚠ To leave excavator, lower the attachment.
- ⚠ Stop the engine.

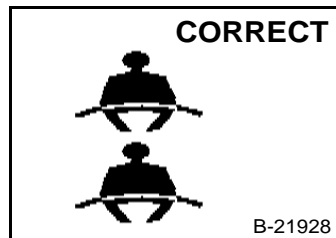

- ⚠ Use TOPS and fasten seat belt securely.
- ⚠ Operate controls only from operator's seat.
- ⚠ Keep feet and hands on controls.

### SAFETY EQUIPMENT

1. Seat Belt
2. Slew Lock
3. TOPS
4. Safety Signs (Decals)
5. Safety Tread
6. Grab Handles
7. Operator's Handbook: Must be on machine.

OSW56-0409



**Bobcat®**



## CONTENTS

CONTENTS .....	4
FOREWORD .....	6
SAFETY & TRAINING RESOURCES .....	18
OPERATING INSTRUCTIONS .....	30
PREVENTIVE MAINTENANCE .....	60
SPECIFICATIONS .....	94
WARRANTY .....	104
ALPHABETICAL INDEX .....	108

### REFERENCE INFORMATION

Write the correct information for YOUR Bobcat excavator in the spaces below. Always use these numbers when referring to your Bobcat excavator.

Excavator Serial  
Number

Engine Serial Number

---

---

NOTES:

---

---

---

---

YOUR BOBCAT DEALER:

ADDRESS:

PHONE:

Bobcat Company Europe  
Drève Richelle 167  
B-1410 WATERLOO  
Belgium





**Bobcat®**



## FOREWORD

This Operation & Maintenance Manual was written to give the owner / operator instructions on the safe operation & maintenance of the Bobcat excavator. READ AND UNDERSTAND THIS OPERATION & MAINTENANCE MANUAL BEFORE OPERATING YOUR BOBCAT EXCAVATOR. If you have any questions, see your Bobcat dealer. This manual can illustrate options and accessories not installed on your excavator.

DECLARATION OF CONFORMITY .....	8
BOBCAT COMPANY IS ISO 9001 CERTIFIED.....	10
REGULAR MAINTENANCE ITEMS.....	10
LUBRICANTS AND FLUIDS.....	11
SERIAL NUMBER LOCATIONS.....	12
Excavator Serial Number .....	12
Engine Serial Number .....	12
DELIVERY REPORT .....	13
BOBCAT EXCAVATOR IDENTIFICATION .....	14
FEATURES, ACCESSORIES, AND ATTACHMENTS.....	15
Standard Features.....	15
Options And Accessories .....	15
Attachments .....	15
OPERATOR CANOPY (TOPS).....	16



**Bobcat®**



**DECLARATION OF CONFORMITY**

<b>Contents of EC Declaration of Conformity</b> This information is provided in the operators manual to comply with clause 1.7.4.2(c) of Annex I of Machinery Directive 2006/42/EC. The official EC Declaration of Conformity is supplied in a separate document.	
<b>Manufacturer</b>  Bobcat Company World Headquarters 250 East Beaton Drive West Fargo, ND 58078-6000 UNITED STATES OF AMERICA	<b>Directive 2000/14/EC: Noise Emission in the Environment by Equipment For Use Outdoors</b>  <b>Notified Body</b> Technical and Test Institute for Construction Prague Czech Republic Notified Body Number: 1020  <b>EC Certificate No.</b> 1020-090-022395
<b>Technical Documentation</b> Doosan Benelux SA Drève Richelle 167 B-1410 Waterloo BELGIUM	<b>Conformity Assessment Procedure(s)</b> 2000/14/EC, Annex VIII, Full Quality Assurance  <b>Sound Power Levels [Lw(A)]</b> Measured Sound Power <span style="float: right;"><b>93 dBA</b></span> Guaranteed Sound Power <span style="float: right;"><b>93 dBA</b></span>
<b>Description of Equipment</b> Type of Equipment: Excavator Model Name: E10*AAEM Model Code: A33P  Engine Manufacturer: Kubota Engine Model: D722-E2B-BCZ-6 Engine Power: 7.4 kW @ 2000 RPM	<b>Equipment conforms to CE Directive(s) Listed Below</b> 2006/42/EC: Machinery Directive 2004/108/EC: Electromagnetic Compatibility Directive
<b>Declaration of Conformance</b> This equipment conforms to the requirements specified in all the EC Directives listed in this declaration.	
<b>Effective From:</b>  29 December 2009	





**Bobcat**®



**BOBCAT COMPANY IS ISO 9001 CERTIFIED**









**ISO 9001** is an international standard that specifies requirements for a quality management system that controls the processes and procedures which we use to design, develop, manufacture and distribute Bobcat products.

British Standards Institute (**BSI**) is the Certified Registrar Bobcat Company chose to assess the Company's compliance with the ISO 9001 at Bobcat's manufacturing facilities in Gwinner and Bismarck, North Dakota (U.S.A.), Pontchateau (France), Dobris (Czech Republic) and the Bobcat corporate offices (Gwinner, Bismarck & West Fargo) in North Dakota. Only certified assessors, like BSI, can grant registrations.

ISO 9001 means that as a company we say what we do and do what we say. In other words, we have established procedures and policies, and we provide evidence that the procedures and policies are followed.

**REGULAR MAINTENANCE ITEMS**

 <p>ENGINE OIL FILTER (6 pack) 6671057</p>	 <p>PRIMARY HYDRAULIC FILTER 6653336</p>
 <p>FUEL FILTER 6667352</p>	 <p>BATTERY 6669600</p>
 <p>AIR FILTER, Outer 6673752</p>	 <p>RADIATOR CAP 6702797</p>
 <p>AIR FILTER, Inner 6673753</p>	

**NOTE:** Always verify Part Numbers with your Bobcat dealer.

## LUBRICANTS AND FLUIDS

The lubricants and fuels described below are standard for operating conditions in European temperate climate areas. Please consult your Bobcat dealer for requirements under other weather conditions.

Packaging		ENGINE / LOADER TRANSMISSION				HYDRAULIC/ HYDROSTATIC		ANTIFREEZE COOLANT			AXLE / TRANSMISSION		BRAKE FLUID	
		Bobcat Engine Power SAE 0W/30	Bobcat Engine Power SAE 10W/30	Bobcat Engine Power SAE 15W/40	Bobcat Engine Power SAE 20W/50	Bobcat Superfor SH Hydraulic/Hydrostatic	Bobcat Bio Hydraulic Hydraulic/Hydrostatic	Bobcat PG Coolant Concentrated	Bobcat PG Coolant 4 Seasons	Bobcat EG Coolant Concentrated	Bobcat EG Coolant Premixed	Bobcat Axle / Transmission Oil SAE 85W/90	Bobcat Axle / Transmission Oil ISO 100	Bobcat Brake Fluid LHM
Linear		6987500A	6904840A	6904841A	6987501A	6904842A	6904843A	6987646A	6904844A	6987596A	6987597A	6987602A	6904846A	
5 L Can		6987500B	6904840B	6904841B	6987501B	6904842B	6904843B	6987646B	6904844B	6987596B	6987597B	6987602B		
25 L Container		6987500C	6904840C	6904841C	6987501C	6904842C	6904843C	6987646C	6904844C	6987596C	6987597C	6987602C		
209 L Drum		6987500D	6904840D	6904841D	6987501D	6904842D	6904843D	6987646D	6904844D	6987596D	6987597D	6987602D		
1000 L Tank														
					Bobcat Multi-Purpose Grease					6903122				
					Bobcat Supreme HD Grease					6687884				
					Bobcat Extreme HP Grease					6687885				

4700300-EN (10-09)

**NOTE: Always verify Part Numbers with your Bobcat dealer.**

## SERIAL NUMBER LOCATIONS

Always use the serial number of the excavator when requesting service information or when ordering parts. Early or later models (identification made by serial number) can use different parts, or it can be necessary to use a different procedure in doing a specific service operation.

### Excavator Serial Number

Figure 1

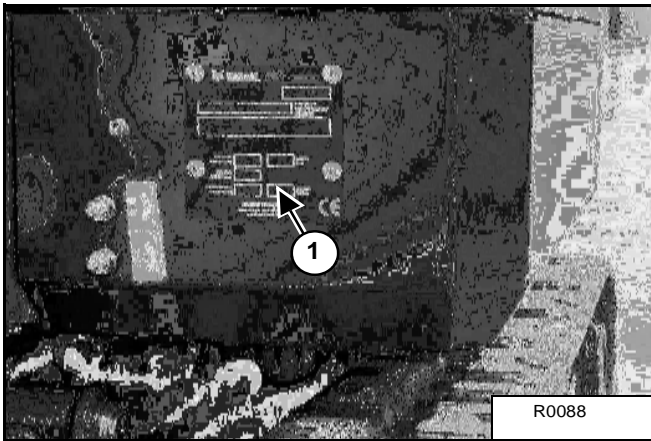

The excavator serial number plate (Item 1) [Figure 1] is located on the front left hand corner of the frame.

Explanation of Excavator Serial Number:

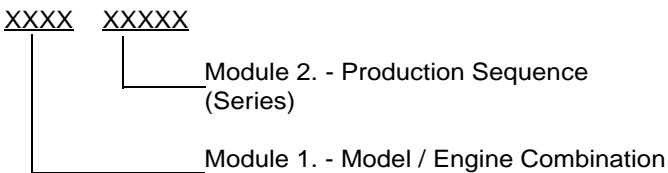

1. The four-digit Model/Engine Combination Module number identifies the model number and engine combination.
2. The five-digit Production Sequence Number identifies the order in which the excavator is produced.

### Engine Serial Number

Figure 2



The engine serial number is located as a plate (Item 1) on the top of the engine [Figure 2].

Figure 3

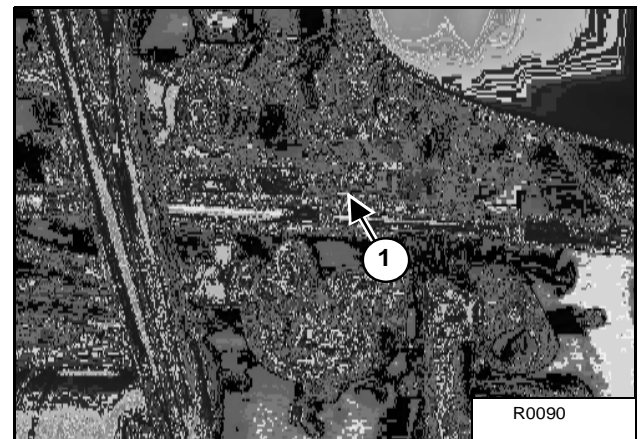

It also appears engraved on the side of the engine (Item 1) [Figure 3].



## DELIVERY REPORT

Figure 4

The image shows a 'DELIVERY REPORT' form with two identical sections. Each section includes a 'WARNING' box with several lines of text and a 'FOR A SAFETY DELIVERY' section with more lines of text. The form is enclosed in a rectangular border, and the number 'B-16315' is printed in the bottom right corner.

The Delivery Report items must be explained to the owner/operator by the dealer. The dealer is to complete the form and the owner/operator signs the form to indicate his understanding [Figure 4].



**BOBCAT EXCAVATOR IDENTIFICATION**

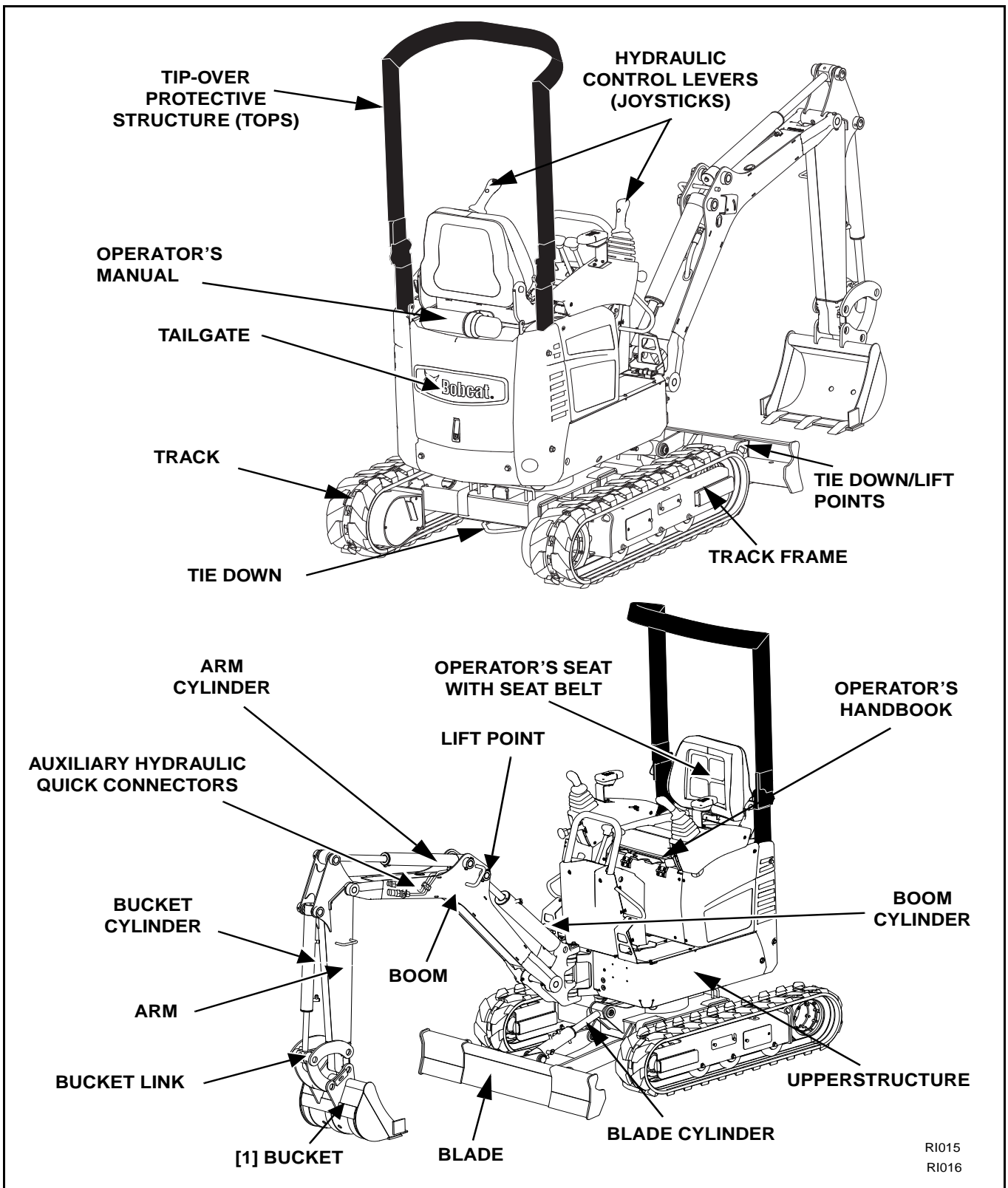

[1] BUCKET - Several different buckets and other attachments are available from the Bobcat Excavator.



## FEATURES, ACCESSORIES, AND ATTACHMENTS

### Standard Features

Model E10 Bobcat Excavator is equipped with the following standard items:

- 710 mm dozer blade / 1100 mm extended
- 180 mm rubber track
- Auxiliary hydraulics
- Control console locks
- Horn
- Hydraulically expandible undercarriage from 710 to 1100 mm
- Retractable seat belt
- Spark arrester muffler
- Suspension seat
- Two speed travel
- \* TOPS canopy
- Vandalism protection
- Working lights

### Options And Accessories

Below is a list of some equipment available from your Bobcat Excavator dealer as Dealer and/or Factory Installed Accessories and Factory Installed Options. See your Bobcat dealer for other available options, accessories and attachments.

- Auxiliary double action
- Beacon
- Demolition kit
- Keyless switch
- Motion alarm
- Strobe

### Attachments

These and other attachments are approved for use on this model Bobcat Excavator. Do not use unapproved attachments. Attachments not manufactured by Bobcat can not be approved.

The versatile Bobcat Excavator quickly turns into a multi-job machine with a variety of attachments.

See your Bobcat dealer for more details on these and other attachments and field accessories.

- Digging bucket
- Grading bucket
- Hydraulic breaker



### OPERATOR CANOPY (TOPS)

The excavator has an operator canopy (TOPS/Tip Over Protective Structure) as standard equipment. The TOPS meets ISO 3471 and ISO 12117.

The canopy provides operator protection if the excavator is tipped over. The seat belt must be worn for TOPS protection.



**Never modify operator cab by welding, grinding, drilling holes or adding attachments unless instructed to do so by Bobcat Company. Changes to the cab can cause loss of operator protection from rollover and falling objects, and result in injury or death.**

W-2069-0200



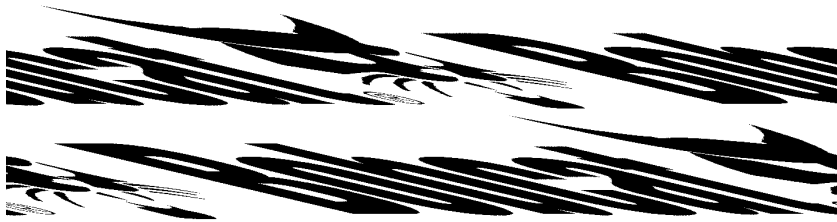



## SAFETY & TRAINING RESOURCES

SAFETY INSTRUCTIONS .....	20
Before Operation .....	20
Safe Operation Is The Operator's Responsibility .....	21
Safe Operation Needs A Qualified Operator .....	21
Avoid Silica Dust .....	22
 FIRE PREVENTION .....	 22
Maintenance .....	22
Operation .....	22
Electrical .....	22
Hydraulic System .....	23
Fueling .....	23
Starting .....	23
Spark Arrester Exhaust System .....	23
Welding And Grinding .....	23
Fire Extinguishers .....	23
 PUBLICATIONS AND TRAINING RESOURCES .....	 24
 SAFETY SIGNS .....	 24
 MACHINE SIGNS (DECALS) .....	 25
1. Thrown Or Flying Objects .....	27
2. Transporting And Lifting .....	27
3. Lift Capacity (Object Handling Applications Excluded) .....	27
4. Crush Hazard .....	28
5. Hot Surfaces .....	28
6. Hot Surfaces And Rotating Fan .....	28
7. High Pressure, Battery, Rotating Fan And Exhaust Gases .....	29
8. General Hazard .....	29



**Bobcat®**



## SAFETY INSTRUCTIONS

### Before Operation

Carefully follow the operating and maintenance instructions in this manual.

The Bobcat excavator is highly maneuverable and compact. It is rugged and useful under a wide variety of conditions. This presents an operator with hazards associated with off motorway, rough terrain applications, common with Bobcat excavator usage.

The Bobcat excavator has an internal combustion engine with resultant heat and exhaust. All exhaust gases can kill or cause illness so use the excavator with adequate ventilation.

The dealer explains the capabilities and restrictions of the Bobcat excavator and attachment for each application. The dealer demonstrates the safe operation according to Bobcat instructional materials, which are also available to operators. The dealer can also identify unsafe modifications or use of unapproved attachments. The attachments and buckets are designed for a Rated Lift Capacity. They are designed for secure fastening to the Bobcat excavator. The user must check with the dealer, or Bobcat literature, to determine safe loads of materials of specified densities for the machine - attachment combination.

The following publications and training materials provide information on the safe use and maintenance of the Bobcat machine and attachments:

- The Delivery Report is used to assure that complete instructions have been given to the new owner and that the machine and attachment is in safe operating condition.
- The Operation & Maintenance Manual delivered with the machine or attachment gives operating information as well as routine maintenance and service procedures. It is a part of the machine and can be stored in a container provided on the machine. Replacement Operation & Maintenance Manuals can be ordered from your Bobcat dealer.
- Machine signs (decals) instruct on the safe operation and care of your Bobcat machine or attachment. The signs and their locations are shown in the Operation & Maintenance Manual. Replacement signs are available from your Bobcat dealer.
- An Operator's Handbook is fastened to the operator cab of the excavator. Its brief instructions are convenient to the operator. See your Bobcat dealer for more information on translated versions.

The dealer and owner / operator review the recommended uses of the product when delivered. If the owner / operator will be using the machine for a different application(s) he or she must ask the dealer for recommendations on the new use.



**SAFETY INSTRUCTIONS (CONT'D)**

**Safe Operation Is The Operator's Responsibility**

	<p><b>Safety Alert Symbol</b></p>
<p>This symbol with a warning statement means:  <b>"Warning, be alert! Your safety is involved!"</b>                  Carefully read the message that follows.</p>	



**WARNING**

**Operator must have instructions before operating the machine. Untrained operators can cause injury or death.**

W-2001-0502

**IMPORTANT**

**This notice identifies procedures which must be followed to avoid damage to the machine.**

I-2019-0284



**DANGER**

**The signal word DANGER on the machine and in the manuals indicates a hazardous situation which, if not avoided, will result in death or serious injury.**

D-1002-1107



**WARNING**

**The signal word WARNING on the machine and in the manuals indicates a potentially hazardous situation which, if not avoided, could result in death or serious injury.**

W-2044-1107

The Bobcat excavator and attachment must be in good operating condition before use.

Check all of the items on the Bobcat Service Schedule Decal under the 8-10 hour column or as shown in the Operation & Maintenance Manual.

**Safe Operation Needs A Qualified Operator**

For an operator to be qualified, he or she must not use drugs or alcoholic drinks which impair alertness or coordination while working. An operator who is taking prescription drugs must get medical advice to determine if he or she can safely operate a machine.

*A Qualified Operator Must Do The Following:*

*Understand the Written Instructions, Rules and Regulations*

- The written instructions from Bobcat Company include the Delivery Report, Operation & Maintenance Manual, Operator's Handbook and machine signs (decals).
- Check the rules and regulations at your location. The rules may include an employer's work safety requirements. For driving on public roads, the machine must be equipped as stipulated by the local regulations authorising operation on public roads in your specific country. Regulations may identify a hazard such as a utility line.

*Have Training with Actual Operation*

- Operator training must consist of a demonstration and verbal instruction. This training is given by your Bobcat dealer before the product is delivered.
- The new operator must start in an area without bystanders and use all the controls until he or she can operate the machine and attachment safely under all conditions of the work area. Always fasten seat belt before operating.

*Know the Work Conditions*

- Know the weight of the materials being handled. Avoid exceeding the Rated Lift Capacity of the machine. Material which is very dense will be heavier than the same volume of less dense material. Reduce the size of load if handling dense material.
- The operator must know any prohibited uses or work areas, for example, he or she needs to know about excessive slopes.
- Know the location of any underground lines.
- Wear tight fitting clothing. Always wear safety glasses when doing maintenance or service. Safety glasses, respiratory equipment, hearing protection or Special Applications Kits are required for some work. See your Bobcat dealer about Bobcat Safety Equipment for your model.



**SAFETY INSTRUCTIONS (CONT'D)**

**Avoid Silica Dust**



Cutting or drilling concrete containing sand or rock containing quartz may result in exposure to silica dust. Use a respirator, water spray or other means to control dust.

**FIRE PREVENTION**

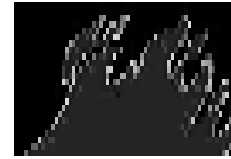

**Maintenance**

The machine and some attachments have components that are at high temperatures under normal operating conditions. The primary source of high temperatures is the engine and exhaust system. The electrical system, if damaged or incorrectly maintained, can be a source of arcs or sparks.

Flammable debris (leaves, straw, etc.) must be removed regularly. If flammable debris is allowed to accumulate, it can cause a fire hazard. Clean often to avoid this accumulation. Flammable debris in the engine compartment is a potential fire hazard.

The operator's area, engine compartment and engine cooling system must be inspected every day and cleaned if necessary to prevent fire hazards and overheating.

All fuels, most lubricants and some coolants mixtures are flammable. Flammable fluids that are leaking or spilled onto hot surfaces or onto electrical components can cause a fire.

**Operation**

Do not use the machine where exhaust, arcs, sparks or hot components can contact flammable material, explosive dust or gases.

**Electrical**



Check all electrical wiring and connections for damage. Keep the battery terminals clean and tight. Repair or replace any damaged part or wires that are loose or frayed.

Battery gas can explode and cause serious injury. Use the procedure in the Operation & Maintenance Manual for connecting the battery and for jump starting. Do not jump start or charge a frozen or damaged battery. Keep any open flames or sparks away from batteries. Do not smoke in battery charging area.

**FIRE PREVENTION (CONT'D)**

**Hydraulic System**

Check hydraulic tubes, hoses and fittings for damage and leakage. Never use open flame or bare skin to check for leaks. Hydraulic tubes and hoses must be properly routed and have adequate support and secure clamps. Tighten or replace any parts that show leakage.

Always clean fluid spills. Do not use petrol or diesel fuel for cleaning parts. Use commercial non-flammable solvents.

**Fueling**



Stop the engine and let it cool before adding fuel. No smoking! Do not refuel a machine near open flames or sparks. Fill the fuel tank outdoors.

**Starting**

Do not use ether or starting fluids on any engine that has glow plugs. These starting aids can cause explosion and injure you or bystanders.

Use the procedure in the Operation & Maintenance Manual for connecting the battery and for jump starting.

**Spark Arrester Exhaust System**

The spark arrester exhaust system is designed to control the emission of hot particles from the engine and exhaust system, but the muffler and the exhaust gases are still hot.

Check the spark arrester exhaust system regularly to make sure it is maintained and working properly. Use the procedure in the Operation & Maintenance Manual for cleaning the spark arrester muffler (if equipped).

**Welding And Grinding**

Always clean the machine and attachment, disconnect the battery, and disconnect the wiring from the Bobcat controllers before welding. Cover rubber hoses, battery and all other flammable parts. Keep a fire extinguisher near the machine when welding.

Have good ventilation when grinding or welding painted parts. Wear dust mask when grinding painted parts. Toxic dust or gas can be produced.

Dust generated from repairing non-metallic parts such as hoods, fenders or covers can be flammable or explosive. Repair such components in a well ventilated area away from open flames or sparks.

**Fire Extinguishers**



Know where fire extinguishers and first aid kits are located and how to use them. Inspect the fire extinguisher and service the fire extinguisher regularly. Obey the recommendations on the instructions plate.

**PUBLICATIONS AND TRAINING RESOURCES**

The following publications are also available for your Bobcat excavator. You can order them from your Bobcat dealer.

For the latest information on Bobcat products and the Bobcat Company, visit our web site at [www.bobcat.com](http://www.bobcat.com); you can also order Operator and Service Training materials online through [www.bobcatstore.com](http://www.bobcatstore.com)

**SAFETY SIGNS**

Safety signs are used to alert the equipment operator or service person to hazards that can be encountered in the use and maintenance of the equipment. The location and description of the safety signs are detailed in this section. Please become familiarised with all safety signs installed on the Compact Excavator.

The format for these safety signs is shown below:



**OPERATION & MAINTENANCE MANUAL**

6986787

- Complete instructions on the correct operation and the routine maintenance of the Bobcat excavator.



**SERVICE MANUAL**

6986788

- Complete maintenance instructions for your Bobcat excavator.



**OPERATOR'S HANDBOOK**

6986963

Gives basic operation instructions and safety warnings

**Vertical configuration**



**Horizontal configuration**







**MACHINE SIGNS (DECALS)**

Follow the instructions on all the Machine Signs (Decals) that are on the excavator. Replace any damaged machine signs and be sure they are in the correct locations. Machine signs are available from your Bobcat Excavator dealer.

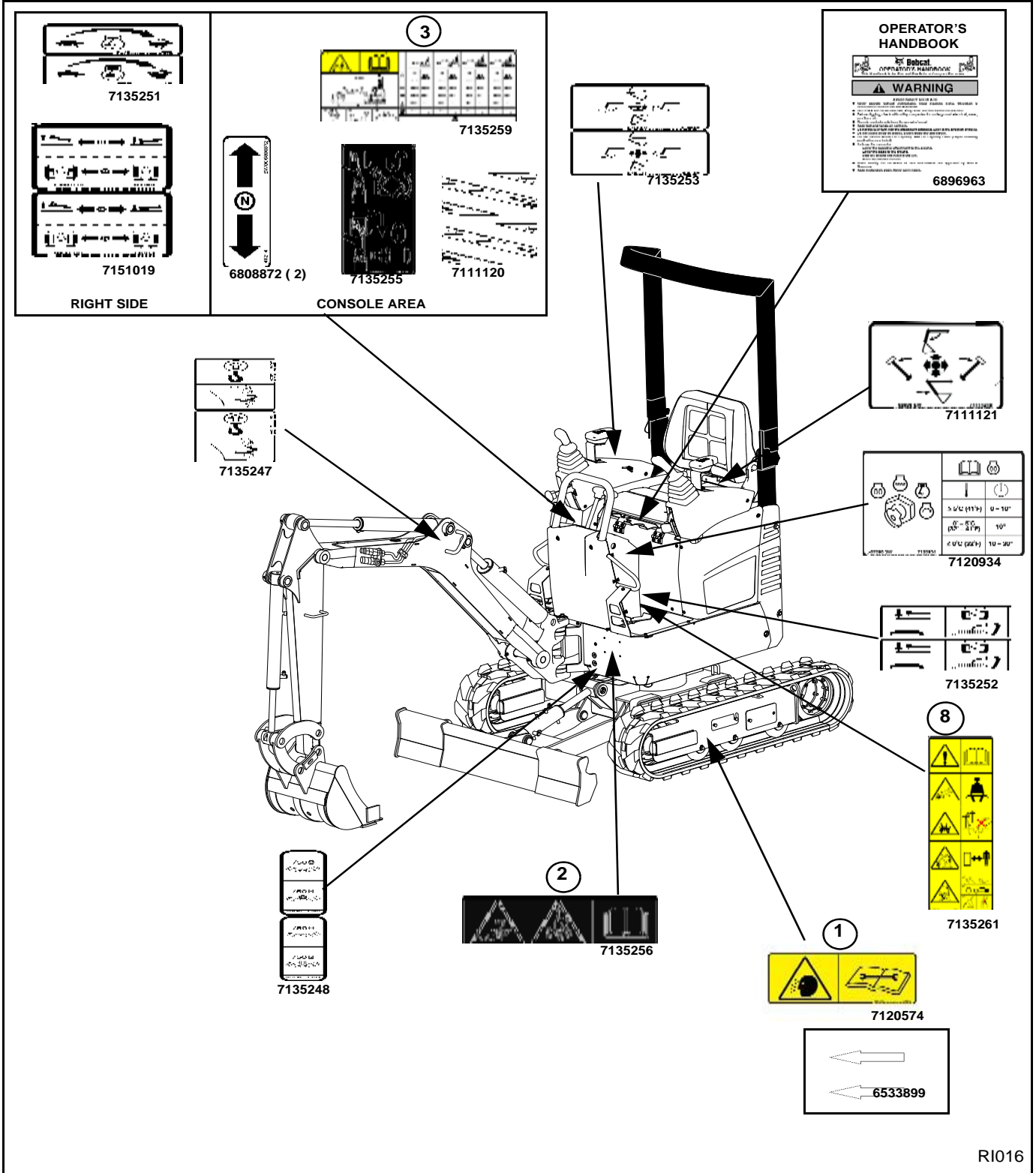

RI016



**MACHINE SIGNS (DECALS) (CONT'D)**

Follow the instructions on all the Machine Signs (Decals) that are on the excavator. Replace any damaged machine signs and be sure they are in the correct locations. Machine signs are available from your Bobcat Excavator dealer.

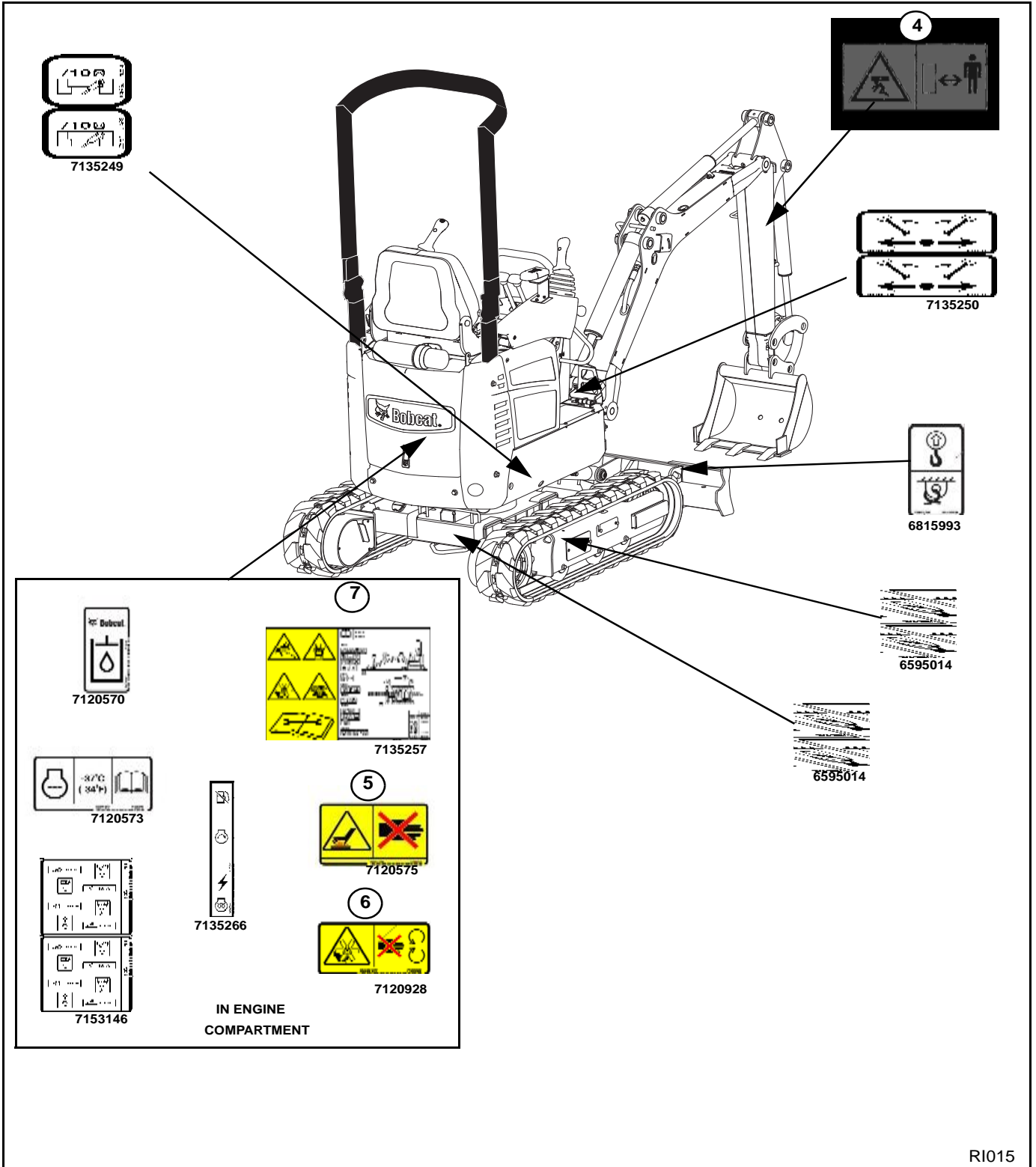



**MACHINE SIGNS (DECALS) (CONT'D)**

**NOTE:** See the numbered **MACHINE SIGNS (DECALS)** on page 25 and **MACHINE SIGNS (DECALS) (CONT'D)** on page 26 for the machine location of each corresponding numbered no-text decals as shown below.

**1. Thrown Or Flying Objects**

This safety sign is located on the outside of both tracks.

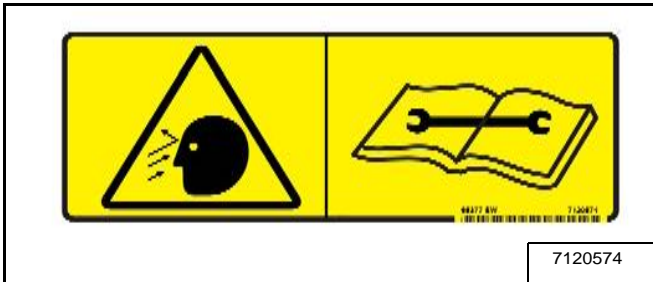

High pressure grease can cause serious injury. Do not loosen grease fitting. Do not loosen bleed fitting more than 1 - 1/2 turns. Read and understand the Operation & Maintenance Manual for more information.

W-2516-0106

**2. Transporting And Lifting**

This safety sign is located on the front of the canopy.

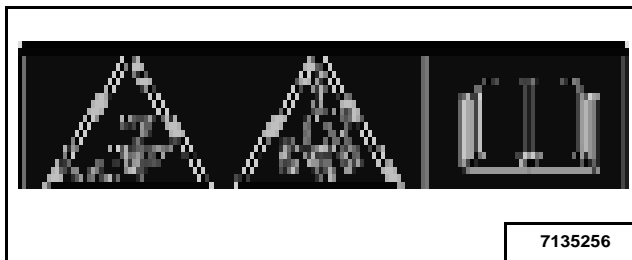

Improper loading, transporting and lifting procedures can cause serious injury or death. Read and understand the Operation & Maintenance Manual prior to transporting or lifting the machine.

W-2517-0106

**3. Lift Capacity (Object Handling Applications Excluded)**

This safety sign is located inside the operator's area.



Overload can tip the excavator and cause serious injury or death.

- Do not lift or hold any load that exceeds these ratings at their specific load radii and height.
- Total rated load is shown. The weight of all lifting devices must be deducted to determine the net load that can be lifted.

Read and understand the Operation & Maintenance Manual for more information.

W-2519-0106

**MACHINE SIGNS (DECALS) (CONT'D)**

**4. Crush Hazard**

This safety sign is located on both sides of the boom.

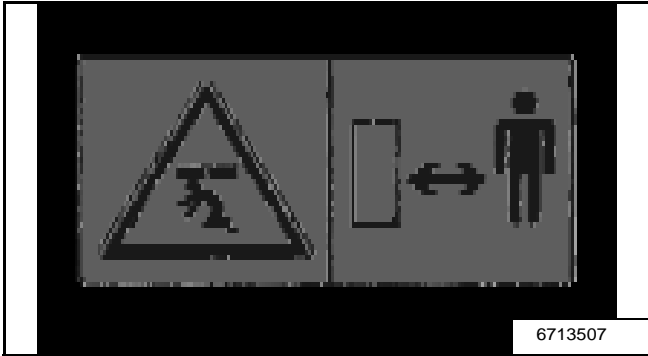

Keep away from the operating machine to avoid serious injury or death.

W-2520-0106

**5. Hot Surfaces**

This safety sign is located inside the engine compartment.



**AVOID BURNS**

Do not remove radiator cap when the engine is hot. You can be seriously burned.

W-2070-1203

**6. Hot Surfaces And Rotating Fan**

This safety sign is located inside the engine compartment.

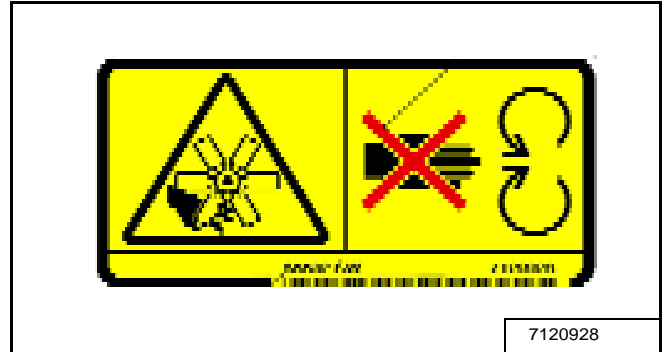

Rotating fan blade can cause serious injury or death. Keep away from fan and moving parts. Do not operate with guard removed. Hot surfaces can cause injury. Do not touch. Allow to cool before servicing.

W-2521-0106



**MACHINE SIGNS (DECALS) (CONT'D)**

**7. High Pressure, Battery, Rotating Fan And Exhaust Gases**

This safety sign is located inside the engine compartment.

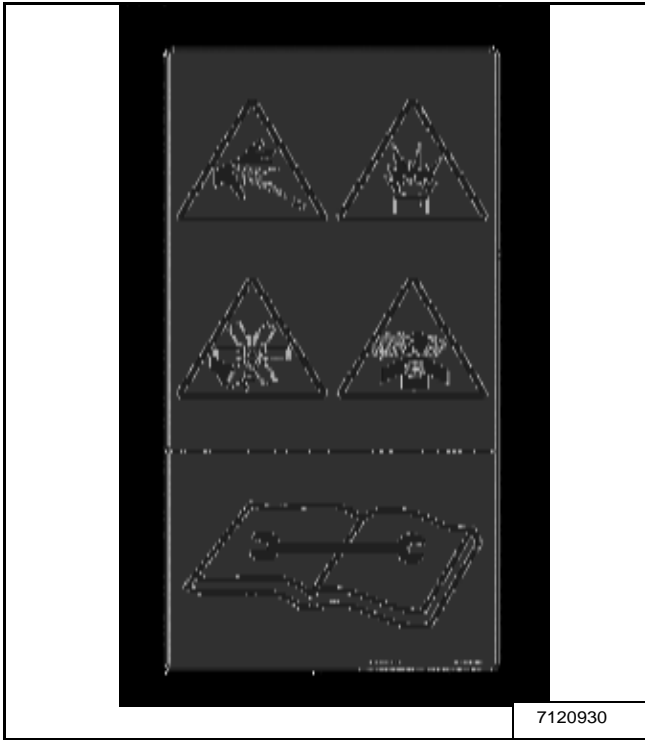

Leaking fluids under pressure can enter the skin and cause serious injury or death. Immediate medical attention is required. Wear goggles. Use cardboard to check for leaks.

Battery makes flammable and explosive gas. Keep arcs, sparks, flames and lighted tobacco away. Keep away from electrical contacts.

Rotating fan can cause serious injury. Keep away from fan and moving parts. Do not operate with guard removed.

All exhaust gases can kill. Always ventilate. Read and understand the Operation & Maintenance Manual for more information.

W-2522-0106

**8. General Hazard**

This safety sign is located inside the operator's area.



Failure to obey warning signs and instructions can cause serious injury or death. Never use excavator without training. Read and understand the Operation & Maintenance Manual and Handbook.

Keep away from drop-offs, steep areas or banks that could collapse.

Explosion or electrocution can occur if the machine makes contact with utility lines or pipes. Check for overhead or underground lines before operating.

Keep onlookers away. No riders. Check location of blade for direction of travel before operating steering controls.

Failure to operate machine from the operator's position can cause serious injury or death.

To Exit Excavator:

1. Lower attachment and blade to ground.
2. Stop engine and remove the key (if equipped).
3. Raise control console.

W-2518-0106



## OPERATING INSTRUCTIONS

INSTRUMENTS AND CONTROLS .....	32
Instrumentation .....	32
Operator Controls .....	32
CONTROL LOCKOUT CONSOLES .....	33
Raising And Lowering The Console(s) .....	33
ENGINE SPEED CONTROL .....	33
Operation .....	33
Two-Speed Travel .....	33
TAILGATE .....	34
Opening And Closing The Tailgate .....	34
OPERATOR CANOPY .....	35
TOPS Approved .....	35
Lowering The TOPS Canopy .....	35
Raising The TOPS Canopy .....	35
STEERING LEVERS .....	36
Driving Forward And Reversing .....	36
Turning .....	36
HYDRAULIC CONTROLS .....	38
Control Joysticks .....	38
Control Joystick Lock .....	39
Auxiliary Hydraulic Pedal .....	39
Boom Swing Pedal .....	40
Quick Connectors .....	40
BLADE CONTROL .....	41
Blade/Track Expansion Lever .....	41
Raising And Lowering The Blade .....	41
TRACK FRAME EXPANSION .....	42
Expanding And Retracting The Tracks .....	42
UPPERSTRUCTURE SLEW LOCK .....	43
DAILY INSPECTION .....	44
Daily Inspection And Maintenance .....	44
PRE-STARTING PROCEDURE .....	45
Before Starting The Engine .....	45
STARTING THE ENGINE .....	46
Cold Temperature Starting Procedure .....	47
BUCKETS AND ATTACHMENTS .....	48
Installing .....	48
Removing .....	48



OPERATING PROCEDURE .....	49
Inspecting The Work Area .....	49
Lowering The Work Equipment (Engine STOPPED).....	49
Driving On Public Roads .....	49
Excavating .....	50
Boom Swing .....	51
Backfilling .....	52
Driving The Excavator .....	52
Operating On Slopes .....	53
Operating In Water .....	55
Avoiding Track Damage.....	55
 PARKING THE EXCAVATOR .....	 56
 LIFTING THE EXCAVATOR .....	 56
 TRANSPORTING THE EXCAVATOR.....	 57
Loading Onto Transport Vehicle .....	57
Fastening To Transport Vehicle .....	58

**INSTRUMENTS AND CONTROLS**

**Instrumentation**

**Figure 5**

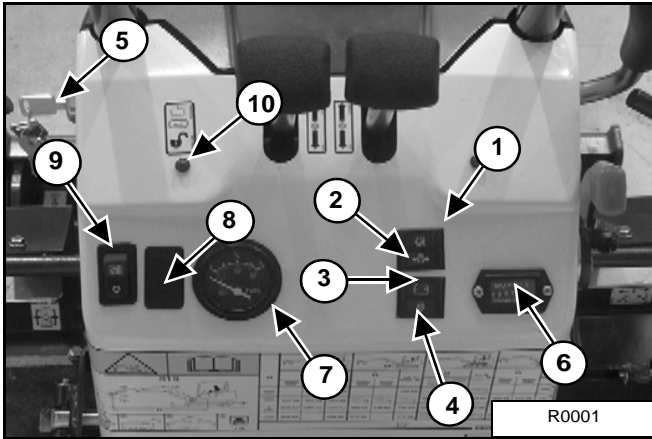

All the instruments are located on the control console [Figure 5].

REF	DESCRIPTION	FUNCTION
1	Engine Coolant Temperature Warning Lamp	Light comes ON when coolant temperature is above allowable range. Alarm also sounds. STOP the engine if light comes ON.
2	Engine Oil Pressure Warning Lamp	Light comes ON when pressure is below allowable range. Alarm also sounds. STOP the engine if light comes ON.
3	Charging system Lamp	Light comes ON when the alternator is NOT charging the battery.
4	Glow Plug Indicator Lamp	Light comes ON when key is turned in PREHEAT position
5	Key Start Switch	Used to activate glow plugs, start and stop engine.
6	Hourmeter	Records the total operating hours of the machine.
7	Fuel Gauge	Shows the amount of fuel in the tank.
8	Not used	- - -
9	Boom Light	Lightens the working area.
10	Hydraulic Lockout Indicator Lamp	Light comes ON when hydraulic lockout is ON.

**Operator Controls**

**Figure 6**

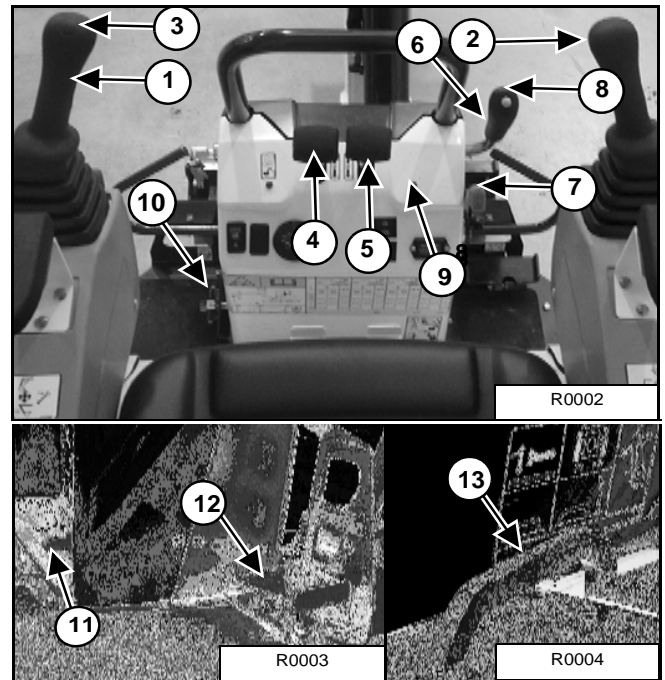

REF	DESCRIPTION	FUNCTION
1	Left Hand Control Joystick	See "Control Joysticks" on page 38.
2	Right Hand Control Joystick	See "Control Joysticks" on page 38.
3	Horn	
4	Left Steering Lever	See "Left Turn" on page 37.
5	Right Steering Lever	See "Right Turn" on page 36.
6	Blade/Track Expansion Lever	See "Raising And Lowering The Blade" on page 41.
7	Engine Speed Control Lever	See "ENGINE SPEED CONTROL" on page 33.
8	Two-Speed Button	See "Two-Speed Travel" on page 33.
9	High Range Indicator	
10	Auxiliary Hydraulic Pedal	See "Auxiliary Hydraulic Pedal" on page 39.
11	Upperstructure Slew Lock	See "UPPERSTRUCTURE SLEW LOCK" on page 43.
12	Boom Swing Pedal	See "Boom Swing Pedal" on page 40.
13	Blade/Track Expansion Selector	See "Blade/Track Expansion Lever" on page 41.



## CONTROL LOCKOUT CONSOLES

### Raising And Lowering The Console(s)

Figure 7

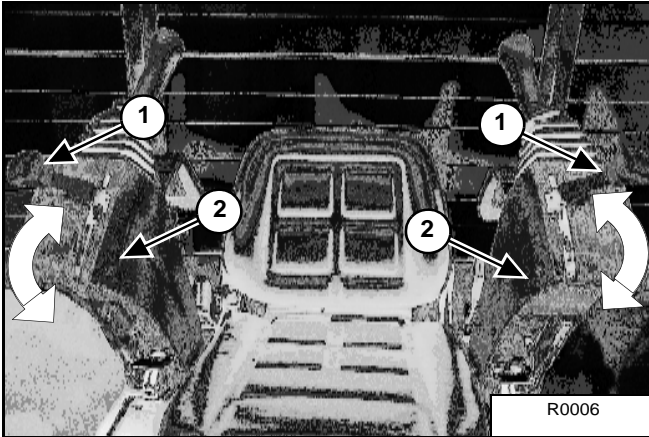

Pull the control lockout lever(s) (Item 1) [Figure 7] up to release and raise the console(s) (Item 2) to provide entry and exit from the canopy.

**NOTE: When either console is raised, the hydraulic control joysticks and the traction system are locked and will not function.**

Before operating the machine, lower the control lockout consoles (Item 2) [Figure 7] by pushing the control lockout lever(s) (Item 1) until latched in the down position.

Figure 8

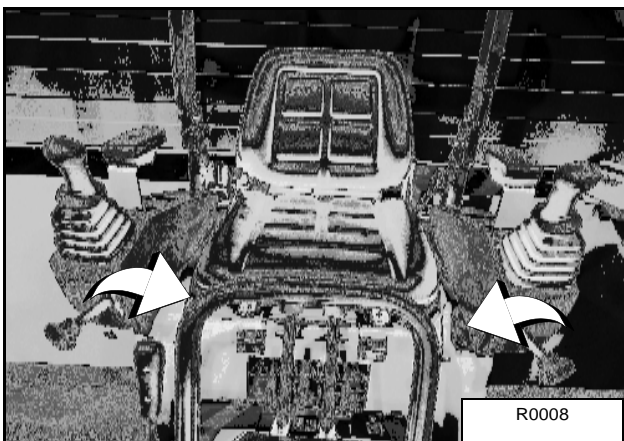

The control lockout consoles can be narrowed [Figure 8] to match the tracks' width or to improve operator comfort. Raise the control lockout lever(s) (Item 1) [Figure 7] and pull them closer to the operator seat.

## ENGINE SPEED CONTROL

### Operation

Figure 9

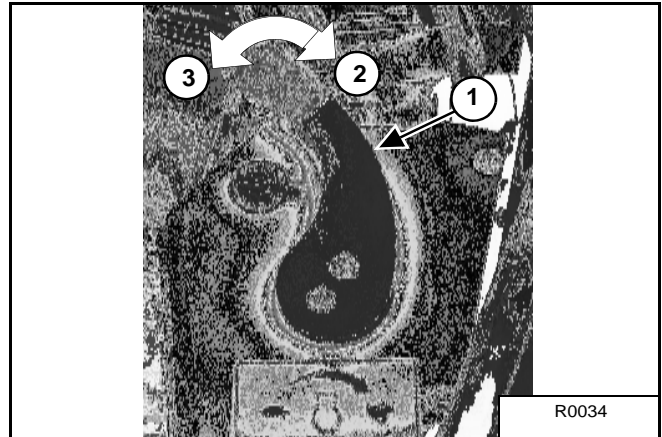

The engine speed control lever (Item 1) [Figure 9] controls the RPM of the engine.

Push (Item 2) the lever to increase engine RPM; pull (Item 3) to decrease RPM [Figure 9].

### Two-Speed Travel

Figure 10

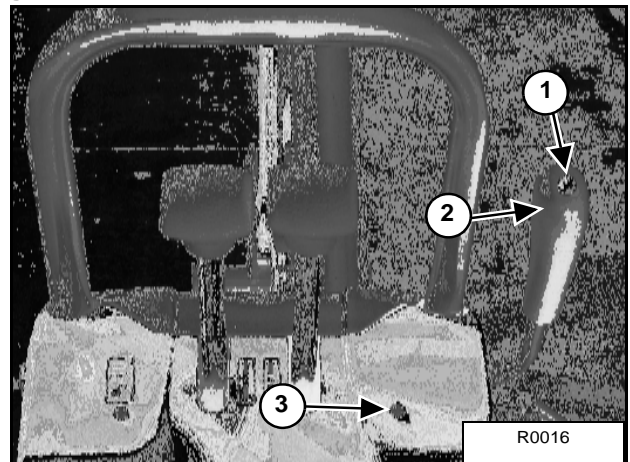

Press the button (Item 1) on the blade/track width control lever (Item 2) to engage the high-range.

Press the button again to disengage.

The green light (Item 3) will be ON when high-range is engaged [Figure 10].

Press the button again to disengage.

**TAILGATE**

**Opening And Closing The Tailgate**

**Figure 11**



Release the latch (Item 1) and pull the tailgate open [Figure 11].

**Figure 12**

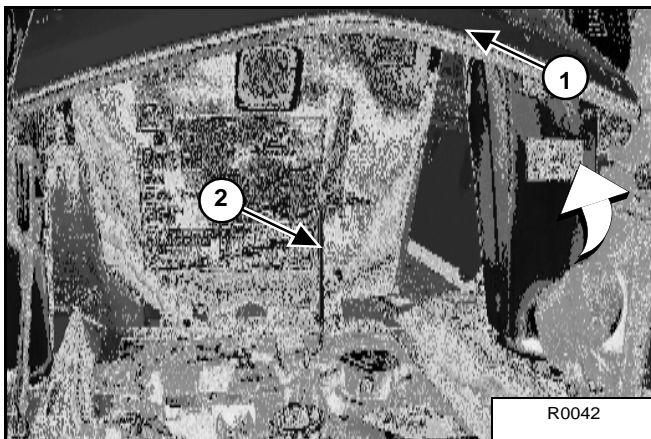

Pull the tailgate (Item 1) till blocking the wedge (Item 2) [Figure 12].

To close the tailgate, carefully pull the wedge, handling the tailgate, and then close it until the latch is closed again.

**NOTE:** The tailgate can be locked using the start key.

**OPERATOR CANOPY**

TOPS Approved

**Figure 13**

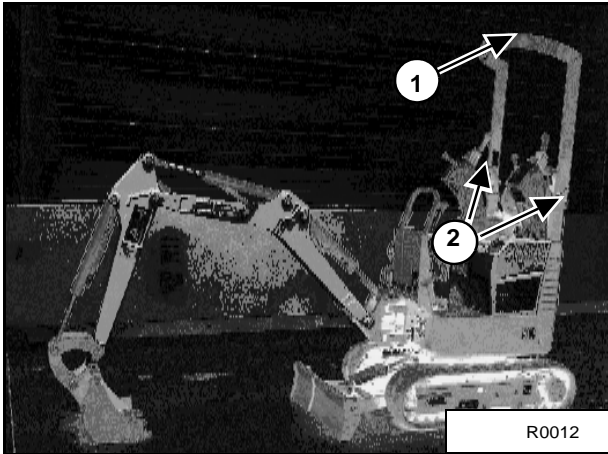

The excavator has an operator canopy (TOPS) (Tip Over Protective Structure) (Item 1) (meets ISO 12117) as standard equipment [Figure 13].

The canopy provides operator protection if the excavator tips over. The seat belt must be worn for TOPS protection.

**Lowering The TOPS Canopy**

Lowering the TOPS canopy allows to reduce the machine height in order to pass through small doors.

**Figure 14**

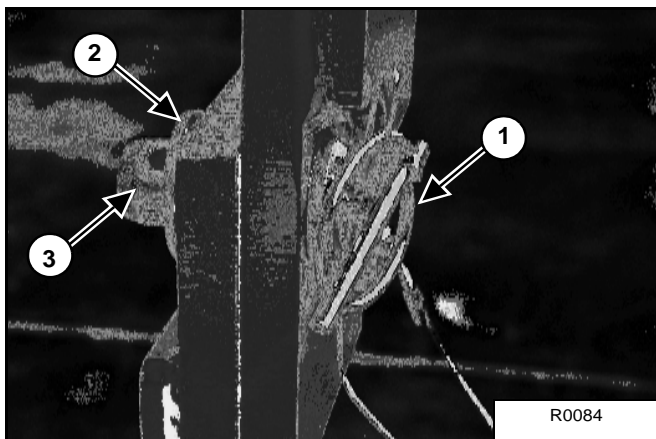

Remove the clip (Item 1), the washer (Item 2) and the spindle (Item 3) [Figure 14] on both sides of the canopy (Item 2) [Figure 13].

**Figure 15**

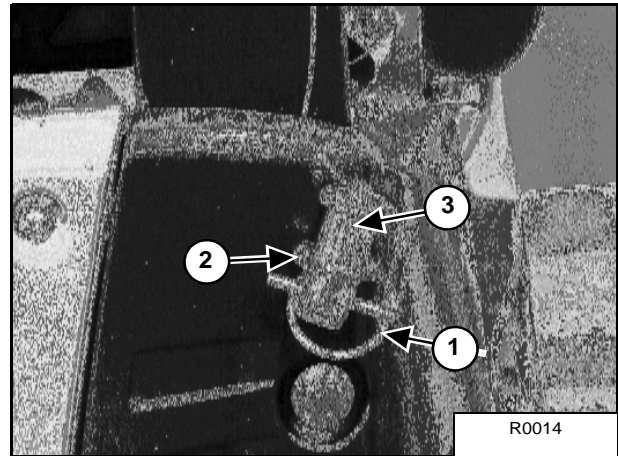

Keep the clip (Item 1) and the washer (Item 2) within the spindle (Item 3) [Figure 15]

**Figure 16**

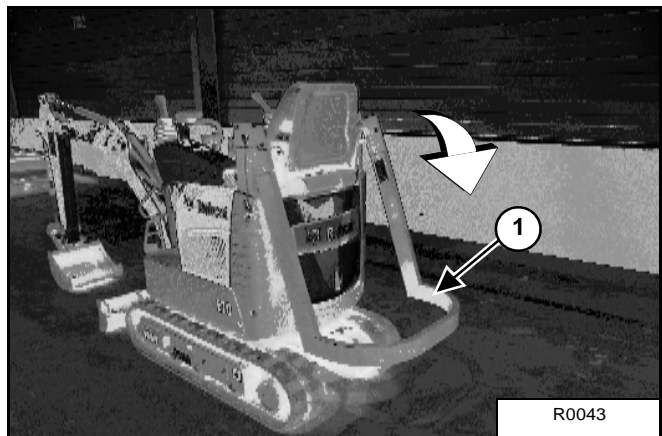

Lower the canopy (Item 1) [Figure 16].

**Raising The TOPS Canopy**

To raise the TOPS canopy, follow the same procedure in reverse.

## STEERING LEVERS

### Driving Forward And Reversing

**NOTE:** The following procedures describe forward, reverse, left and right as seated in the operator's seat.

Figure 17

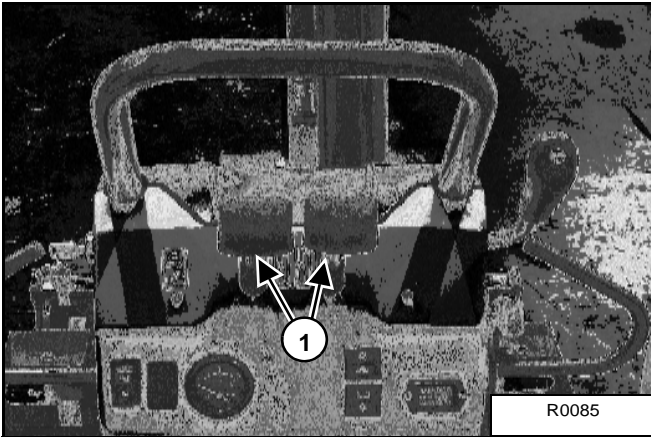

Position the blade at the front of the machine (as you sit in the operator's seat). Slowly move both steering levers (Item 1) [Figure 17] forward for forward travel; backward for reverse travel.

## Turning

### Right Turn

Figure 18

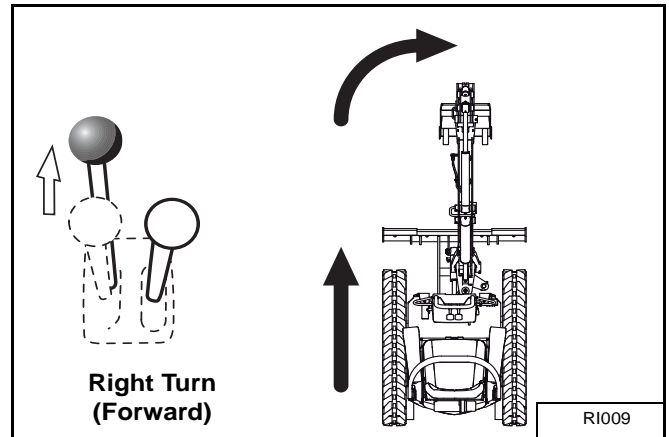

Push the left steering lever forward to turn right [Figure 18] while driving forward.

Figure 19

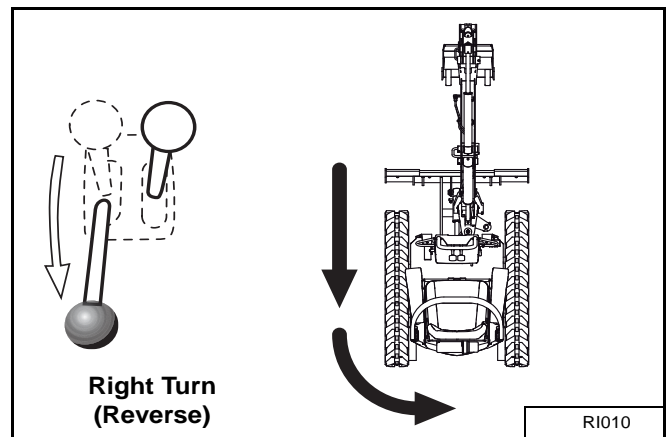

Pull the left steering lever backward to turn right [Figure 19] while reversing.

**STEERING LEVERS (CONT'D)**

**Turning (Cont'd)**

*Counter-Rotation Right Turn*

**Figure 20**

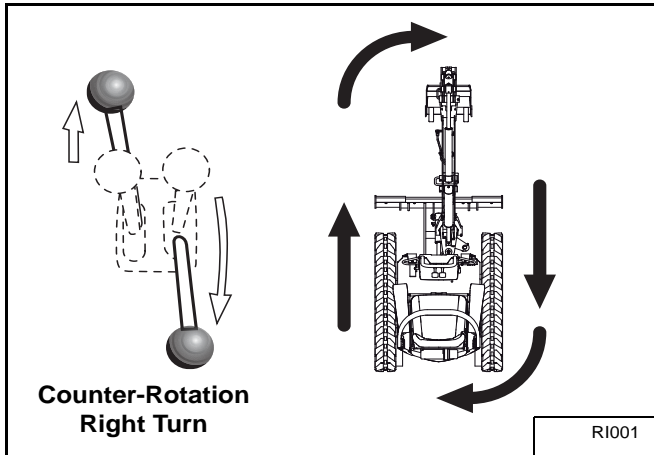

Push the left steering lever forward and pull the right steering lever backward [Figure 20].

*Left Turn*

**Figure 21**

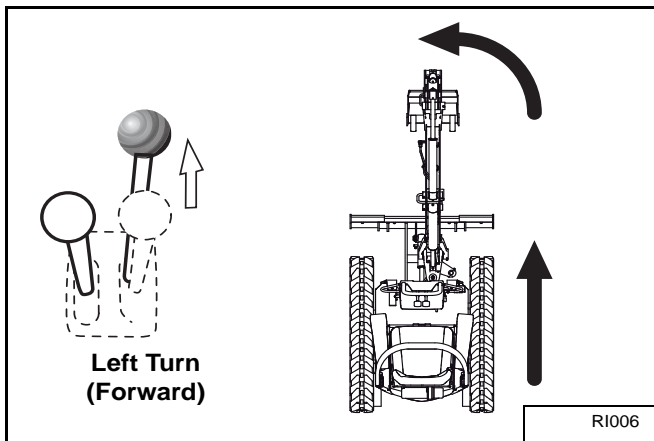

Push the right steering lever forward to turn left [Figure 21] while driving forward.

**Figure 22**

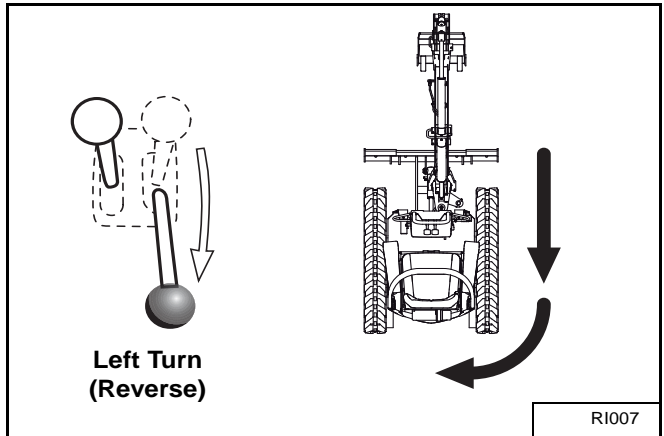

Pull the right steering lever backward to turn left while reversing [Figure 22].

*Counter-Rotation Left Turn*

**Figure 23**

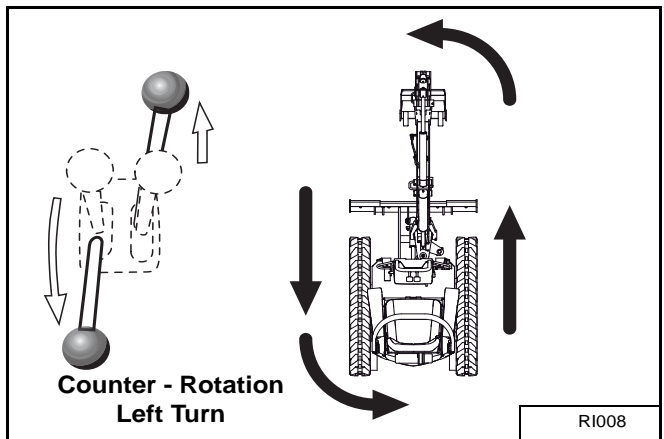

Push the right steering lever forward and pull the left steering lever backward [Figure 23].

**HYDRAULIC CONTROLS**

**Control Joysticks**

*Left Control Joystick*

**Figure 24**

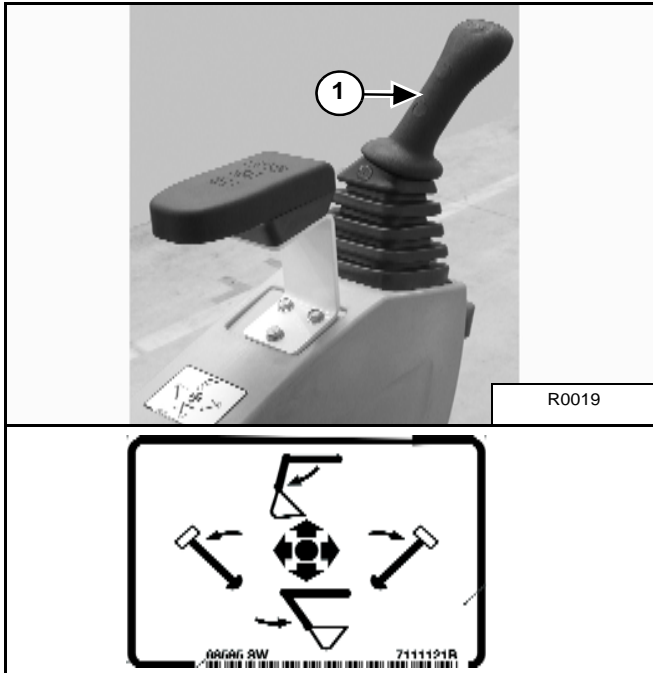

The work equipment (boom, arm, bucket, and upperstructure slew) is operated by using the left and right control joysticks [Figure 24] & [Figure 25].

The left control joystick (Item 1) is used to operate the arm and slew the upperstructure [Figure 24].

1. Arm out.
2. Arm out and slew right.
3. Slew right.
4. Arm in and slew right.
5. Arm in.
6. Arm in and slew left.
7. Slew left.
8. Arm out and slew left.

**IMPORTANT**

**Before slewing the upperstructure, make sure the slew lock is disengaged.**

I-2051-0905

*Right Control Joystick*

**Figure 25**

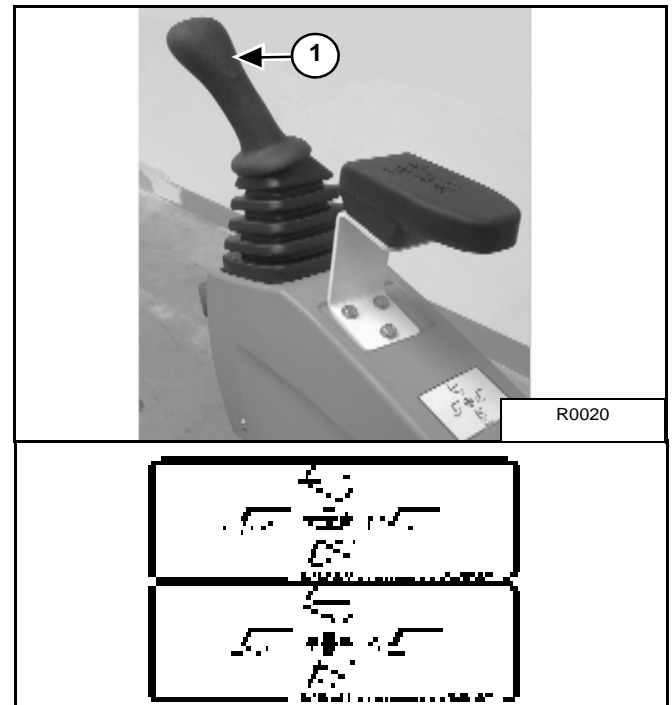

The right control joystick (Item 1) is used to operate the boom and bucket [Figure 25].

1. Boom lower.
2. Boom lower and bucket dump.
3. Bucket dump.
4. Boom raise and bucket dump.
5. Boom raise.
6. Boom raise and bucket curl.
7. Bucket curl.
8. Boom lower and bucket curl.

**! WARNING**

**AVOID INJURY OR DEATH**

**Before leaving the machine:**

- Lower the work equipment to the ground.
- Lower the blade to the ground.
- Stop the engine & remove the key.

W-2196-0595

## HYDRAULIC CONTROLS (CONT'D)

### Control Joystick Lock

Figure 26

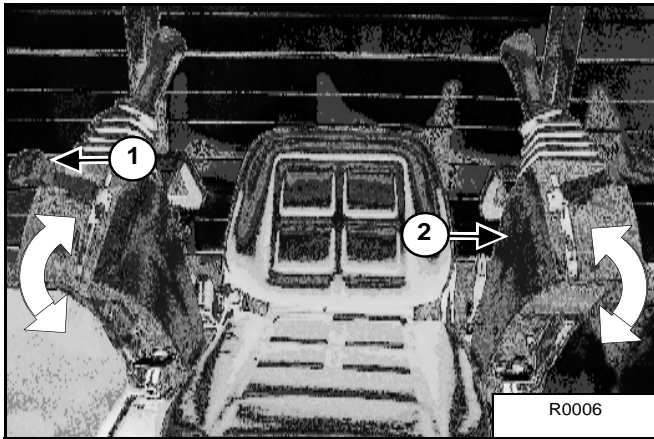

The control lock lever (Item 1) [Figure 26] disengages the hydraulic control functions from the control joysticks when either console is raised.

**NOTE: If the engine stops, the boom/bucket (attachments) can be lowered to the ground using hydraulic pressure in the accumulator. The control console(s) must be in the locked down position, and the key switch in the ON position. Use the control lever to lower the boom.**

Lower the control console(s) (Item 2) [Figure 26] to engage the hydraulic control functions of the control joysticks.

### Auxiliary Hydraulic Pedal

The left pedal controls attachments (such as a hydraulic breaker) when mounted on the arm.

Figure 27

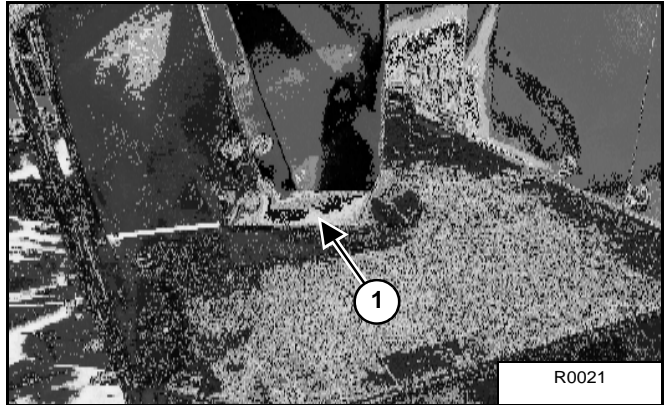

Press the auxiliary hydraulics pedal (Item 1) [Figure 27] to provide hydraulic pressure to the top hydraulic line. Release the pedal to stop hydraulic flow.

Only the top auxiliary line is pressurised. The bottom line is for return oil flow.

Figure 28

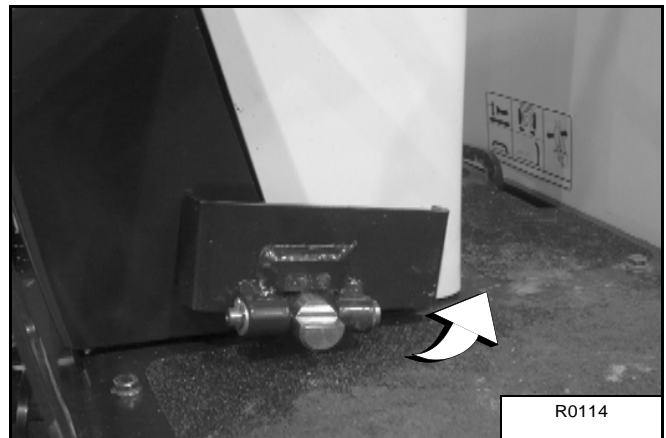

When you are not using the auxiliary flow, the pedal can be folded to prevent operation of the hydraulic functions [Figure 28].

## HYDRAULIC CONTROLS (CONT'D)

### Boom Swing Pedal

Figure 29

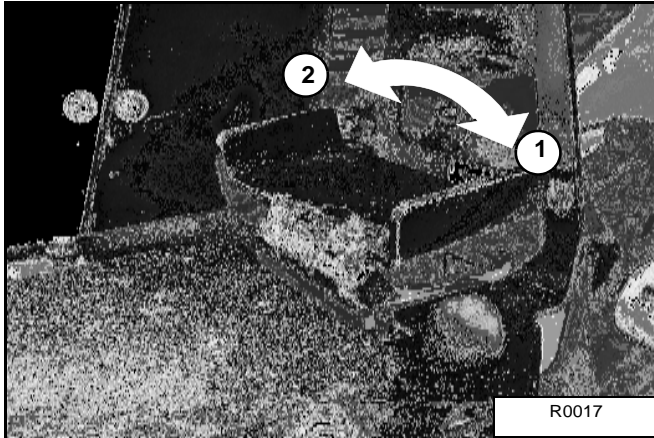

The boom swing pedal is located at the right side of the control console [Figure 29].

Press the right side (Item 1) [Figure 29] of the pedal to swing the boom to the right.

Press the left side (Item 2) [Figure 29] of the pedal to swing the boom to the left.

Figure 30



When not in use, the boom swing pedal can be folded inward to prevent operation of the boom swing function. In this position it can be used as a footrest [Figure 30].

### Quick Connectors

Figure 31

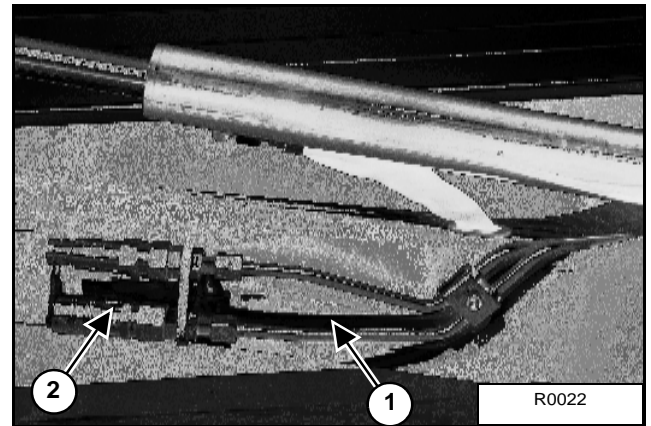

Excavators have auxiliary hydraulic lines (Item 1) [Figure 31] located on the boom.

Quick connectors (Item 2) [Figure 31] are available for use with hydraulically controlled attachments.

## WARNING

### AVOID BURNS

Hydraulic fluid, tubes, fittings and quick couplers can get hot when running machine and attachments. Be careful when connecting and disconnecting quick couplers.

W-2220-0396

**NOTE:** With the engine stopped and the attachment flat on the ground, move the left pedal back and forth several times. This relieves pressure that can be trapped in the auxiliary circuit.



## HYDRAULIC CONTROLS (CONT'D)

### Quick Connectors (Cont'd)

#### To Connect:

Clean the surface and the outside diameter of both the male and female connectors. Replace connectors that show signs of corroding, cracking, damage, or excessive wear [Figure 31].

Install the male connector into the female connector. Full connection is made when the ball release sleeve slides forward on the female connector.

#### To Disconnect:

**Figure 32**

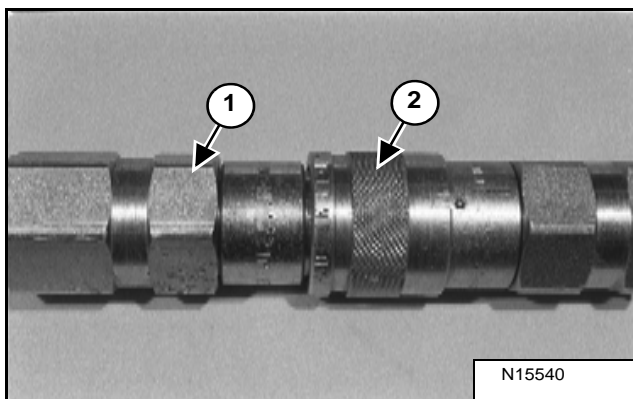

Hold the male connector (Item 1). Pull back the sleeve (Item 2) [Figure 32] on the female connector until the connectors disconnect.

## BLADE CONTROL

### Blade/Track Expansion Lever

**Figure 33**

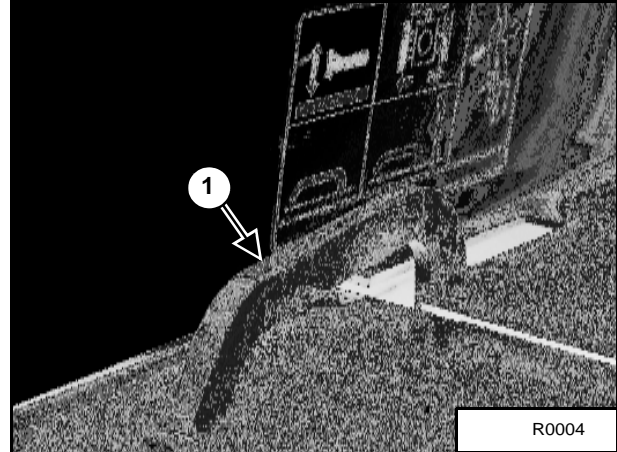

Lower the blade/track expansion lever (Item 1) [Figure 33] into the blade position.

### Raising And Lowering The Blade

**Figure 34**

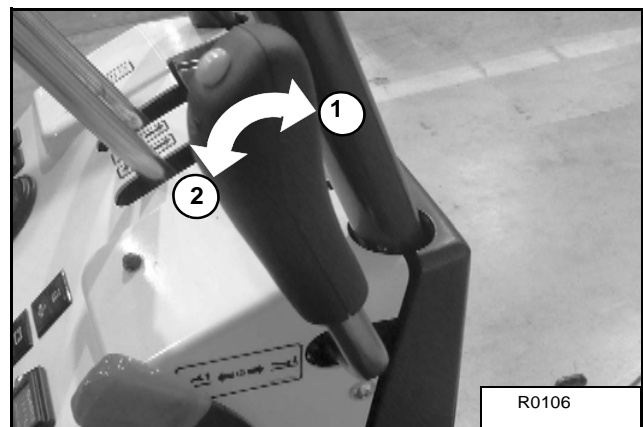

Push the lever forward (Item 1) [Figure 34] to lower the blade.

Pull the lever backward (Item 2) [Figure 34] to raise the blade.

**NOTE:** Keep the blade lowered when digging to help stabilise the machine.

## TRACK FRAME EXPANSION

### Expanding And Retracting The Tracks

Figure 35

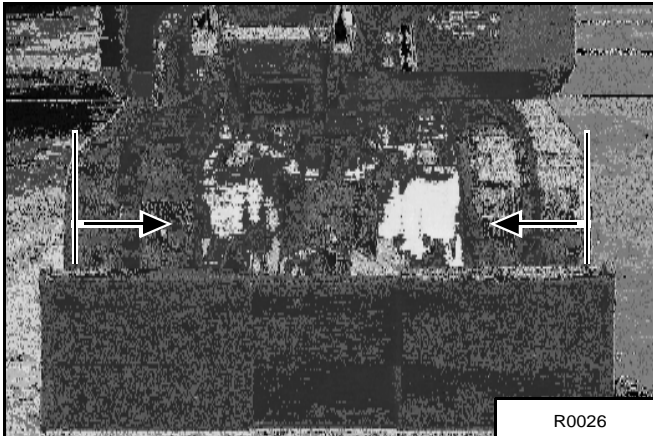

The excavator can be operated with the track frame retracted for transport on a trailer or to access narrow areas [Figure 35].

Figure 36



Expand the track frame [Figure 36] for increased digging performance.

# IMPORTANT

To prevent wear and damage to the track, always lift the excavator before expanding or retracting the track frame.

I-2193-0599

Figure 37

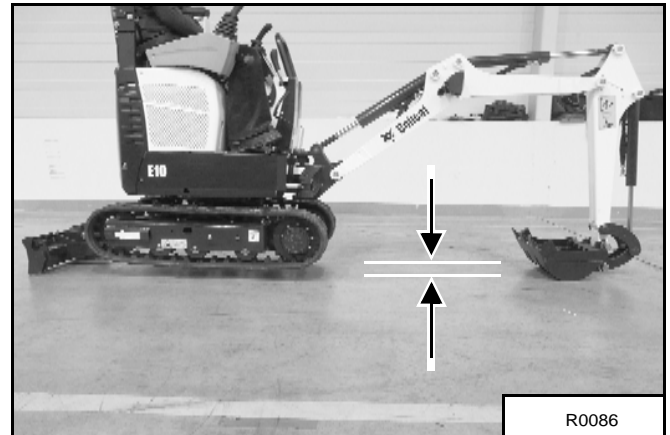

With the boom and arm positioned over the blade, lower the blade until the tracks are raised 25 to 50 mm off the ground [Figure 37].

Rotate the upper structure 180 degrees.

Lower the boom and arm to raise the rear of the excavator until the track is 25 to 50 mm off the ground [Figure 37].

Figure 38

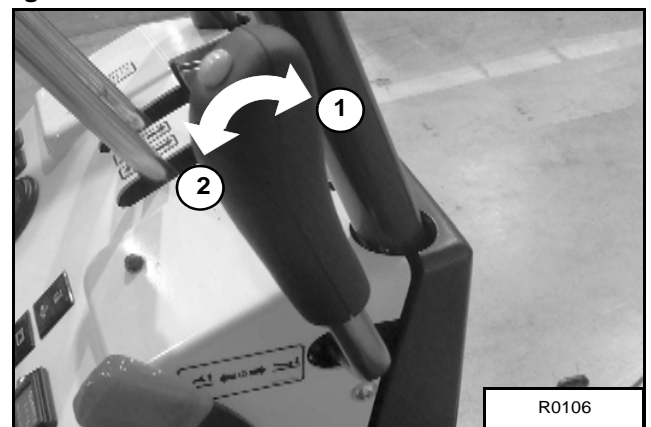

Raise the blade/track expansion lever (Item 1) [Figure 33] into the track position. Push the blade control/ track Expansion Lever forward (Item 1) [Figure 38] to expand the tracks; pull backward (Item 2) [Figure 38] to retract the tracks.

Lower the blade/track expansion lever (Item 1) [Figure 33] into the blade position.

**NOTE: Always operate the machine with the tracks expanded all the way or retracted all the way.**

Raise the boom and arm to lower the rear of the excavator to the ground.

Raise the blade all the way. Turn the upperstructure 180 degrees.

## UPPERSTRUCTURE SLEW LOCK

Figure 39

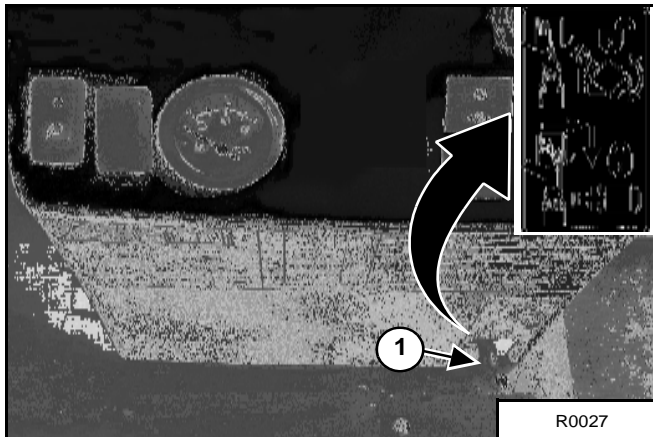

Move the slew lock pin (Item 1) [Figure 39] to the right and down to engage the upperstructure slew lock. Fit the pin properly to fully engage the slew lock. When the slew lock is engaged (locked), the upperstructure of the excavator is locked to the track frame and will not rotate.

**NOTE: The upperstructure must be in the straight forward or straight backward position for the upperstructure to lock.**

Move the slew lock pin (Item 1) [Figure 39] up and to the left to disengage the upperstructure from the track frame. Fit the lever properly to fully disengage the slew lock.

## **WARNING**

### **AVOID INJURY**

**The slew lock pin must be engaged when transporting the machine.**

W-2197-059

DAILY INSPECTION

Figure 40



Daily Inspection And Maintenance

Maintenance work must be done at regular intervals. Failure to do so will result in excessive wear and early failures. The Service Schedule [Figure 40] is a guide for correct maintenance of the Bobcat Excavator.

Check the following items before each day of operation:

- Operator Canopy (TOPS) and mounting hardware
- Seat belt and mounting hardware
- Damaged decals, replace as needed
- Check function of the control lockout levers
- Air cleaner system
- Engine coolant level and for coolant leaks
- Clean engine area of any flammable material
- Hydraulic fluid level and system for leaks
- Grease all pivot points
- Track tension
- Engine cover latch
- Repair broken and loose parts

**! WARNING**

Instructions are necessary before operating or servicing machine. Read and understand the Operation & Maintenance Manual, Operator's Handbook and signs (decals) on machine. Follow warnings and instructions in the manuals when making repairs, adjustments or servicing. Check for correct function after adjustments, repairs or service. Untrained operators and failure to follow instructions can cause injury or death.

W-2003-0903

Fluids such as engine oil, hydraulic fluid, coolants, etc., must be recycled or disposed of in an environmentally safe manner. Some regulations require that certain spills and leaks on the ground must be cleaned in a specific manner. See local, state, and federal regulations for correct disposal.

**PRE-STARTING PROCEDURE**

**Before Starting The Engine**

**Figure 41**

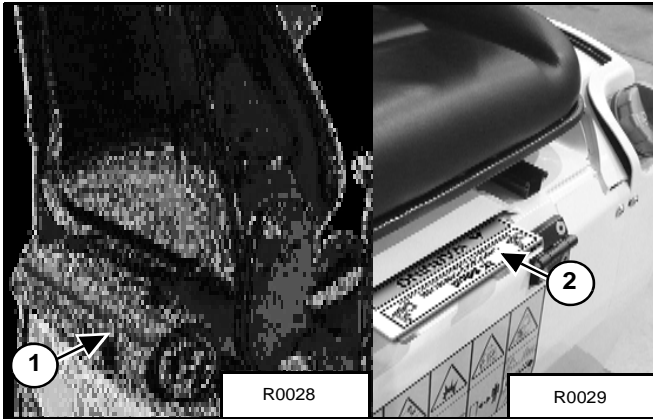

Read and understand the Operation & Maintenance Manual (Item 1) and the Operator's Handbook (Item 2) [Figure 41] before operating.

The Operation & Maintenance Manual and other manuals can be kept in a container (Item 1) [Figure 41] provided behind the operator's seat.

**NOTE: Make sure the engine cover is latched.**

Use the canopy, the tracks and safety treads to enter.

**Figure 42**



Release the seat lever (Item 1) [Figure 42] to adjust the seat forward or backward for comfortable operation.

**Figure 43**

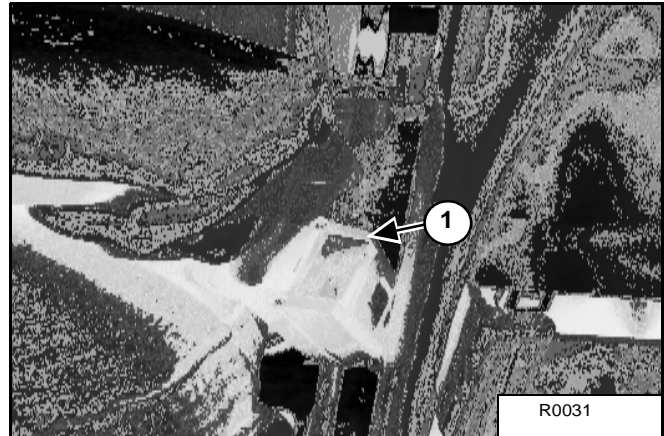

Fasten the seat belt (Item 1) [Figure 43].

**Figure 44**

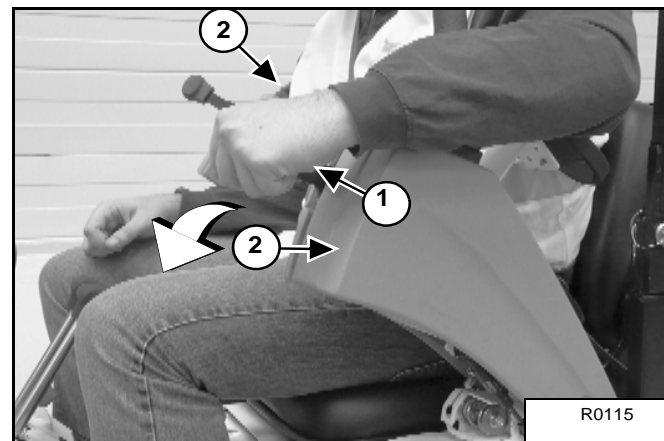

Lower both control lockout consoles (Item 2) using the control lockout levers (Item 1) [Figure 44].

**NOTE: The control lockout console must be in the down position for the hydraulic control levers to operate.**

### STARTING THE ENGINE

Perform the PRE-STARTING PROCEDURE. (See PRE-STARTING PROCEDURE on page 45).



#### AVOID INJURY OR DEATH

- Fasten seat belt, start and operate only from the operator seat.
- Never wear loose clothing when working near machine.

W-2135-1188

Figure 45

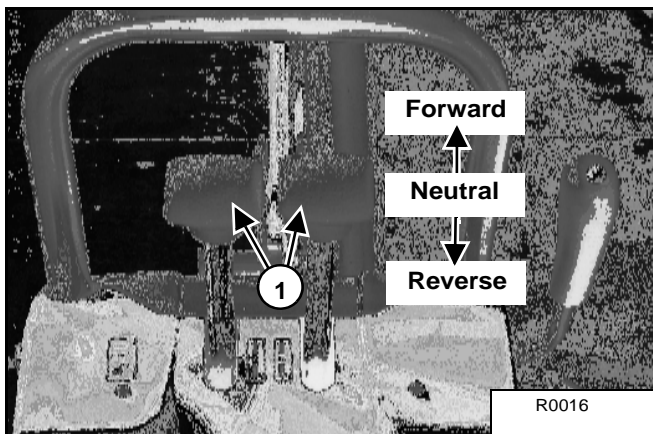

Put the steering levers (Item 1) [Figure 45] in the NEUTRAL position.

Figure 46

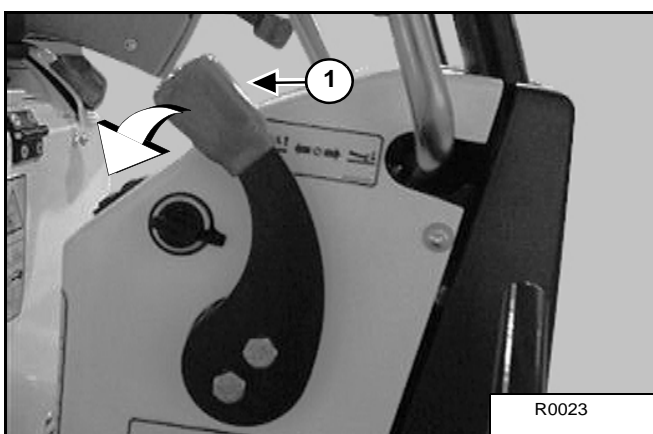

Move the engine speed control lever (Item 1) [Figure 46] to low idle.



When an engine is running in an enclosed area, fresh air must be added to avoid concentration of exhaust fumes. If the engine is stationary, vent the exhaust outside. Exhaust fumes contain odorless, invisible gases which can kill without warning.

W-2050-1285

Figure 47

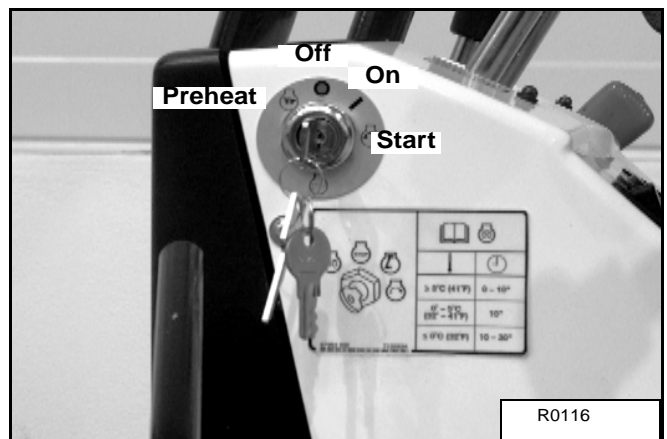

Turn the key to the PREHEAT position (if required). [Figure 47].

Turn the key to the START position [Figure 47] and release the key when the engine starts. It will return to the ON position.

Stop the engine if the warning lights and alarm do not go OFF. Check for the cause before starting the engine again.

Turn the key switch OFF to stop the engine.



Do not engage the starter for longer than 15 seconds at a time. Longer use can damage the starter by overheating. Allow starter to cool for one minute before using starter again.

I-2034-0700

**STARTING THE ENGINE (CONT'D)**

**Cold Temperature Starting Procedure**

If the temperature is below freezing, perform the following to make starting the engine easier:

Replace the engine oil with the correct type and viscosity for the anticipated starting temperature.

Make sure the battery is fully charged.

**NOTE: If the battery is discharged (but not frozen) a booster battery can be used to jump start the excavator. (See Using A Booster Battery (Jump Starting) on page 78).**

Install an engine heater.



**Do not use ether with glow plug (preheat) systems. Explosion can result which can cause injury, death, or severe engine damage.**

W-2071-0903

Figure 48

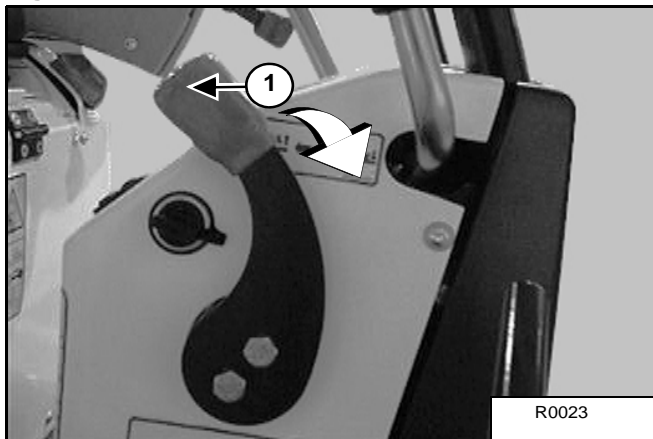

Push the engine speed control lever (Item 1) [Figure 48] fully forward.



**Do not engage the starter for longer than 15 seconds at a time. Longer use can damage the starter by overheating. Allow starter to cool for one minute before using starter again.**

I-2034-0700



**AVOID INJURY OR DEATH**

- Engines can have hot parts and hot exhaust gas. Keep flammable material away.
- Do not use machines in atmosphere containing explosive gas.

W-2051-1086

Figure 49

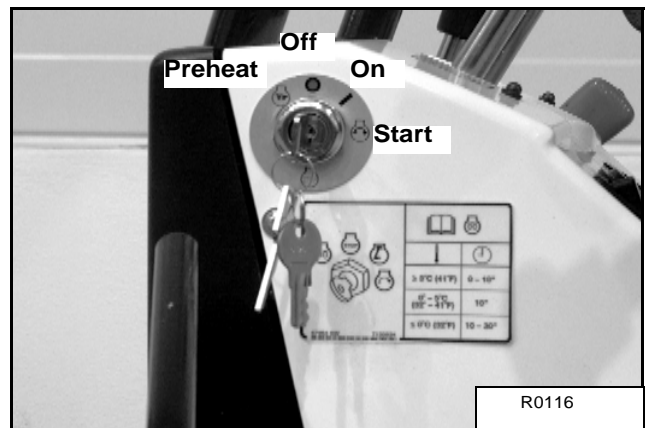
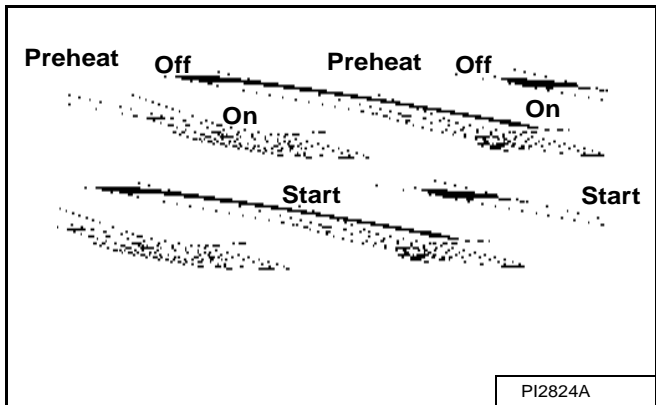

Figure 50



Turn the key to the PREHEAT position [Figure 49]. The light (Item 1) [Figure 49] will come ON. Preheat the engine for 15 seconds maximum.

Turn the key to the START position [Figure 49] and release the key when the engine starts. It will return to the ON position.

When the engine speed increases, move the engine speed control lever to the low idle position.

Turn the key switch OFF to stop the engine [Figure 49].

## BUCKETS AND ATTACHMENTS

### Installing

# ! WARNING

### AVOID INJURY OR DEATH

Stop the machine on a firm flat surface. When removing or installing attachments (such as a bucket), always have a second person in the operator's seat, give clear signals and work carefully.

W-2140-0189

Figure 51

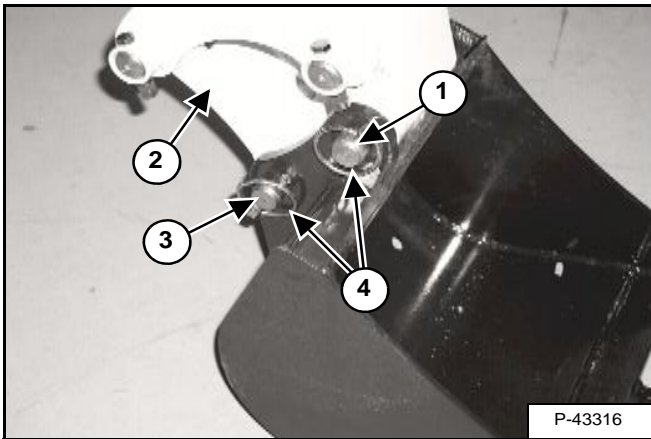

Install the link (Item 2) [Figure 51] into the bucket, align the hole, install the pivot pin and washer (Item 3) [Figure 51].

Install the arm into the bucket, align the hole, install the pivot pin (Item 1) [Figure 51].

Install the fasteners (Item 4) [Figure 51]. Add grease to the pivot pins before operation.

### Removing

Park the excavator on flat level ground and put the bucket on the ground.

Remove the fasteners and pivot pins (1, 3 & 4) [Figure 51]. Keep the pivot pins clean.

# ! WARNING

Never use attachments or buckets which are not approved by Bobcat Company. Buckets and attachments for safe loads of specified densities are approved for each model. Unapproved attachments can cause injury or death.

W-2052-0500



## OPERATING PROCEDURE

### Inspecting The Work Area

Before beginning operation, inspect the work area for unsafe conditions.

Look for sharp drop-offs or rough terrain. Have underground utility lines (gas, water, sewer, irrigation, etc.) located and marked.

Remove objects or other construction material that could damage the excavator or cause personal injury.

### Lowering The Work Equipment (Engine STOPPED)

The hydraulic control levers control the movement of the boom, arm, bucket and upperstructure slew functions.

Figure 52

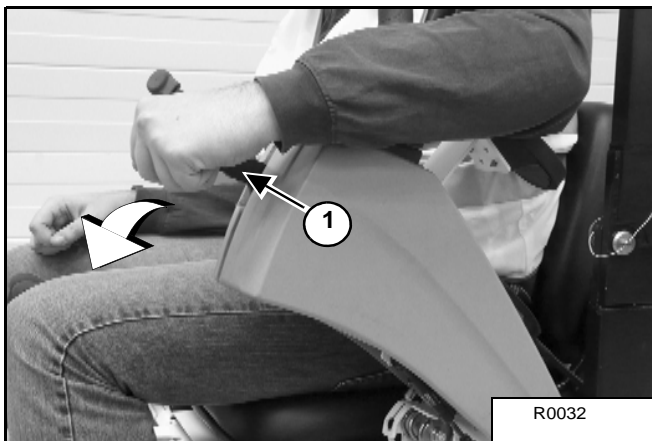

The control lockout lever (Item 1) disengages the hydraulic control functions from the joysticks when the console(s) are raised [Figure 52].

**NOTE: If the engine stops, the boom/bucket (attachments) can be lowered to the ground using hydraulic pressure in the accumulator. The control console(s) must be in the locked down position, and the key switch in the ON position. Use the control lever to lower the boom.**

Lower the control console(s) to engage the hydraulic control functions of the joysticks [Figure 52].

### Driving On Public Roads

When operating on a public road or motorway, always follow local regulations. For example: Slow Moving Vehicle Sign or direction signals can be required.

**NOTE: Road kits are available from your Bobcat dealer to equip your machine for driving on public roads in European Union (EU) countries.**

Always follow local regulations. For more information, contact your local Bobcat dealer.

## ! WARNING

### AVOID INJURY OR DEATH

**Do not exceed rated lift capacity. Excessive load can cause tipping or loss of control.**

W-2374-0500

Run the engine at low idle speed to warm up the engine and hydraulic system before operating the excavator.

Steel tracks are not allowed on public roads. Plastic pads should be added on steel tracks to be allowed to travel on public roads.

## IMPORTANT

**Machines warmed up with moderate engine speed and light load have longer life.**

I-2015-0284

**OPERATING PROCEDURE (CONT'D)**

**Excavating**

Lower the blade to provide stability.

Expand the tracks for increased excavating performance.

**Figure 53**

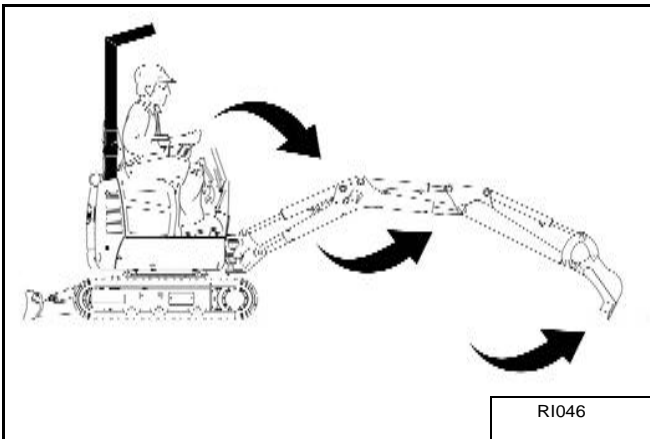

Extend the arm, lower the boom, and open the bucket [Figure 53].

**Figure 54**

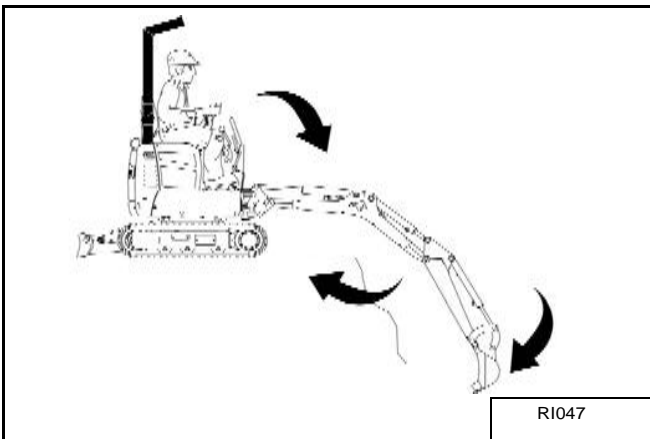

Retract the arm, while lowering boom and curling the bucket [Figure 54].

**Figure 55**

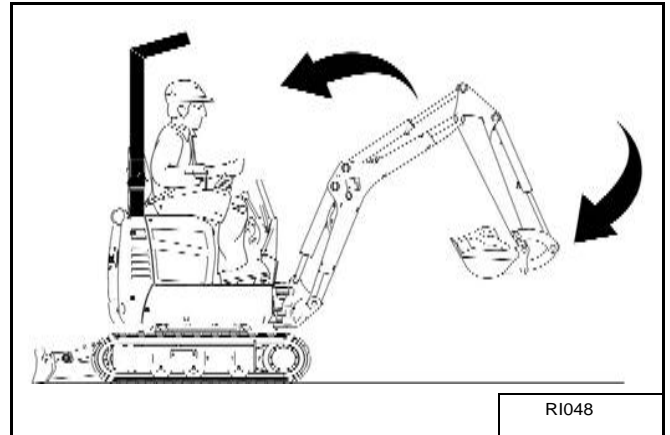

Raise the boom, retract the arm and curl the bucket [Figure 55].

Rotate the upperstructure. (See STEERING LEVERS on page 36).

**NOTE:** Do not allow the bucket teeth to make contact with the ground when slewing the upperstructure.

**! WARNING**

Keep all bystanders 20 feet (6 m) away from equipment when operating. Contact with moving parts, a trench cave-in or flying objects can cause injury or death.

W-2119-0788

**OPERATING PROCEDURE (CONT'D)**

**Excavating (Cont'd)**

**Figure 56**

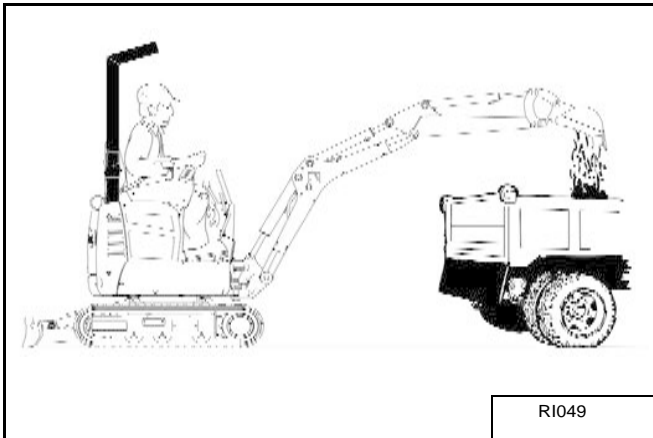

Extend the arm and uncurl the bucket to dump the material into a pile or truck [Figure 56].

**Figure 57**

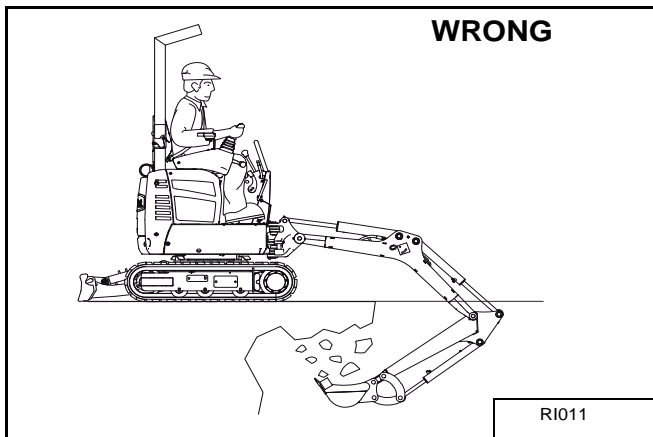

Do not dig under the excavator [Figure 57].

Do not use the bucket as a breaker or pile driver. It is better to excavate hard or rocky ground after breaking it with other equipment. This will reduce damage to the excavator.

Do not move the excavator while the bucket is in the ground.

**Boom Swing**

**Figure 58**

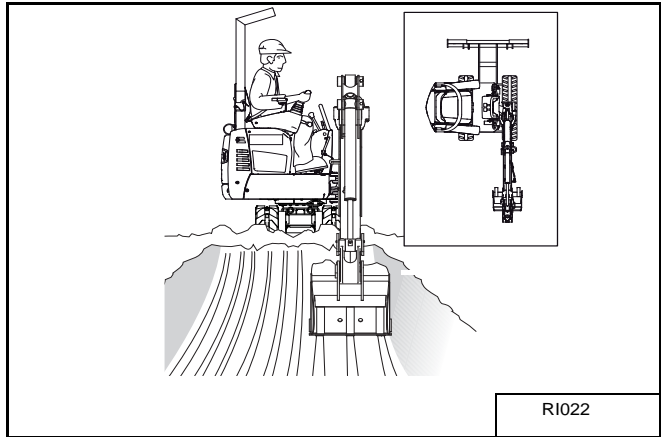

**Figure 59**

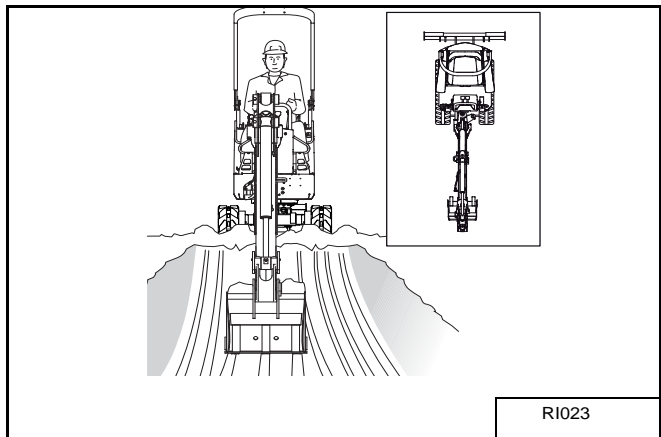

**Figure 60**

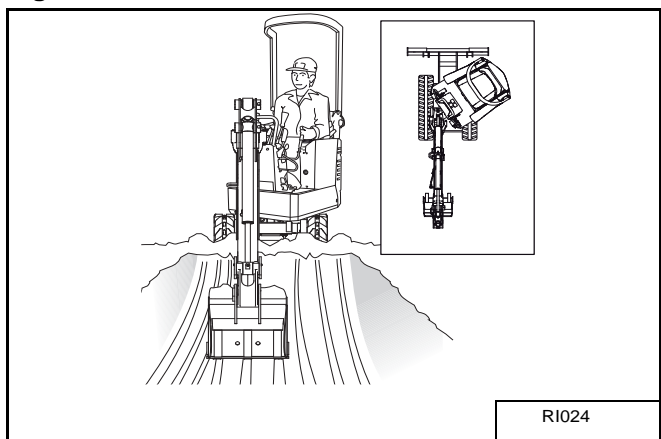

Slew the upperstructure, offset the boom to the left [Figure 58], centre [Figure 59] and right [Figure 60] to dig a square hole the width of the machine without repositioning the excavator.

## OPERATING PROCEDURE (CONT'D)

### Boom Swing (Cont'd)

Figure 61

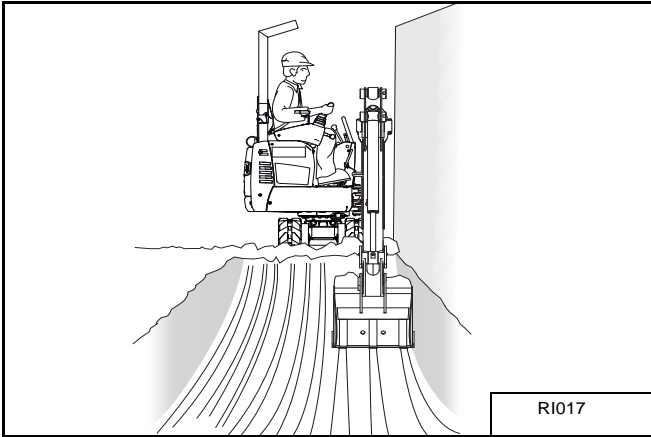

The boom offset allows the operator to dig close to buildings and other structures [Figure 61].

### Backfilling

Figure 62

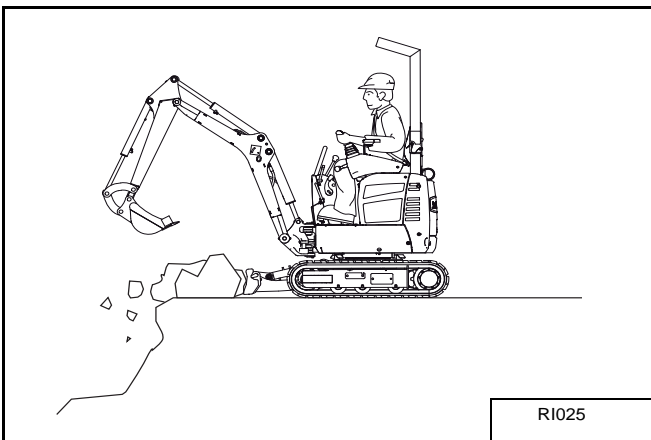

Use the blade to backfill the trench or hole after excavating [Figure 62].

### Driving The Excavator

When operating on uneven ground, operate as slowly as possible and avoid sudden changes in direction.

Avoid driving over objects such as rocks, trees, stumps, etc.

When working on wet or soft ground, put planks on the ground to provide a solid base to drive on and prevent the excavator from getting stuck.

Figure 63

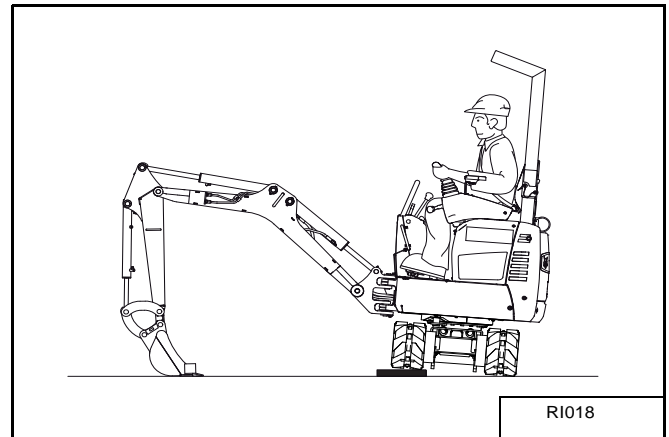

If one or both tracks have become stuck in soft or wet ground, raise one track at a time by turning the upperstructure and pushing the bucket against the ground [Figure 63].

Put planks under the tracks and drive the excavator to dry ground.

Figure 64

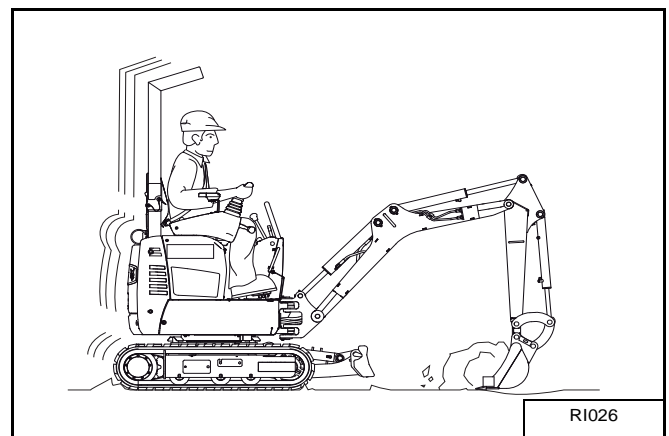

The bucket can also be used to pull the excavator. Raise the blade, extend the arm and lower the boom. Operate the boom and arm in a digging manner [Figure 64].

OPERATING PROCEDURE (CONT'D)

Operating On Slopes

**! WARNING**

**AVOID INJURY OR DEATH**

- Do not travel across or up slopes that are over 15 degrees.
- Do not travel down or back up slopes that exceed 25 degrees.
- Look in the direction of travel.

W-2497-0304

When going down a slope, control the speed with the steering levers and the engine speed control lever.

Figure 65

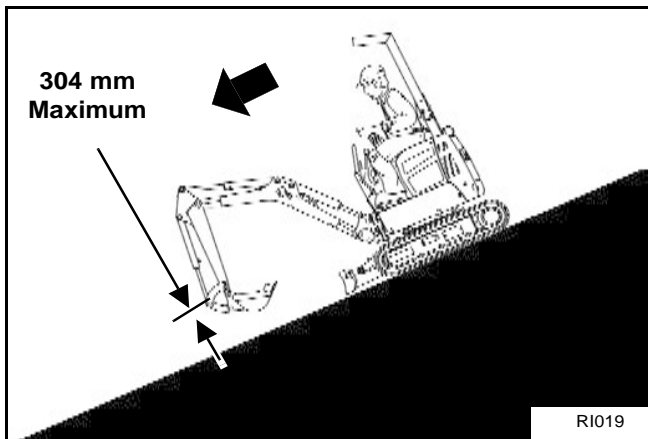

When going down or backing up grades that exceed 15 degrees, put the machine in the position shown, and run the engine slowly [Figure 65].

Operate as slowly as possible and avoid sudden changes in lever direction.

Avoid driving over objects such as rocks, trees, stumps, etc.

Stop the machine before moving the upper equipment controls. Never allow the blade to strike a solid object. Damage to the blade or hydraulic cylinder can result.

**! WARNING**

**AVOID INJURY OR DEATH**

- Avoid steep areas or banks that could break away.
- Keep boom centred and attachments as low as possible when travelling on slopes or in rough conditions. Look in the direction of travel.
- Always fasten seat belt.

W-2498-0304

Figure 66

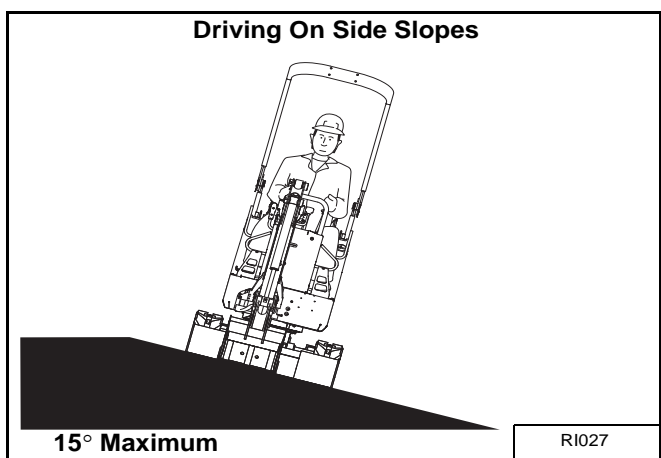
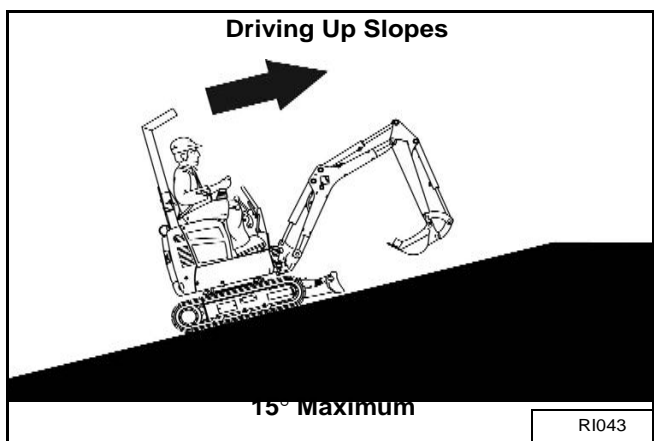

Figure 67



When going up slopes or on side slopes that are 15 degrees or less, position the machine as shown and run the engine slow [Figure 66] & [Figure 67].

OPERATING PROCEDURE (CONT'D)

Operating On Slopes (Cont'd)

Figure 68

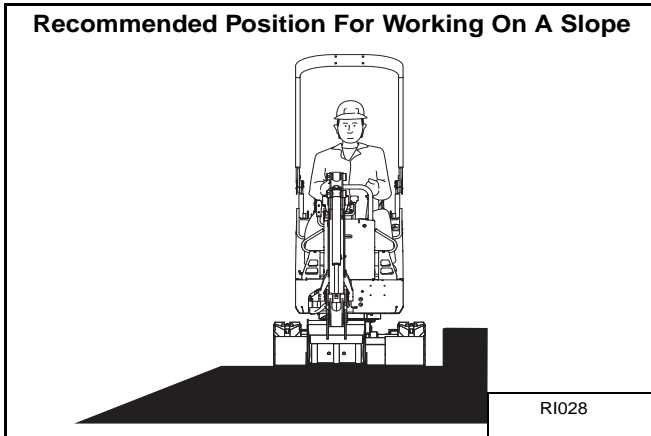

When operating on a slope, level the work area before beginning [Figure 68].

If this is not possible, the following procedures should be used:

Do not work on slopes which are over 15 degrees.

Use a slow work cycle.

Avoid working with the tracks across the slope. This will reduce stability and increase the tendency for the machine to slide. Position the excavator with the blade downhill and lowered.

Avoid swinging or extending the bucket more than necessary in a down hill direction. When you must swing the bucket downhill, keep the arm low and skid the bucket downhill.

When working with the bucket on the uphill side, keep the bucket as close to the ground as possible. Dump the spoil far enough away from the trench or hole to prevent the possibility of a cave-in.

Figure 69

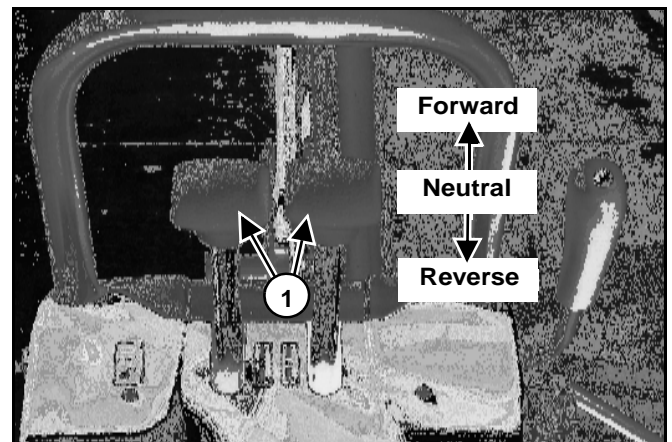

To brake the machine when going down a slope, move the steering levers (Item 1) [Figure 69] to the NEUTRAL position. This will engage the hydrostatic braking.

When the engine stops on a slope, move the steering levers to the neutral position. Lower the boom/bucket to the ground.

**NOTE: If the engine stops, the boom/bucket (attachments) can be lowered to the ground using hydraulic pressure in the accumulator. The console must be in the locked down position, and the key switch in the ON position. Use the control lever to lower the boom.**

Start the engine and resume operation.

**OPERATING PROCEDURE (CONT'D)**

**Operating In Water**

Mud and water should be removed from the machine before parking. In freezing temperatures, park the machine on boards or concrete to prevent the track or undercarriage from freezing to the ground and preventing machine movement.

**Figure 70**

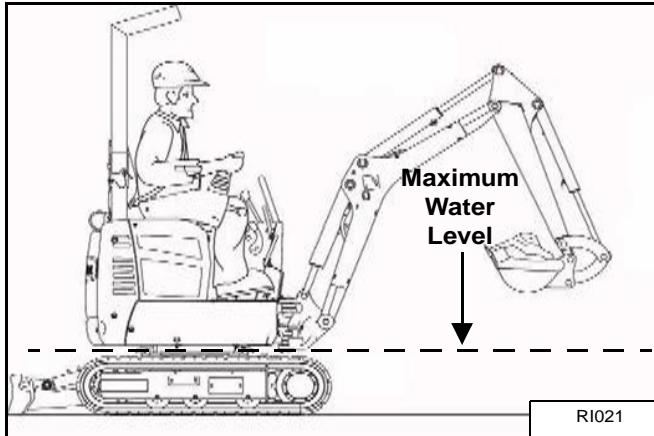

Do not operate or immerse the excavator in water higher than the bottom of the swing bearing [Figure 70].

Grease the excavator when it has been operated or immersed in water for a period of time. Greasing forces the water out of the lubrication areas.

Water must be removed from the cylinder rods. If water freezes to the cylinder rod, the cylinder seals can be damaged when the rod is retracted.

**Avoiding Track Damage**

**Figure 71**

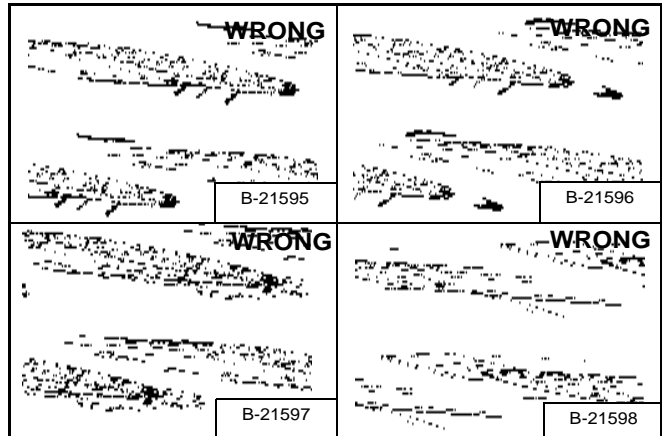

- Do not travel or turn on a sharp edge or stepped grade.
- The illustration [Figure 71] shows operating conditions to avoid to prevent damage to the rubber tracks.
- Do not turn sharply on a surface with a high-friction factor such as concrete or asphalt.
- Keep oil off the track. Clean any oil spills.
- Do not operate on a beach or in an area which can cause excessive corrosion.
- If the machine is not used for a long period of time, keep it indoors to prevent direct exposure to sunlight, rain, snow, etc.

## PARKING THE EXCAVATOR

Figure 72

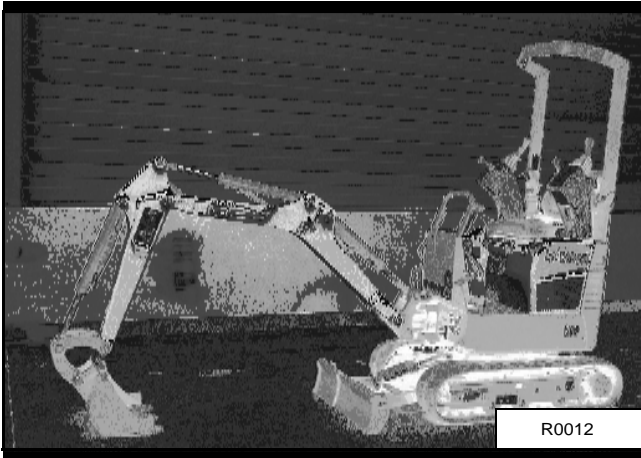

Stop the machine on level ground. Lower the work equipment and the blade to the ground [Figure 72].

Figure 73

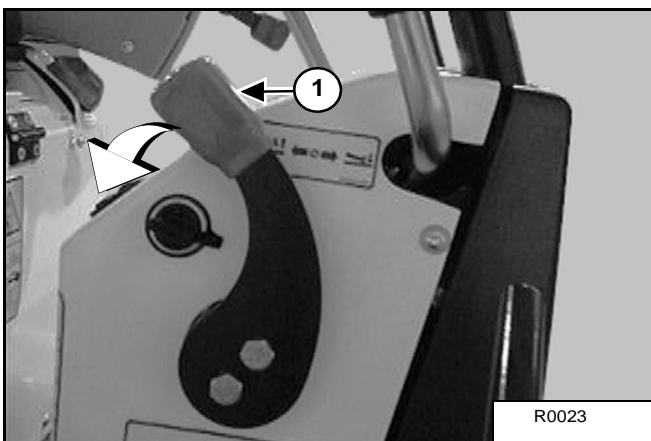

Move the engine speed control lever (Item 1) fully down [Figure 73] and run the engine at idle speed for about 5 minutes to allow it to cool.

Stop the engine.

Raise the control lockout levers.

Disconnect the seat belt. Remove the key from the switch to prevent operation of machine by unauthorised personnel. Exit machine.

## LIFTING THE EXCAVATOR

Fully extend the cylinders of the bucket, arm and boom.

Raise the blade all the way.

Turn the upper structure so that the boom is at the opposite end as the blade.

Put all the controls in neutral and engage the swing lock. See "UPPERSTRUCTURE SLEW LOCK" on page 43.

## WARNING

### AVOID INJURY OR DEATH

- Use a lifting fixture with sufficient capacity for the weight of the excavator plus any added attachments.
- Maintain centre of gravity and balance when lifting.
- Do not swing boom or upperstructure. Engage the swing locking lever.
- Never lift with operator on machine.

W-2202-0595

Figure 74

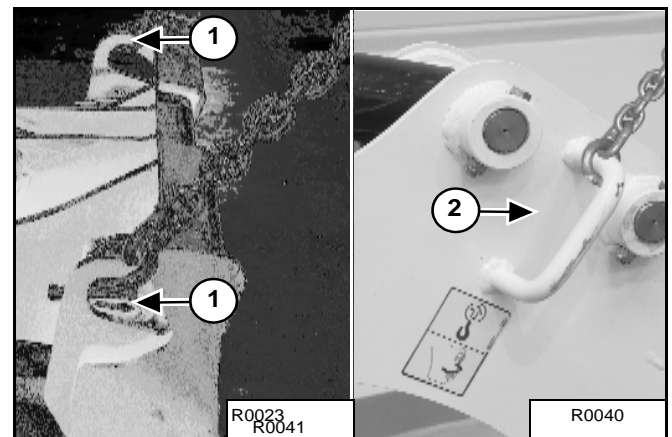

Fasten the chains to the ends of the blade (Item 1) [Figure 74] and up to a lifting fixture above the canopy.

Fasten a chain in the hook of the boom (Item 2) [Figure 74].





## TRANSPORTING THE EXCAVATOR

### Loading Onto Transport Vehicle

When transporting the machine, observe the rules, motor vehicle laws and vehicle limit ordinances. Use a transport and towing vehicle of adequate length and capacity.

Secure the brakes and block the wheels of the transport vehicle.

Align the ramps with the centre of the transport vehicle. Secure the ramps to the truck (or trailer) bed and be sure ramp angle does not exceed 15 degrees.

Use metal loading ramps with a slip resistant surface.

Use ramps that are the correct length and width, and can support the weight of the machine.

The rear of the trailer must be blocked to be supported when loading or unloading to prevent the front of the transport from raising.

Determine the direction of the track movement before moving the machine (blade forward). Engage the swing lock. (See UPPERSTRUCTURE SLEW LOCK on page 43).

**Figure 75**

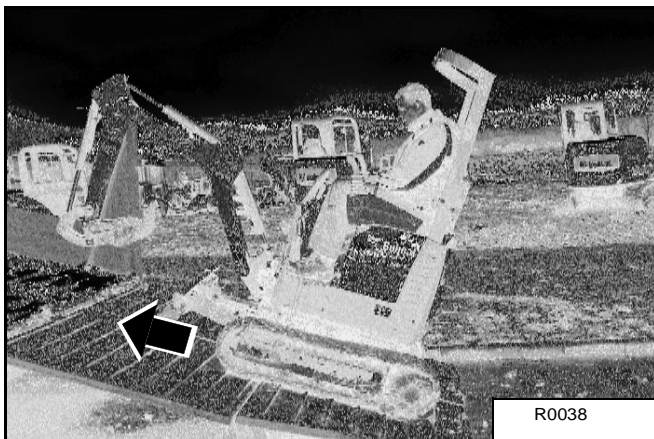

Move the machine forward onto the transport vehicle **[Figure 75]**.

Do not change direction of the machine while it is on the ramps.

Lower the boom, arm, bucket and blade to the transport vehicle.

Stop the engine and remove the key.

Put blocks under the front and rear of the track shoes.

TRANSPORTING THE EXCAVATOR (CONT'D)

Fastening To Transport Vehicle

Figure 76

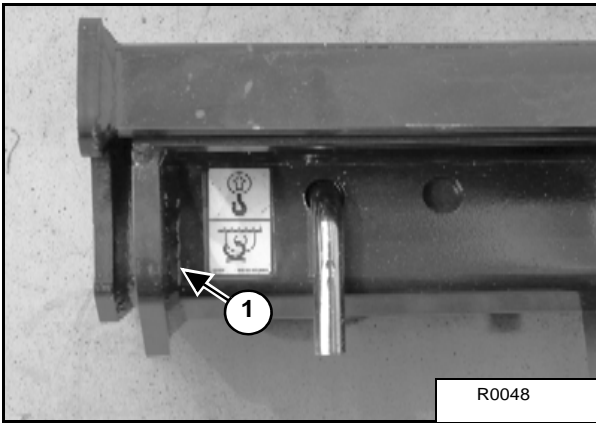
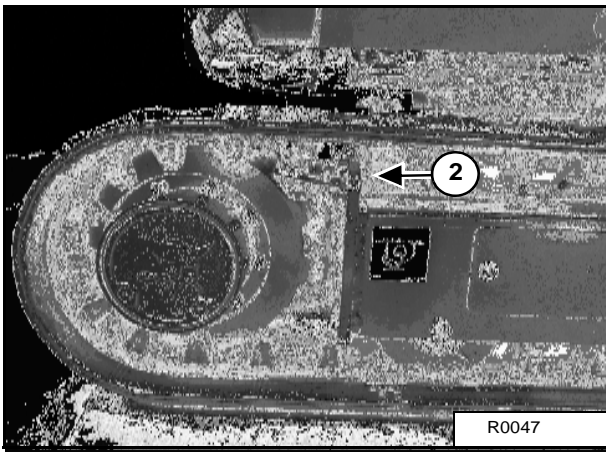
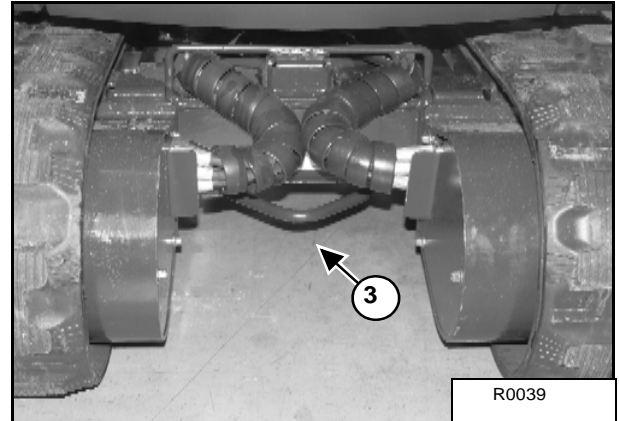

Figure 77



Fasten chains to the front corners of the blade (Item 1) [Figure 76], to both sides of the tracks (Item 2) [Figure 77] and to the tie down loop at the rear of the track frame (Item 3) [Figure 78].

Figure 78



Use chain binders to tighten the chains and then safety tie the chain binder levers to prevent loosening.

Figure 79

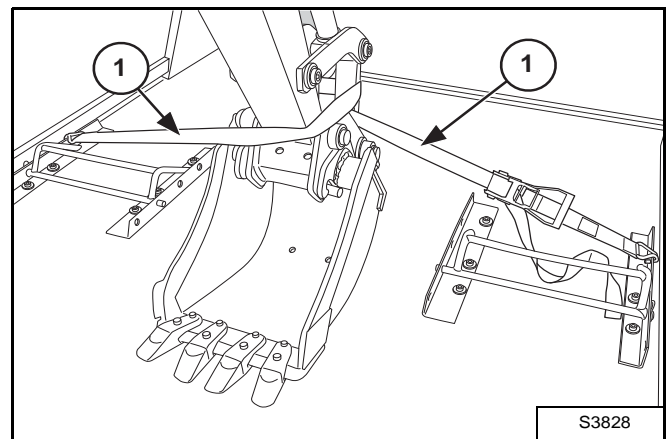

- When on the transport vehicle, loop the chains through the holes in the mounting frame.
- Loop the chain (Item 1) [Figure 79] around the bucket link.

**WARNING**

Adequately designed ramps of sufficient strength are needed to support the weight of the machine when loading onto a transport vehicle. Wood ramps can break and cause personal injury.

W-2058-0494

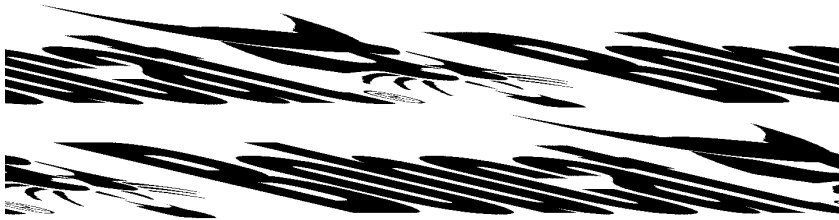



**PREVENTIVE MAINTENANCE**

SERVICE SCHEDULE .....	64
Chart .....	64
TAILGATE .....	66
Opening and Closing the Tailgate .....	66
AIR CLEANER .....	67
Daily Check .....	67
Replacing The Filters .....	67
SEAT BELT .....	68
Inspection And Maintenance .....	68
FUEL SYSTEM .....	69
Fuel Specifications .....	69
Filling The Fuel Tank .....	69
Removing Water From The Fuel Filter .....	69
Replacing The Fuel Filter .....	69
Draining The Fuel Tank .....	69
Removing Air From The Fuel System .....	70
ENGINE LUBRICATION SYSTEM .....	70
Checking Engine Oil .....	70
Replacing Oil And Filter .....	71
COOLING SYSTEM .....	72
Cleaning The Cooling System .....	72
Checking The Coolant Level .....	72
Replacing The Coolant .....	73
ALTERNATOR BELT .....	74
Adjusting The Alternator Belt .....	74
ELECTRICAL SYSTEM .....	76
Description .....	76
Fuses .....	76
Relays And Diodes .....	76
Servicing The Electrical System And Battery .....	77
Using A Booster Battery (Jump Starting) .....	78
Removing And Installing The Battery .....	79
HYDRAULIC SYSTEM .....	80
Checking And Adding Hydraulic Oil .....	80
Replacing The Hydraulic Filter .....	80
Draining Hydraulic Oil .....	81
Diagnostic Connectors .....	82
CONTROL CONSOLE LOCKOUTS .....	83
Inspection And Maintenance .....	83
SPARK ARRESTER MUFFLER .....	84
Cleaning Procedure .....	84



TRACK TENSION . . . . .	85
Adjusting . . . . .	85
DRIVE MOTOR . . . . .	87
Checking Oil Level . . . . .	87
Draining The Drive Motor . . . . .	87
BLADE EXTENSION . . . . .	88
Description . . . . .	88
Extending And Retracting . . . . .	88
TRACK ROLLER AND IDLER LUBRICATION . . . . .	89
Procedure . . . . .	89
LUBRICATING THE EXCAVATOR . . . . .	89
Blade . . . . .	89
Boom Swing And Boom Base . . . . .	90
Boom, Middle . . . . .	90
Boom And Arm . . . . .	91
Frame Fittings . . . . .	92
Track Expansion Tube . . . . .	92
EXCAVATOR STORAGE AND RETURN TO SERVICE . . . . .	93
Storage . . . . .	93
Return To Service . . . . .	93

## MAINTENANCE SAFETY

### ! WARNING

Training is necessary before operating or servicing machine. Read and understand the Operation and Maintenance Manual, Operator's Handbook and signs (stickers) on machine. Follow warnings and instructions in the manuals when making repairs, adjustments or servicing. Check for correct function after adjustments, repairs or service. Untrained operators and failure to follow instructions can cause injury or death.  
W-2003-0807



**Safety Alert Symbol:** This symbol with a warning statement, means: "Warning, be alert! Your safety is involved!" Carefully read the message that follows.

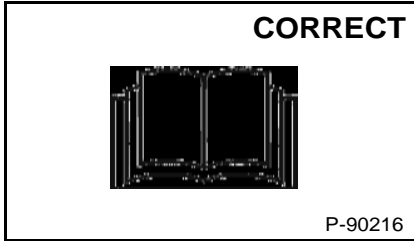

! Never service the Bobcat Compact Excavator without instructions.

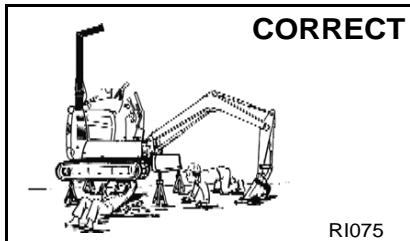

! Use the correct procedure to lift and support the excavator.

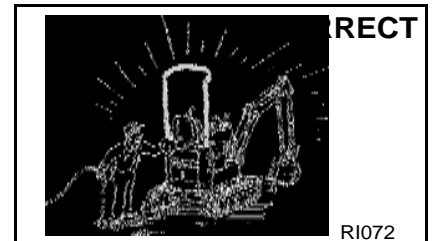

! Cleaning and maintenance are required daily.

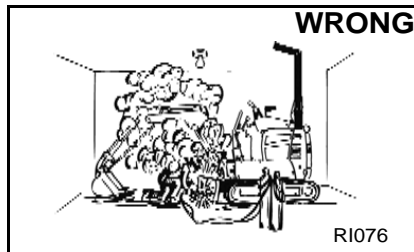

! Have good ventilation when welding or grinding painted parts.  
! Wear dust mask when grinding painted parts. Toxic dust and gas can be produced.

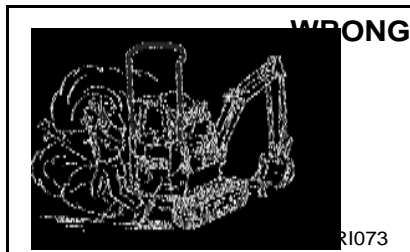

! Vent exhaust to outside when engine must be run for service.  
! Exhaust system must be tightly sealed. Exhaust fumes can kill without warning.

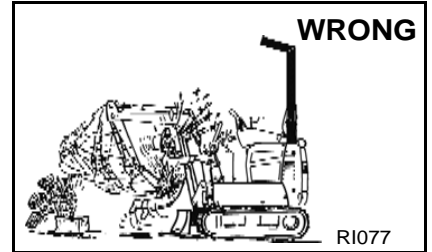

! Always lower the bucket and blade to the ground before doing any maintenance.  
! Never modify equipment or add attachments not approved by Bobcat Company.

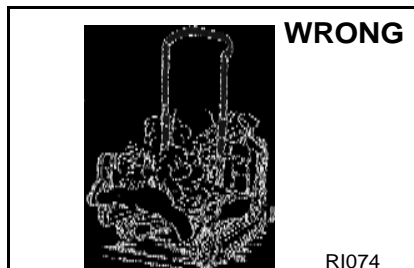

! Stop, cool and clean engine of flammable materials before checking fluids.  
! Never service or adjust machine with the engine running unless instructed to do so in the manual.  
! Avoid contact with leaking hydraulic fluid or diesel fuel under pressure. It can penetrate the skin or eyes.  
! Never fill fuel tank with engine running, while smoking, or when near open flame.

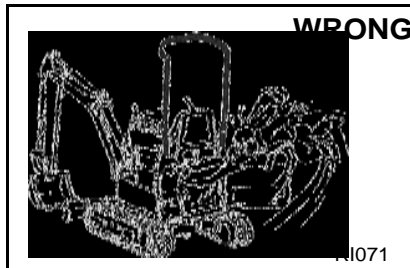

! Keep body, jewellery and clothing away from moving parts, electrical contact, hot parts and exhaust.  
! Wear eye protection to guard from battery acid, compressed springs, fluids under pressure and flying debris when engines are running or tools are used. Use eye protections approved for type of welding.  
! Keep tailgate closed except for service. Close and latch tailgate before operating the excavator.

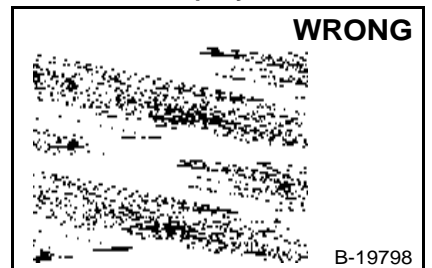

! Lead-acid batteries produce flammable and explosive gases.  
! Keep arcs, sparks, flames and lighted tobacco away from batteries.  
! Batteries contain acid which burns eyes or skin on contact.  
! Wear protective clothing. If acid contacts body, flush well with water. For eye contact flush well and get immediate medical attention.

Maintenance procedures which are given in the Operation and Maintenance Manual can be performed by the owner/operator without any specific technical training. Maintenance procedures which are **not** in the Operation and Maintenance Manual must be performed **ONLY BY QUALIFIED BOBCAT SERVICE PERSONNEL**. Always use **genuine Bobcat replacement parts**.



**Bobcat®**



**SERVICE SCHEDULE**

**Chart**

Maintenance work must be done at regular intervals. Failure to do so will result in excessive wear and early failures. The service schedule is a guide for correct maintenance of the Bobcat Excavator.



**Instructions are necessary before operating or servicing machine. Read and understand the Operation & Maintenance Manual, Operator's Handbook and signs (decals) on machine. Follow warnings and instructions in the manuals when making repairs, adjustments or servicing. Check for correct function after adjustments, repairs or service. Untrained operators and failure to follow instructions can cause injury or death.**

W-2003-0903

SERVICE SCHEDULE		HOURS					
ITEM	SERVICE REQUIRED	8-10	50	100	250	500	[3] 1000
Engine Coolant	Check coolant level. Add premixed coolant as needed.						
Engine Oil	Check the engine oil level and add as needed.						
Hydraulic Fluid, Hoses and Tubelines	Check the hydraulic fluid level and add as needed. Check for damage and leaks. Repair or replace as needed.						
Engine Air Filter and Air System	Check condition indicator and empty dust cup as needed. Check air system for leaks.						
Tracks	Check and adjust track tension as needed.						
Indicators and Lights	Check for correct operation of all indicators and lights.						
Control Console Lockout	Check for proper function. Repair or replace as needed.						
Operator Canopy	Check condition. Check mounting hardware.						
Seat Belt	Check condition. Check mounting hardware.						
Safety Signs and Safety Treads	Check for damaged signs (stickers) and safety treads. Replace any signs or safety treads that are damaged or worn.						
Pivot Points	Grease all machinery pivot points.						
Swing Circle and Pinion	Grease two fittings.						
Fuel Tank and Filter	Drain water and sediment from fuel tank and fuel filter.						
Battery	Check battery, cables, connections and electrolyte level. Add distilled water as needed.						
Alternator / Fan Belt	Check condition of belt and adjust as needed.		[1]				
Spark Arrester muffler	Clean the spark chamber.						
Fuel Filter	Replace fuel filter.						
Drive Motor	Check lubricant level in both drive motors.			[2]			
Engine Oil and Filter	Replace oil and filter. Use CD or better grade oil and Bobcat filter.		[1]				
Radiator, and Oil Cooler	Clean debris from the radiator fins.						
Hydraulic Filter	Replace the filter.			[2]			
Alternator & Starter	Check the alternator and starter connections.			[2]			
Engine Valves	Check and adjust the engine valve clearance.						
Drive Motor	Replace lubricant in both drive motors.						
Hydraulic System	Replace the hydraulic fluid and filters. Clean the reservoir.			[2]			
Engine Cooling System	Drain and flush the cooling system. Replace premixed coolant every 2 years.						

[1] Also at first 50 hours.

[2] Also at first 100 hours.

[3] Or every 12 months.

The Inspection Checkbook (logbook) can be ordered for you by your local dealer. Part number: 4420310.





## SERVICE SCHEDULE (CONT'D)

### Contents Of The Inspection Checkbook (Logbook)

Maintenance work must be done at regular intervals. Failure to do so will result in excessive wear and early failures. The service schedule is a guide for correct maintenance of the Bobcat Excavator.

The Inspection Checkbook contains the following information:

- Doosan Trading Limited Warranty Conditions
- Protection Plus Extended Warranty Conditions
- General Parts Policy
- General Information
- First Inspection
- Scheduled Services
- Authorised Identification
- Lubricants and Fluids Table
- Service Parts Charts

Your local dealer can order the Inspection Checkbook. Part number: 4420310.

## TAILGATE

### Opening and Closing the Tailgate



#### AVOID INJURY OR DEATH

Never service or adjust the machine when the engine is running unless instructed to do so in the manual.

W-2012-0497

Figure 80

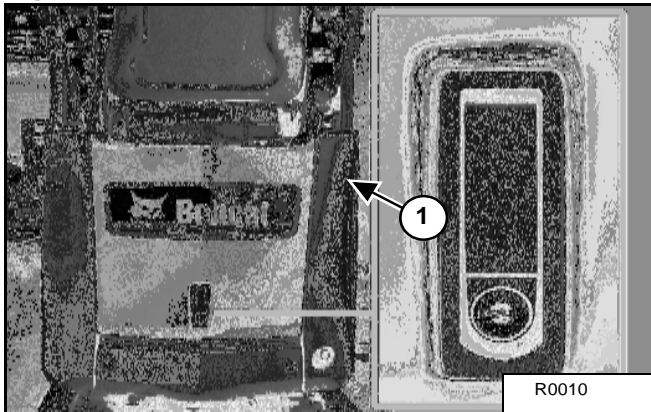

Release the latch (Item 1) [Figure 80] and pull the tailgate open.

Figure 81

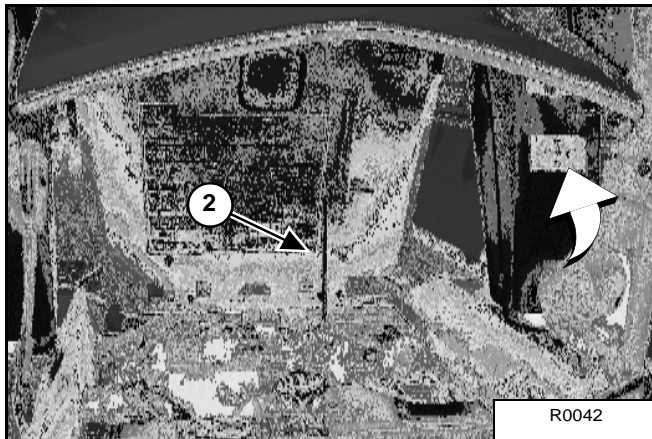

Pull the tailgate (Item 1) till blocking the wedge (Item 2) [Figure 81].

To close the tailgate, carefully pull the wedge, handling the tailgate, and then close it until the latch is closed again.

**NOTE:** The tailgate can be locked using the start key.

## AIR CLEANER

(See SERVICE SCHEDULE on Page 64.) for the correct service interval.

### Daily Check

Figure 82

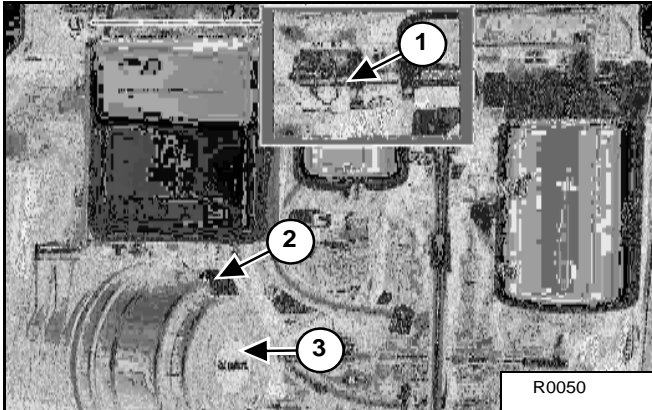

Check the condition indicator (Item 1) [Figure 82]. If the red ring shows in the condition indicator, the filter needs to be replaced.

### Replacing The Filters

#### Outer Filter

Pull out the locking tab (Item 2) [Figure 82].

Turn the dust cup (Item 3) [Figure 82] counter-clockwise about 1/8 turn.

Remove and clean the dust cup.

Figure 83

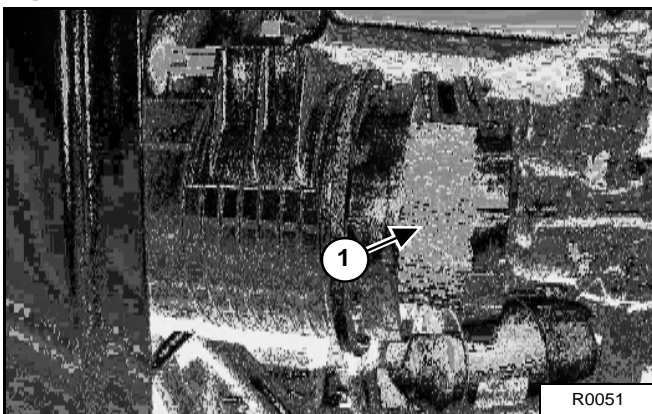

Pull the outer filter (Item 1) [Figure 83] from the air cleaner housing.

Check the housing for damage.

Clean the housing and the seal surface. DO NOT use compressed air.

Install a new outer filter.

Install the dust cup (Item 3) [Figure 82] and turn it clockwise about 1/8 turn.

Push the locking tab in (Item 2) [Figure 82].

Check the air intake hose and the air cleaner housing for damage. Make sure all connections are tight.

#### Inner Filter

Only replace the inner filter under the following conditions:

- Replace the inner filter every third time the outer filter is replaced.
- After the outer filter has been replaced, press the button on the top of the condition indicator (Item 1) [Figure 82] and start the engine. Run at full RPM, then reduce engine speed and stop the engine. If the red ring shows in the condition indicator, replace the inner filter.

Figure 84

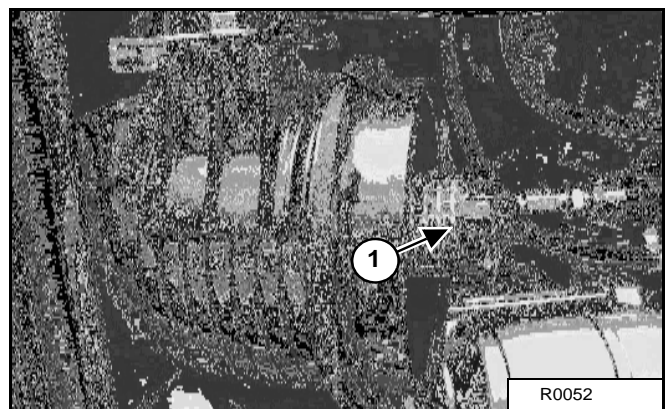

Remove the dust cup (Item 3) [Figure 82], the outer filter (Item 1) [Figure 83] and the inner filter (Item 1) [Figure 84].

**NOTE: Make sure all sealing surfaces are free of dirt and debris.**

Install the new inner filter.

Install the outer filter and the dust cup.

Press the button on the condition indicator to reset the condition indicator (Item 1) [Figure 82] (the red ring will not show anymore).

## SEAT BELT

### Inspection And Maintenance

# ! WARNING

Failure to properly inspect and maintain the seat belt can cause lack of operator restraint resulting in serious injury or death.

W-2466-0703

#### Check the seat belt daily for correct function.

Inspect the seat belt system thoroughly yearly or more often if the machine is exposed to severe environmental conditions or applications.

The seat belt system should be repaired or replaced if it shows cuts, fraying, extreme or unusual wear, significant discolourations due to ultraviolet (UV) rays from the sun, dusty/dirty conditions, abrasion to the seat belt webbing, or damage to the buckle, latch plate, retractor (if equipped), or hardware.

Figure 85

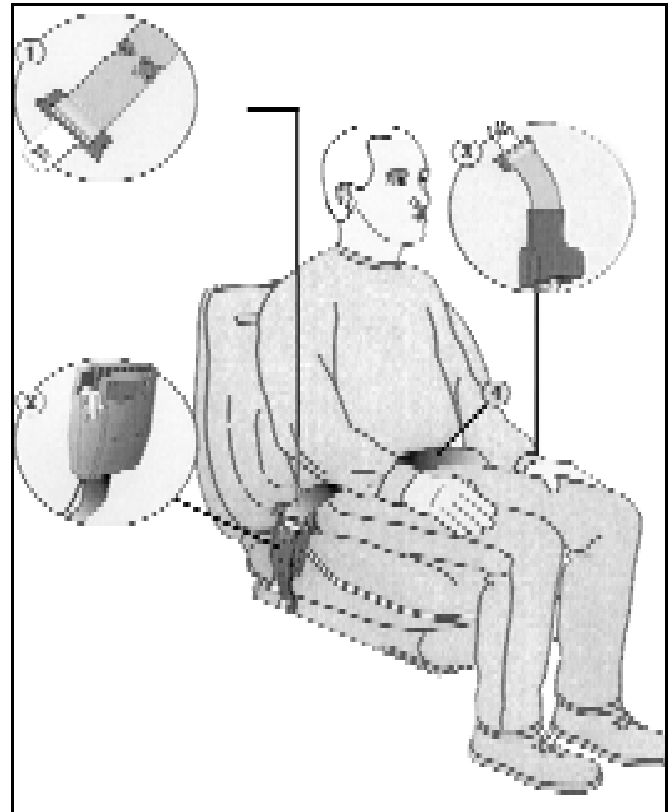

The items below are referenced in [Figure 85].

1. Check the seat belt webbing. If the system is equipped with a retractor, pull the webbing completely out and inspect the full length of the webbing. Look for cuts, wear, fraying, dirt and stiffness.
2. Check the buckle and latch for proper function. Make sure latch plate is not excessively worn, deformed or buckle is not damaged.
3. Check the retractor web storage device (if equipped) by extending the seat belt webbing to determine if it extends and retracts the webbing correctly.
4. Check webbing in areas exposed to ultraviolet (UV) rays from the sun or extreme dust or dirt. If the original colour of the webbing in these areas is extremely faded and / or the webbing is packed with dirt, the webbing strength can have weakened.

See your Bobcat dealer for approved seat belt system replacement parts for your machine.

**FUEL SYSTEM**

**Fuel Specifications**

Use only clean, high quality diesel fuel, Grade No. 2 or Grade No. 1.

The following is a suggested blending guideline which should prevent fuel gelling problems during freezing temperature.

Temp. °C	No. 2	No. 1
-9°	100%	0%
Down to -29°	50%	50%
Below -29°	0%	100%

See your fuel supplier for local recommendations.



**Stop and cool the engine before adding fuel. NO SMOKING!** Failure to obey warnings can cause an explosion or fire.

W-2063-0887

**Filling The Fuel Tank**

**Figure 86**

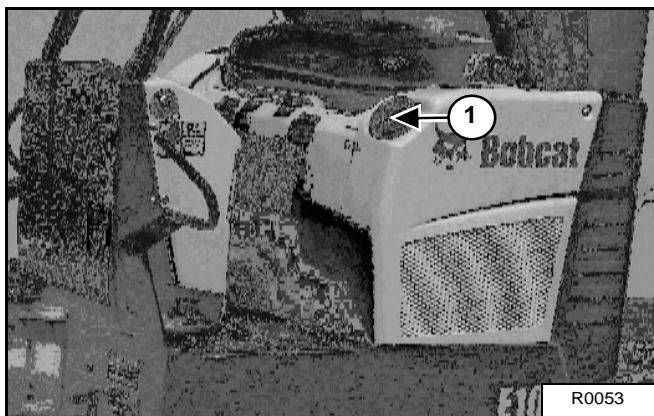

Remove the fuel fill cap (Item 1) under the left console using the key [Figure 86].

Use a clean, approved safety container to add fuel. Add fuel only in an area that has a free movement of air and no flames or sparks. **NO SMOKING!**

Install and tighten the fuel fill cap.

(See SERVICE SCHEDULE on Page 64.) for the service interval when to remove water from or replace the fuel filter.

**Removing Water From The Fuel Filter**

Open the tailgate.

**Figure 87**

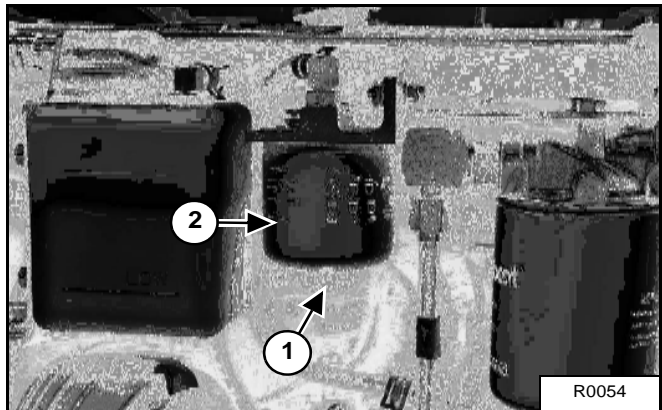

Loosen the drain (Item 1) [Figure 87] at the bottom of the filter to drain water from the filter.

**Replacing The Fuel Filter**

Remove the filter (Item 2) [Figure 87].

Clean the area around the filter housing. Put clean oil on the seal of the new filter. Install the fuel filter and tighten by hand.

Remove the air from the fuel system. (See Removing Air From The Fuel System on Page 70.)

**Draining The Fuel Tank**

To remove the fuel line at the engine and put the end of the hose in a fuel can, squeeze the primer bulb (if equipped) and drain the fuel tank that way (siphon action).

(See SERVICE SCHEDULE on Page 64.) for the correct service interval.

**FUEL SYSTEM (CONT'D)**

**Removing Air From The Fuel System**

After replacing the fuel filter or when the fuel tank has run out of fuel, air must be removed from the fuel system before starting the engine.

**Figure 88**

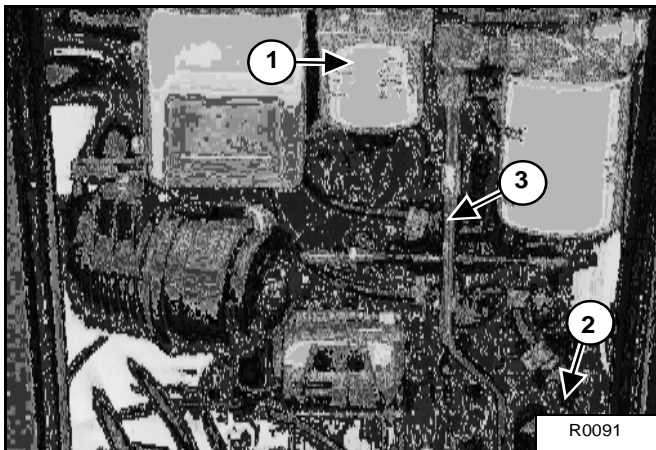

Open the fuel filter vent (Item 1) [Figure 88].

Operate the hand pump (priming bulb) (Item 2) [Figure 88] until the fuel flows from the vent with no air bubbles.

Close the vent (Item 1) [Figure 88] on the fuel filter housing.

Start the engine and let it run at low idle. It can be necessary to open the vent at the fuel injection pump (Item 3) [Figure 88] briefly until the engine runs smoothly.

**! WARNING**

**AVOID INJURY OR DEATH**

Diesel fuel or hydraulic fluid under pressure can penetrate skin or eyes, causing serious injury or death. Fluid leaks under pressure may not be visible. Use a piece of cardboard or wood to find leaks. Do not use your bare hand. Wear safety goggles. If fluid enters skin or eyes, get immediate medical attention from a doctor familiar with this injury.

W-2072-EN-0909

**ENGINE LUBRICATION SYSTEM**

**Checking Engine Oil**

Check the engine oil every day before starting the engine for the work shift.

**Figure 89**

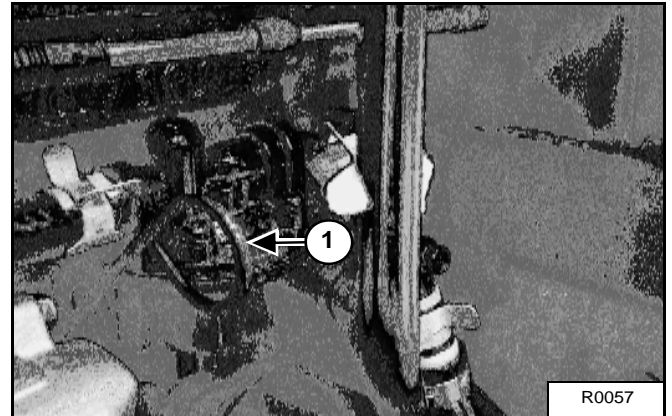

Open the rear door and remove the dipstick (Item 1) [Figure 89].

Keep the oil level between the marks on the dipstick.

**Figure 90**

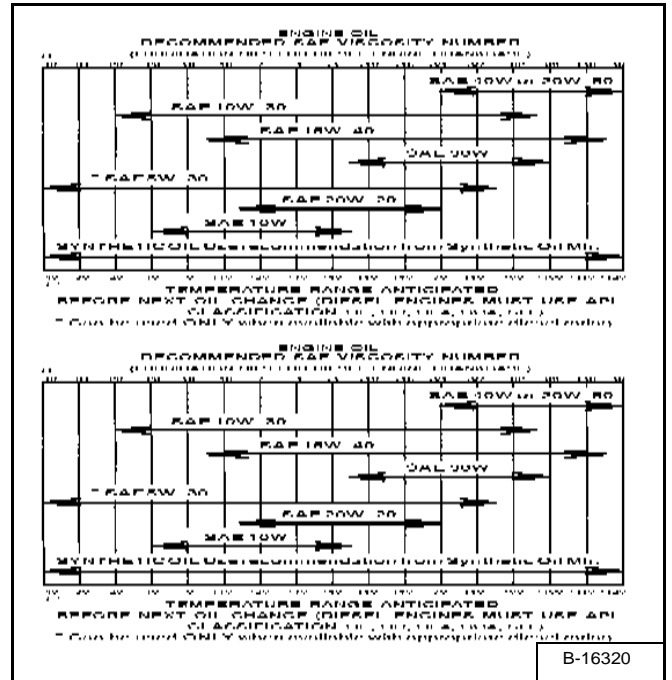

Use a good quality motor oil that meets the correct API Service Classification [Figure 90].

## ENGINE LUBRICATION SYSTEM (CONT'D)

### Replacing Oil And Filter

(See SERVICE SCHEDULE on Page 64.) for the service interval for replacing the engine oil and filter.

Run the engine until it is at operating temperature. Stop the engine.

Open the tailgate.

Figure 91

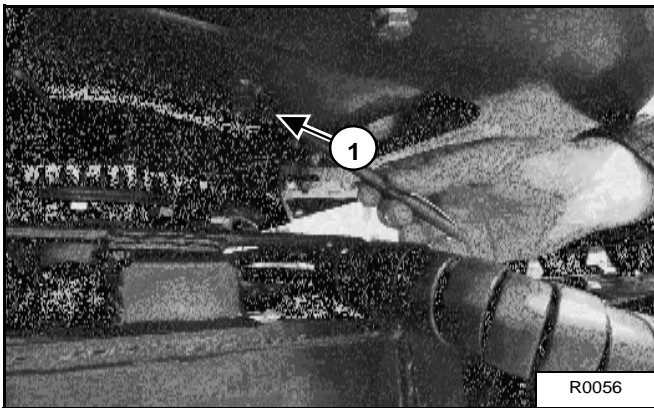

Remove the drain plug (Item 1) [Figure 92] from the drain hose. Drain the oil into a container and recycle or dispose of used oil in an environmentally safe manner.

Figure 92

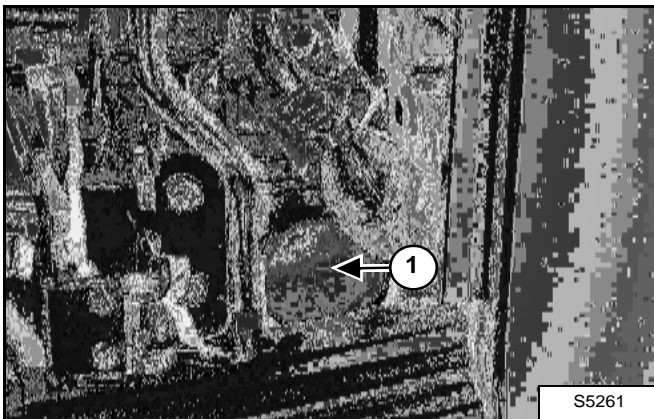

Remove the oil filter (Item 1) [Figure 92] and clean the filter housing surface.

Use a genuine Bobcat filter.

Put clean oil on the filter gasket.

Install the filter and tighten by hand.

Install and tighten the oil drain plug.

Figure 93

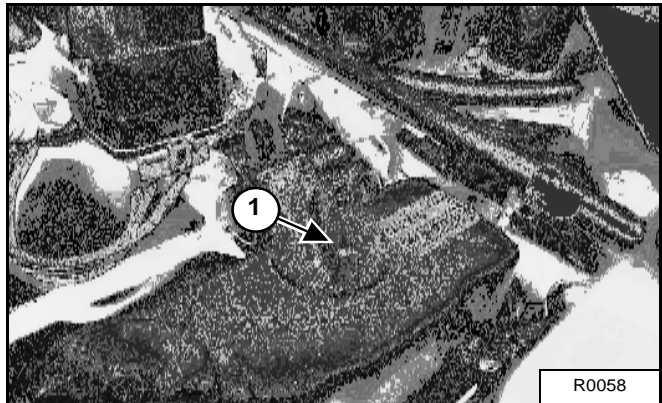

Remove the fill cap (Item 1) [Figure 93].

Put 3.5 L of oil into the engine.

Use a good quality motor oil that meets the correct API Service Classification [Figure 90].

Install the fill cap.

Start the engine and let it run for several minutes.

Stop the engine. Check for leaks at the oil filter. Check the oil level.

Add oil as needed if it is not at the top mark on the dipstick.

**COOLING SYSTEM**

Check the cooling system every day to prevent overheating, loss of performance or engine damage.

**Cleaning The Cooling System**

Open the tailgate.

Use air pressure or water pressure to clean the radiator and oil cooler.

**Checking The Coolant Level**

**! WARNING**

**AVOID BURNS**

Do not remove radiator cap when the engine is hot. You can be seriously burned.

W-2070-1203

**! WARNING**

Wear safety glasses to prevent eye injury when any of the following conditions exist:

- When fluids are under pressure.
- Flying debris or loose material is present.
- Engine is running.
- Tools are being used.

W-2019-1285

**Figure 94**

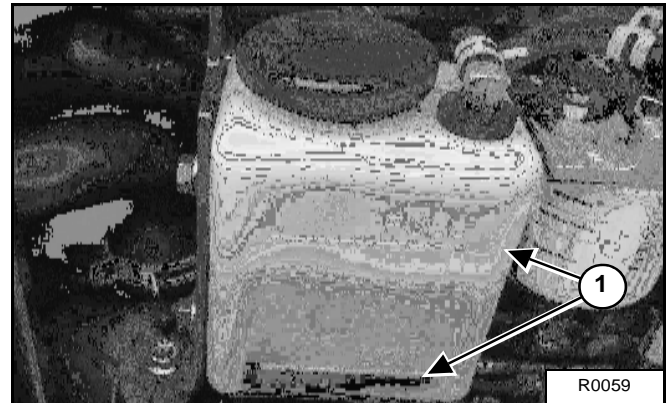

The coolant level must be between the marks (Item 1) [Figure 94] on the coolant recovery tank.

**IMPORTANT**

**AVOID ENGINE DAMAGE**

Always use the correct ratio of water to antifreeze. Too much antifreeze reduces cooling system efficiency and can cause serious premature engine damage.

Too little antifreeze reduces the additives which protect the internal engine components; reduces the boiling point and freeze protection of the system. Always add a premixed solution. Adding full strength concentrated coolant can cause serious premature engine damage.

I-2124-0497



**COOLING SYSTEM (CONT'D)**

**Replacing The Coolant**

(See SERVICE SCHEDULE on Page 64.) for correct service intervals.



**AVOID BURNS**

**Do not remove radiator cap when the engine is hot. You can be seriously burned.**

W-2070-1203

When the engine is cool, remove the radiator cap (Item 1) [Figure 94].

**Figure 95**



Open the drain valve (Item 1) [Figure 95] on the engine block and drain the coolant into a container.

After all the coolant is removed, close the drain valve.

Recycle or dispose of the used coolant in an environmentally safe manner.

Mix the coolant in a separate container.

**NOTE: The cooling system is factory filled with propylene glycol (purple colour). DO NOT mix propylene glycol with ethylene glycol.**

**Figure 96**

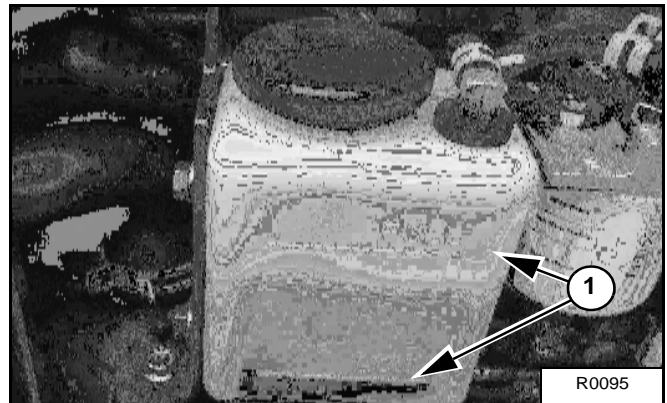

The coolant level must be between the marks (Item 1) [Figure 96] on the coolant recovery tank.

If the coolant is low, add premixed coolant to the coolant recovery tank; 47% water and 53% propylene glycol.

1.6 litres of propylene glycol mixed with 1.4 litres of water is the correct mixture of coolant to provide a -37°C freeze protection.



**AVOID ENGINE DAMAGE**

**Always use the correct ratio of water to antifreeze. Too much antifreeze reduces cooling system efficiency and can cause serious premature engine damage.**

**Too little antifreeze reduces the additives which protect the internal engine components; reduces the boiling point and freeze protection of the system. Always add a premixed solution. Adding full strength concentrated coolant can cause serious premature engine damage.**

I-2124-0497

Use a refractometer to check the condition of propylene glycol in your cooling system.

Add premixed coolant until the level is correct.

Run the engine until it is at operating temperature. Stop the engine. Check the coolant level and add as needed. Install the radiator cap and tighten.

Add coolant to the recovery tank as needed.

Close the tailgate.

## ALTERNATOR BELT

### Adjusting The Alternator Belt

Replace the belt if it has stretched or there are cracks in the belt. Replace the pulley if the belt makes contact with the bottom of the groove in the pulley.

Stop the engine.

**Figure 97**

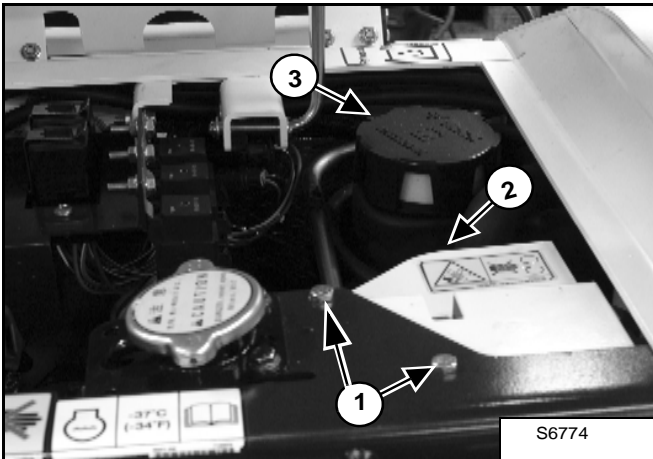

Remove the two bolts (Item 1) and remove the fan apron (Item 2) [Figure 97].

Remove the fill cap (Item 3) [Figure 97] from the hydraulic reservoir.

**Figure 98**

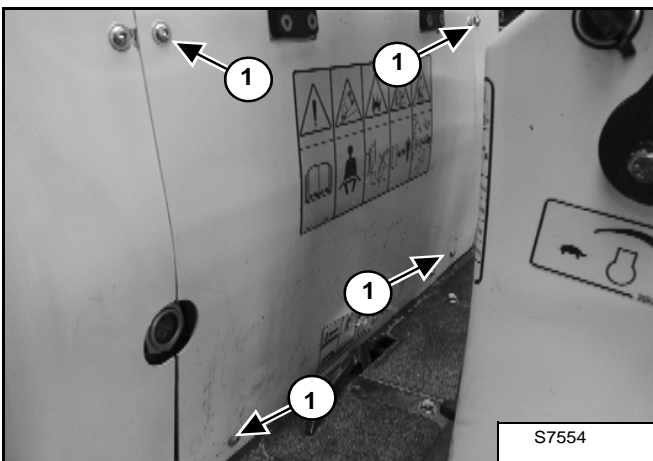

Remove the four bolts (Item 1) [Figure 98].

Remove the cover.

**Figure 99**



Loosen the upper alternator bolt using a bowed key wrench [Figure 99].

## ALTERNATOR BELT (CONT'D)

### Adjusting The Alternator Belt (Cont'd)

Figure 100

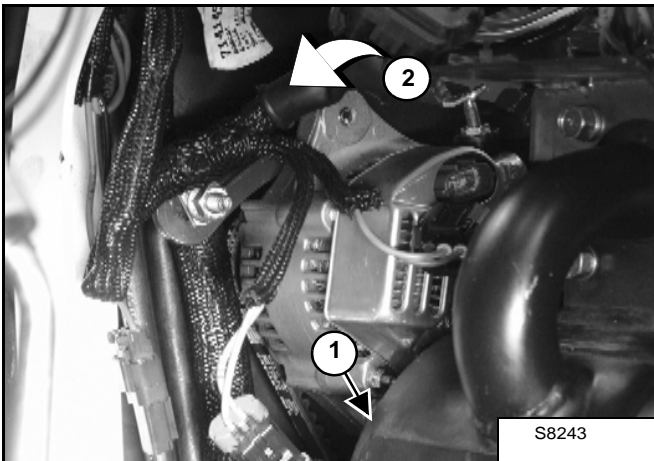

Loosen the lower alternator mounting and adjustment bolt (Item 1) [Figure 100].

Figure 101

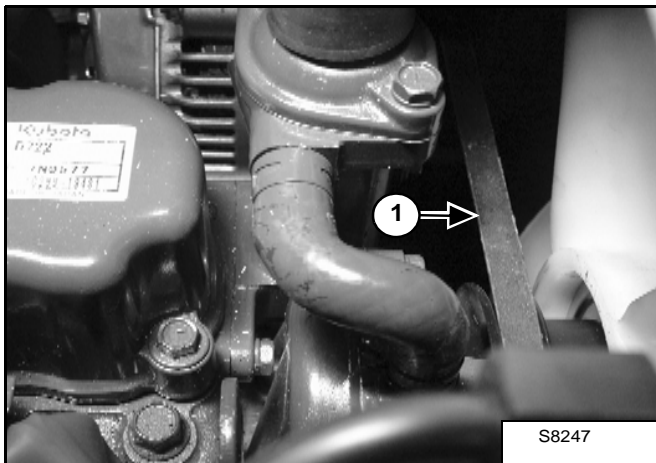

If a belt tension tool is available, move the alternator toward the front of the machine (Item 2) [Figure 100] until the belt (Item 1) [Figure 101] has (New belt = 56 to 60 lbf. or Used belt = 48 to 52 lbf.) tension.

If a belt tension tool is not available, move the alternator toward the front of the machine (Item 2) [Figure 100] until the belt (Item 1) [Figure 101] has 0.50 in. (13 mm) movement at the middle of the belt span with 13 lb. (58 N) of force.

Tighten the mounting and adjustment bolts.

Install the cover, fill cap and fan apron.

## ELECTRICAL SYSTEM

### Description

Figure 102

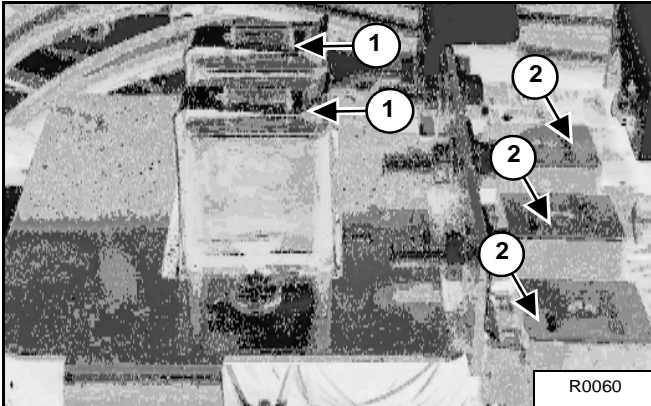

The excavator has a 12 volt, negative ground electrical system. The electrical system is controlled by fuses and relays located on top of the engine compartment (1 & 2) [Figure 102]. The fuses will protect the electrical system when there is an electrical overload. The reason for the overload must be found before starting the engine again.

### Fuses

Figure 103

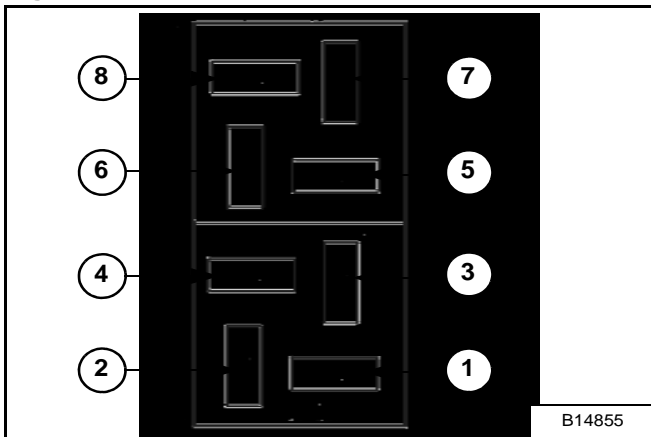

1. Power Socket - 15 A
2. Ignition - 10 A (SW)
3. Timer - 25 A (UNSW)
4. Beacon - 10 A
5. Switch Power - 10 A
6. Valves horn - 10 A
7. Switched timer - 10 A
8. Light - 10 A

Always replace fuses using the same type and capacity.

### Relays And Diodes

The three electrical relays (Item 2) [Figure 102] are located on top of engine compartment. The three relays control the starter, glow plugs and switched power circuits.

Figure 104



The fuel shut-off timer (Item 1) [Figure 104] is located on top of the engine compartment.

Figure 105

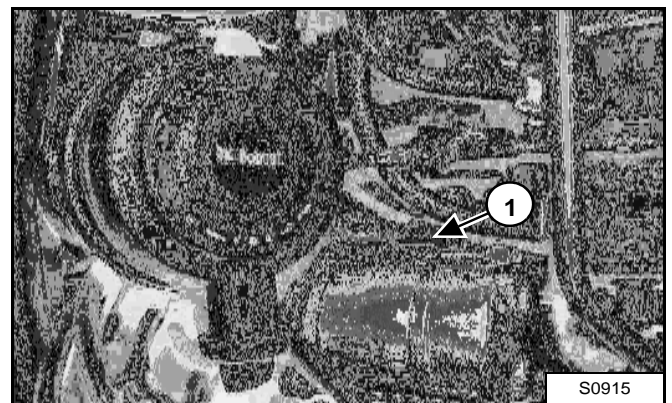

There are 2 diodes in the harness behind the starter (Item 1) [Figure 105]. The starter is located next to the cleaner, behind the access panel under the seat. The diodes are for alternator feedback protection and the glow plug during start function.

ELECTRICAL SYSTEM (CONT'D)

Servicing The Electrical System And Battery

Figure 106

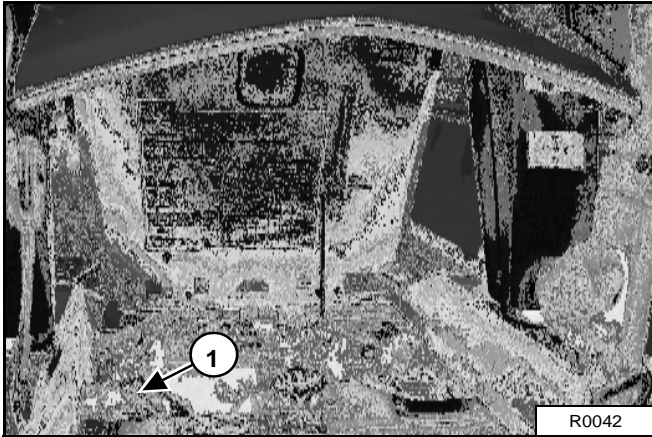

Open the tailgate to gain access to the battery (Item 1), located on top of the engine compartment [Figure 106].

Figure 107

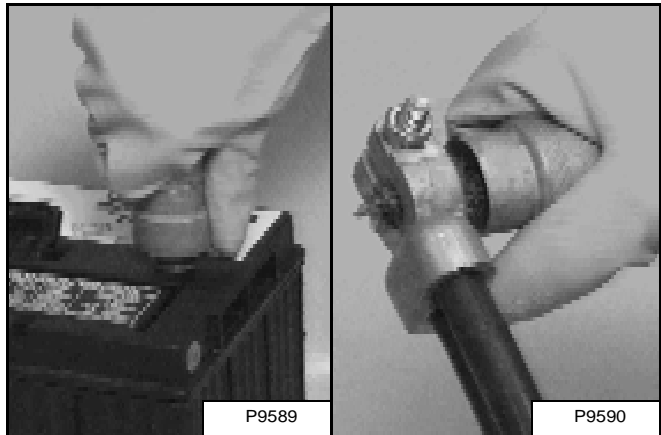

The battery cables must be clean and tight [Figure 107]. Remove acid or corrosion from the battery and cables using a sodium bicarbonate and water solution. Cover the battery terminals and cable ends with battery saver grease to prevent corrosion.

Check for broken or loose connections.

If the battery cables are removed for any reason, disconnect the negative (-) cable first. When installing the battery cables, make the last connection the negative (-) cable to the battery.

The original equipment battery is maintenance free. If a replacement battery is installed, check the electrolyte level in the battery.

If the electrolyte level is lower than 13 mm above the plates, add distilled water only.

**! WARNING**

Batteries contain acid which burns eyes and skin on contact. Wear goggles, protective clothing and rubber gloves to keep acid off body.

In case of acid contact, wash immediately with water. In case of eye contact get prompt medical attention and wash eye with clean, cool water for at least 15 minutes.

If electrolyte is taken internally drink large quantities of water or milk! DO NOT induce vomiting. Get prompt medical attention.

W-2065-1296

## ELECTRICAL SYSTEM (CONT'D)

### Using A Booster Battery (Jump Starting)

# IMPORTANT

If jump starting the excavator from a second machine:

When jump starting the excavator from a battery installed in a second machine, make sure the engine is **NOT** running while using the glow plugs. High voltage spikes from a running machine can burn out the glow plugs.

I-2060-0906

If it is necessary to use a booster battery to start the engine, **BE CAREFUL!** There must be one person in the operator's seat and one person to connect and disconnect the battery cables.

Engage the upperstructure slew lock. Be sure the key switch is OFF. The booster battery must be 12 volt.

Figure 108



Remove the cover to the left of the operator's seat to access the battery.

Connect one end of the first cable to the positive (+) terminal of the booster battery. Connect the other end of the same cable to the positive (+) terminal (Item 1) [Figure 108] of the excavator battery.

Figure 109



Connect one end of the second cable to the negative (-) terminal of the booster battery. Connect the other end of the same cable to the bolt at the front left corner of the excavator (Item 1) [Figure 109].

# IMPORTANT

Damage to the alternator can occur if:

- Engine is operated with battery cables disconnected.
- Battery cables are connected when using a fast charger or when welding on the excavator. (Remove both cables from the battery.)
- Extra battery cables (booster cables) are connected wrong.

I-2222-0903

Start the engine. After the engine has started, remove the negative (-) cable first (Item 1) [Figure 109].

Disconnect the cable from the excavator battery (Item 1) [Figure 108].

ELECTRICAL SYSTEM (CONT'D)

Removing And Installing The Battery

**! WARNING**

Batteries contain acid which burns eyes and skin on contact. Wear goggles, protective clothing and rubber gloves to keep acid off body.

In case of acid contact, wash immediately with water. In case of eye contact get prompt medical attention and wash eye with clean, cool water for at least 15 minutes.

If electrolyte is taken internally drink large quantities of water or milk! DO NOT induce vomiting. Get prompt medical attention.

W-2065-1296

Figure 110

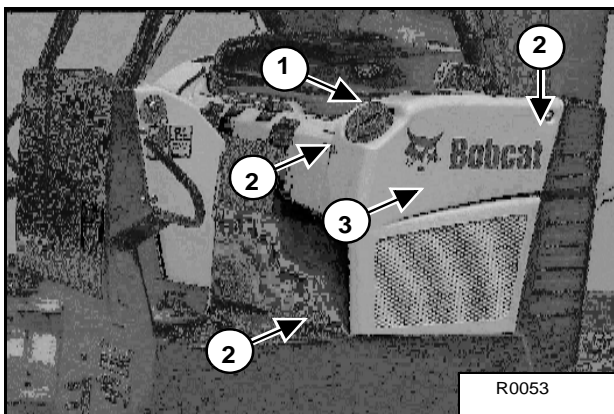

The battery is located to the left of the operator's seat. Remove the fuel cap (Item 1) with the start key and then the 3 bolts (Item 2) to remove the cover (Item 3) [Figure 110].

**NOTE:** Put back the fuel cap as soon as the cover is removed, to avoid fuel vapor.

Figure 111

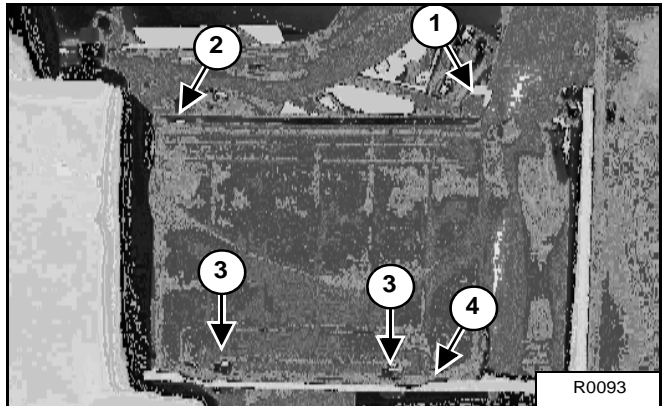

Disconnect the negative (-) cable (Item 1) [Figure 111] first.

Disconnect the positive (+) cable (Item 2) [Figure 111].

Loosen the bolts (Item 3) [Figure 111] and remove the hold down clamp (Item 4) to remove the battery.

Always clean the terminals and the cable ends, even when installing a new battery.

Install the battery. Install the hold down clamp and tighten the bolts.

Connect the battery cables. Connect the negative (-) cable (Item 1) [Figure 111] last to prevent sparks.

To replace the cover, first remove the fuel cap (Item 1) again, install the cover and tighten the 3 bolts (Item 2). Finally put back the fuel cap using the start key [Figure 110].

**! WARNING**

Batteries contain acid which burns eyes and skin on contact. Wear goggles, protective clothing and rubber gloves to keep acid off body.

In case of acid contact, wash immediately with water. In case of eye contact get prompt medical attention and wash eye with clean, cool water for at least 15 minutes.

If electrolyte is taken internally drink large quantities of water or milk! DO NOT induce vomiting. Get prompt medical attention.

W-2065-1296

## HYDRAULIC SYSTEM

### Checking And Adding Hydraulic Oil

Put the machine on a level surface.

Retract the arm and bucket cylinders, put the bucket on the ground and raise the blade. Stop the engine.

Figure 112

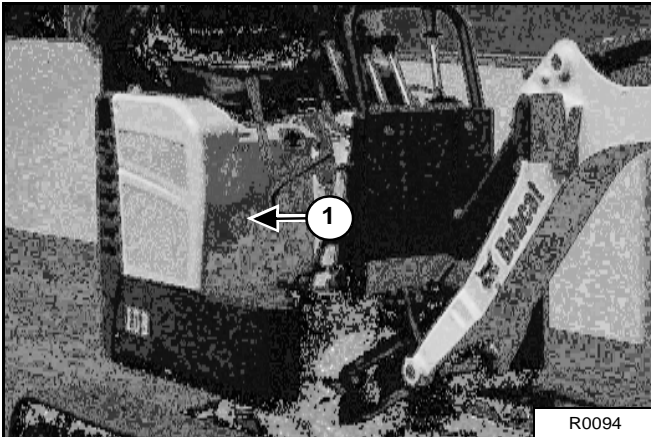

The fluid must be at the centre of the sight gauge (Item 1) [Figure 112].

Figure 113

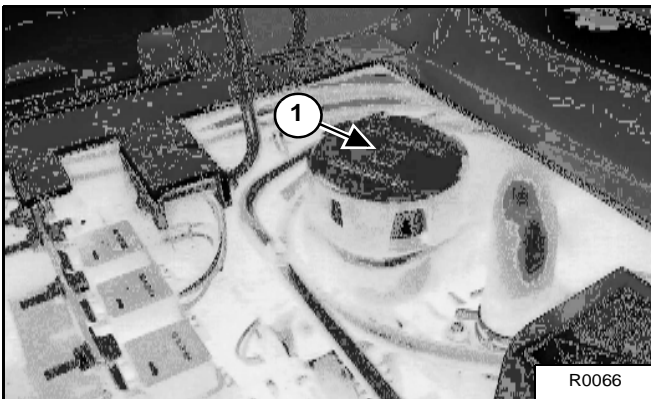

Open the tailgate. Remove the oil fill cap (Item 1) [Figure 113]. Check the condition of the screen in the fill neck of the reservoir. The screen must be installed in the fill neck when adding oil.

Add the correct fluid to the reservoir until it is at the centre of the sight gauge (Item 1) [Figure 112].

Install the cap. Close the tailgate.

## WARNING

Always clean up spilled fuel or oil. Keep heat, flames, sparks or lighted tobacco away from fuel and oil. Failure to use care around combustibles can cause explosion or fire which can result in injury or death.

W-2103-1285

### Replacing The Hydraulic Filter

(See SERVICE SCHEDULE on Page 64.) for the correct service interval.

Open the tailgate.

Figure 114

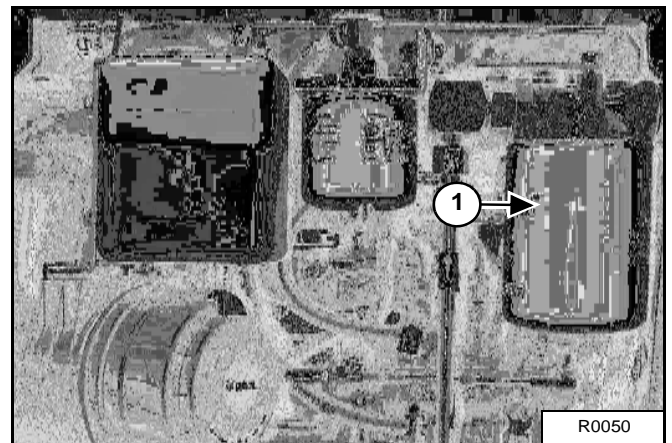

Remove the filter (Item 1) [Figure 114].

Clean the housing where the filter gasket makes contact.

Put clean hydraulic fluid on the gasket. Install the new filter and tighten by hand only.

Start the engine. Run the excavator through the hydraulic functions. Stop the engine. Check the fluid level at the sight gauge (Item 1) [Figure 112] and add as needed. Check the filter area for leaks.



## HYDRAULIC SYSTEM (CONT'D)

### Draining Hydraulic Oil

(See SERVICE SCHEDULE on Page 64.) for the correct service interval.

Retract the arm and bucket cylinders, lower the bucket to the ground. Stop the engine.

Figure 115

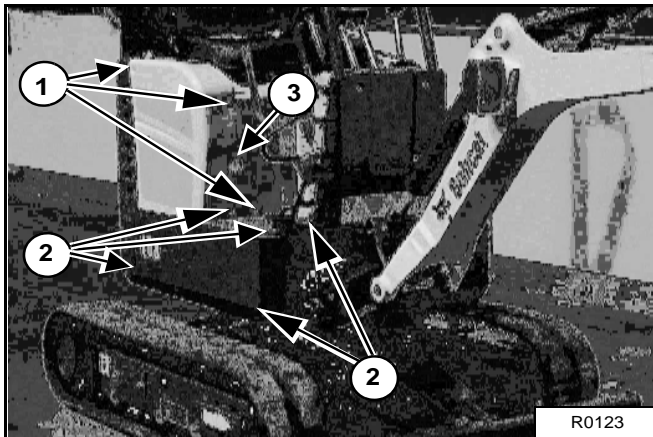

To gain access to drain the hydraulic oil, loosen the three bolts (Item 1) from the cover [Figure 115]. Pivot the cover downwards. Then remove the black protection on the floor by loosening the bolts (Item 2).

Figure 116

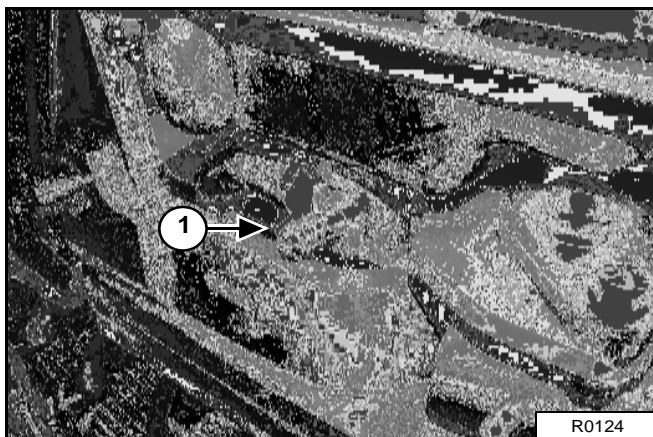

Before removing the cap, place a container under the drain plug (Item 1) to collect the oil [Figure 116].

## IMPORTANT

Fluid such as engine oil, hydraulic fluid, coolants, grease, etc. must be disposed of in an environmentally safe manner. Some regulations require that certain spills and leaks on the ground must be cleaned in a specific manner. See local bylaws for the correct disposal.

I-2067-EN-1009

## IMPORTANT

If the fluid is being drained because of a system failure, remove and clean all hydraulic lines.

I-2045-0788

Install the cap again.

Add fluid to the reservoir until it is at the centre of the sight gauge (Item 3) [Figure 115].

Run the excavator through the hydraulic functions. Stop the engine. Check the fluid level and add as needed.

Replace the black protection and the cover.

## HYDRAULIC SYSTEM (CONT'D)

### Diagnostic Connectors

Figure 117

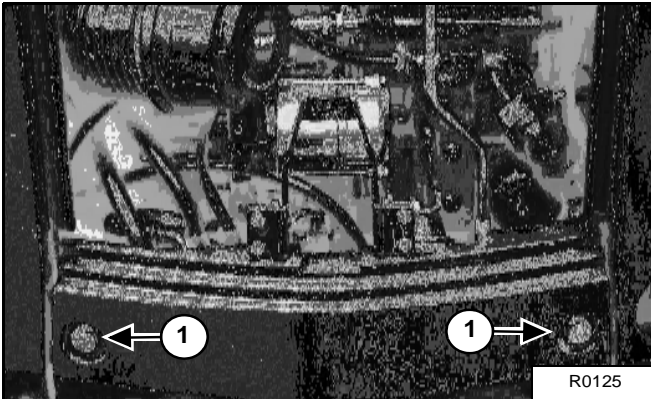

To gain access, remove the counterweight by loosening the two bolts (Item 1) [Figure 117].

The connectors can be used by your Bobcat dealer to check circuit pressures.

Figure 118

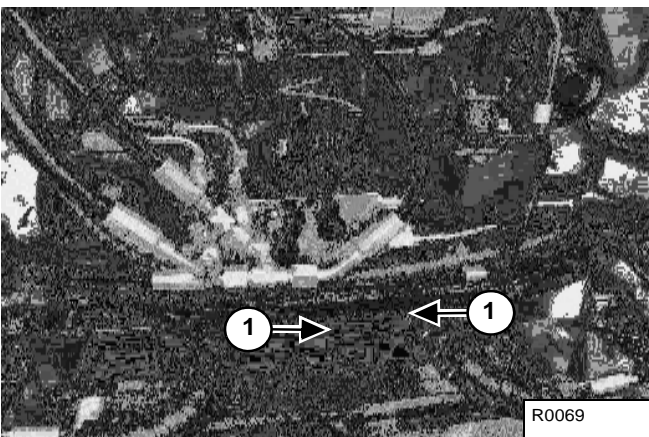

The 2 diagnostic connectors (Item 1) [Figure 118] are located on the hydraulic block.

## CONTROL CONSOLE LOCKOUTS

### Inspection And Maintenance

Figure 119

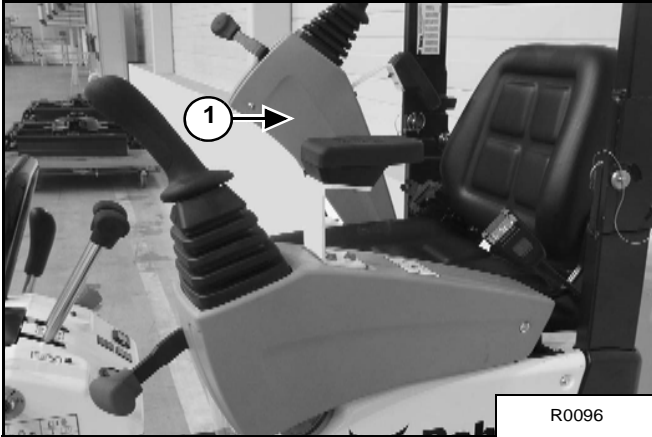

When a console is raised [Figure 119], the hydraulic control joysticks and traction system must not function.

Figure 120

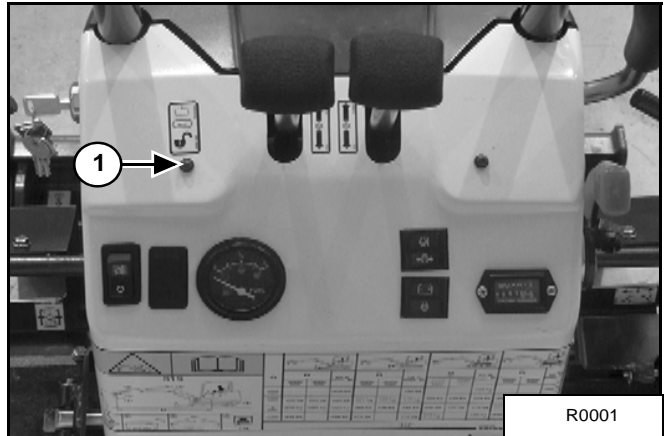

Sit in the operator's seat, fasten the seat belt and start the engine.

Raise the right console (Item 1) [Figure 119]. The green light (Item 1) [Figure 120] on the console will go off.

Move the joystick control levers. There should be no movement of the boom, arm, slew or bucket.

Move the steering control levers. There should be no movement of the excavator tracks.

Lower the right console. Raise the left console and repeat the inspection procedure.

The joystick control levers and traction system must be deactivated when either console is raised.

Service the system if these controls do not deactivate when a control console is raised. (See your Bobcat® dealer for service.)

**SPARK ARRESTER MUFFLER**

**Cleaning Procedure**

**Figure 121**

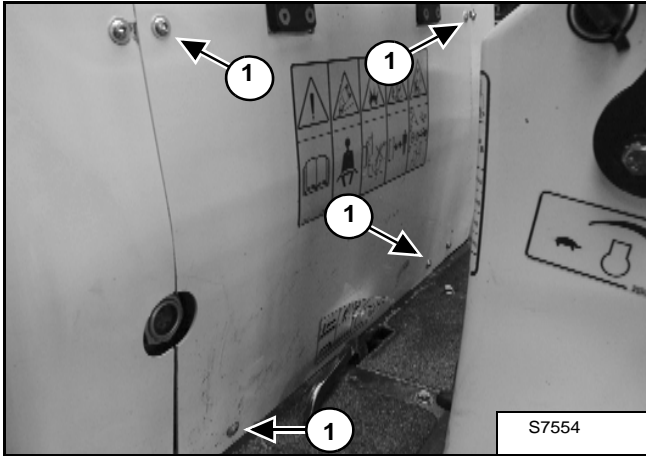

Remove the four bolts (Item 1) [Figure 121].

Remove the cover.

(See SERVICE SCHEDULE on Page 64.) for the correct service interval.

Do not operate the excavator with a defective exhaust system.

Stop the engine. Open the tailgate.

**Figure 122**

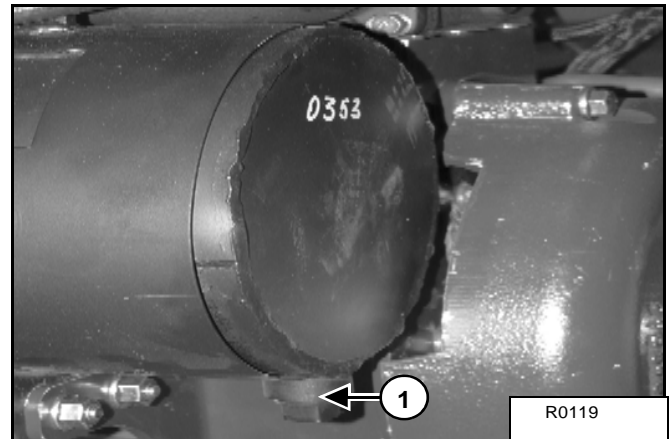

Remove the plug (Item 1) [Figure 122] from the bottom of the muffler.

Start the engine and run for about ten seconds while a second person, wearing safety glasses, holds a piece of wood over the outlet of the muffler. (The carbon deposits will be forced out of the muffler cleanout hole.)

Stop the engine. Install and tighten the plug.

Tighten the bolts.

Install the cover.

Close the tailgate.

**! WARNING**

Stop engine and allow the muffler to cool before cleaning the spark chamber. Wear safety goggles. Failure to obey can cause serious injury.

W-2011-1285

**! WARNING**

When the engine is running during service, the steering levers must be in neutral. Failure to do so can cause injury or death.

W-2203-0595

**! WARNING**

Never use machine in atmosphere with explosive dust or gases or where exhaust can contact flammable material. Failure to obey warnings can cause injury or death.

W-2068-1285

## TRACK TENSION

**NOTE:** The wear of undercarriage parts varies with working conditions and types of soil conditions. Maintain the correct track tension by inspecting regularly. (See **SERVICE SCHEDULE** on Page 64.) for the correct service interval.

### Adjusting

Figure 123

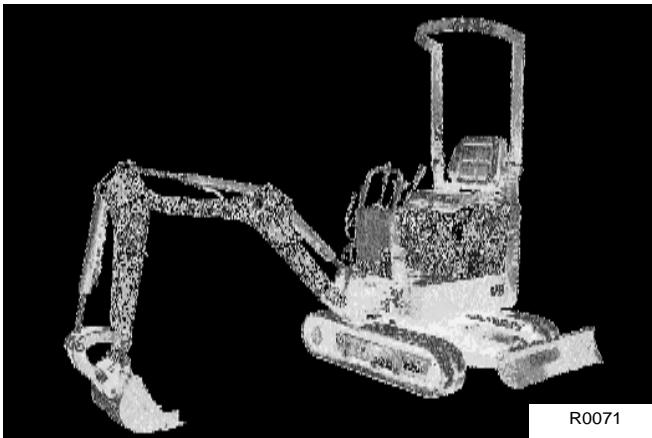

Raise one side of the machine (approximately 102 mm) using the boom and arm as shown in **[Figure 123]**.

Figure 124

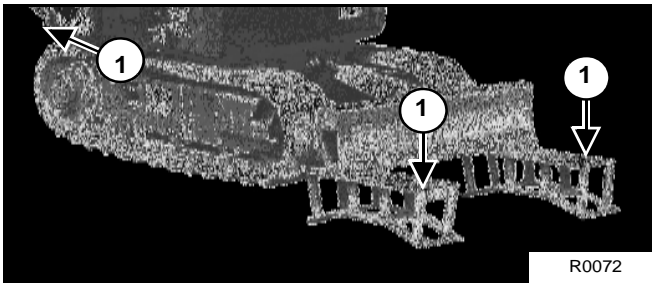

Raise the blade fully and install jackstands (Item 1) **[Figure 124]** under the blade and the track frame. Lower the machine until all machine weight is on the jackstands **[Figure 124]**.

Stop the engine.

Figure 125



Figure 126

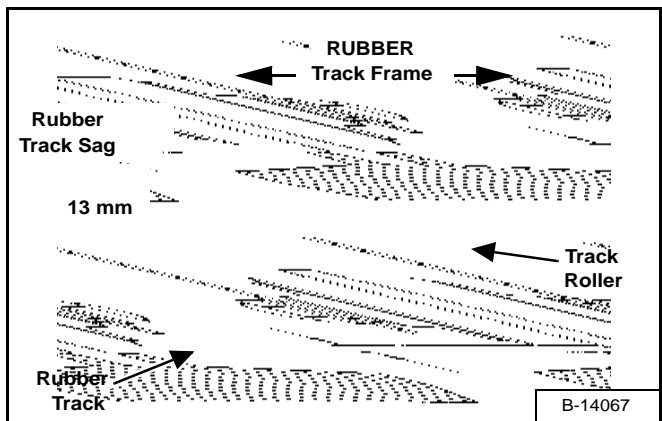
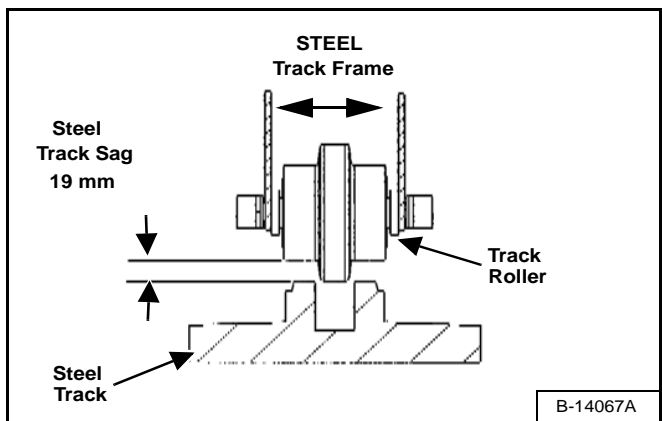

Figure 127



Measure the rubber or steel track (if equipped) sag at the middle track roller **[Figure 125]**. Do not get your fingers into pinch points between the track and the track roller. Use material of appropriate size to check the gap between the contact edge of the roller and top edge of the track guide lug **[Figure 125]**, **[Figure 126]** and **[Figure 127]**.

TRACK TENSION (CONT'D)

Figure 128

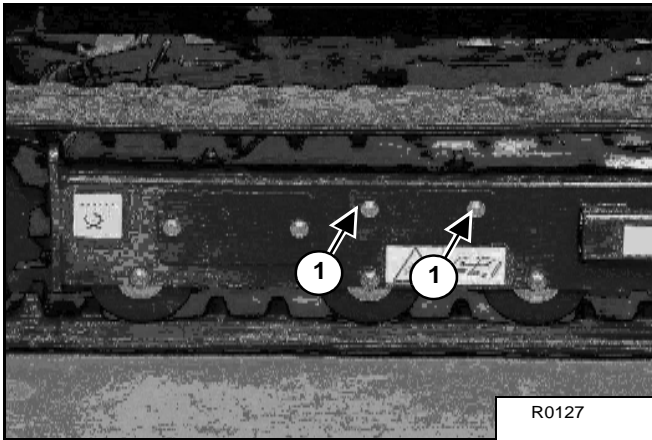

Loosen the two bolts (Item 1) [Figure 128] from the cover. Pivot the cover downwards.

Figure 129

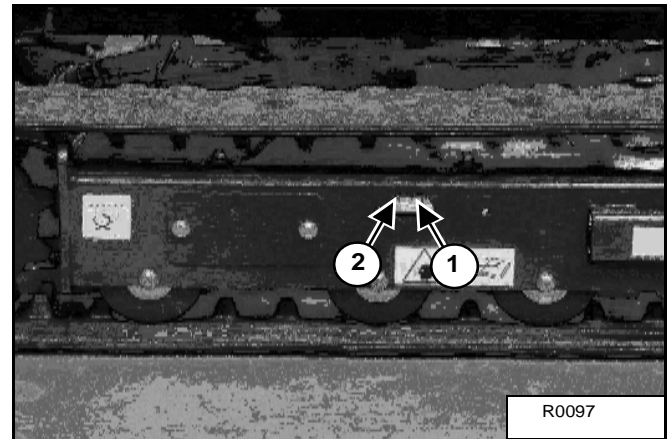

Add grease to the fitting (Item 1) [Figure 129] until the track tension is correct. If the tension is too tight, loosen the bleed screw (Item 2) [Figure 129] (1 turn maximum) and let grease flow out of the bleed screw. When tension is correct, tighten the bleed screw.

Repeat the procedure for the other side.

If the track tension is still loose after adjusting to the mentioned limit, it indicates the track is worn. See your dealer for repairs.

## DRIVE MOTOR

### Checking Oil Level

Figure 130

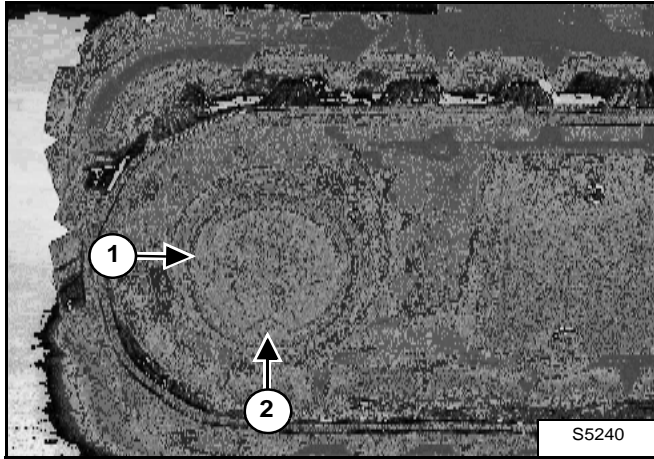

Put the machine on a level surface with the plugs positioned as shown (1 & 2) **[Figure 130]**.

Remove the top plug (Item 1) **[Figure 130]**. The oil level should be at the bottom edge of the plug hole.

Add gear lube through the plug hole if the oil level is below the hole.

Install and tighten the top plug.

Repeat the procedure for the other side.

### Draining The Drive Motor

(See SERVICE SCHEDULE on Page 64.) for the correct service interval.

Put the machine on a level surface with the plugs positioned as shown (1 & 2) **[Figure 130]**.

Remove the bottom plug (Item 2) and top plug (Item 1) **[Figure 130]** and drain into a container. Recycle or dispose of the used lubricant in an environmentally safe manner.

After all the gear lube is removed, install the bottom plug (Item 2) **[Figure 130]**.

Add gear lube to the top plug hole (Item 1) **[Figure 130]** until the gear lube level is at the bottom edge of the plug hole.

Install and tighten the top plug.

Repeat the procedure for the other side.

## BLADE EXTENSION

### Description

The blade extensions are used to match the blade width to the track width. Secure the blade extensions in the retracted position when transporting the excavator or when a narrow operating width is needed. Under normal operating conditions, the blade width should match the track width.

### Extending And Retracting

#### Extending

Figure 131

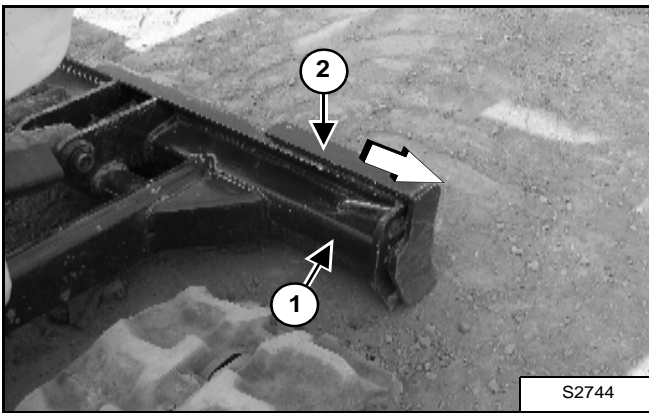

Raise the blade from the ground. Stop the engine.

Remove the pin (Item 1) [Figure 131].

Slide the blade extension (Item 2) [Figure 131] away from the blade frame into the extended position.

Secure the blade extension in the extended position with the pin.

#### Retracting

Figure 132

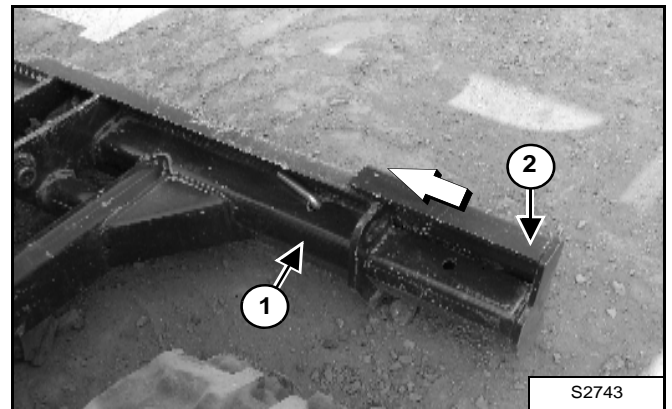

Raise the blade from the ground. Stop the engine.

Remove the pin (Item 1) [Figure 132].

Slide the blade extension (Item 2) [Figure 132] towards the blade frame into the retracted position.

Secure the blade extension in the retracted position with the pin.



## TRACK ROLLER AND IDLER LUBRICATION

### Procedure

The track rollers and idlers require no maintenance. The bearings are a sealed design.

## LUBRICATING THE EXCAVATOR

Lubricate the Hydraulic Excavator as specified in the SERVICE SCHEDULE. ((See SERVICE SCHEDULE on Page 64.) for the best performance of the machine).

Record the operating hours each time you lubricate the Hydraulic Excavator.

Always use a good quality lithium based multi-purpose grease when lubricating the excavator. Apply the lubricant until extra grease shows.

### Blade

Figure 133

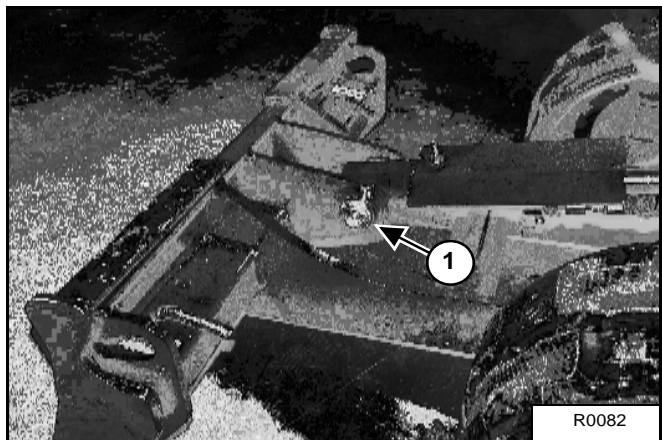

1. Blade Cylinder-Base End, every 8-10 hours (Item 1) [Figure 133].

Figure 134

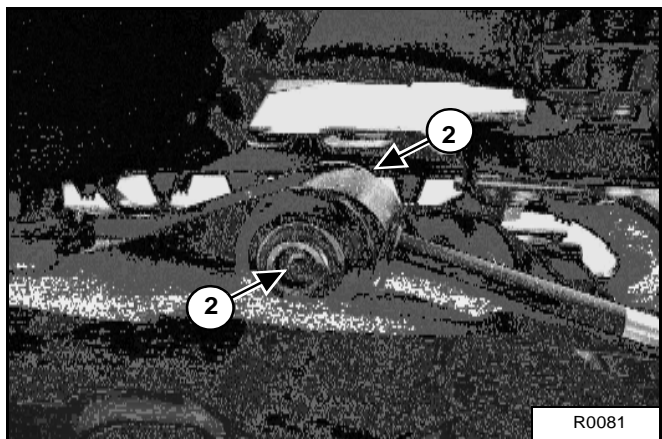

2. Blade Pivots, every 8-10 hours (Item 2) [Figure 134].

**LUBRICATING THE EXCAVATOR (CONT'D)**

**Boom Swing And Boom Base**

**Figure 135**

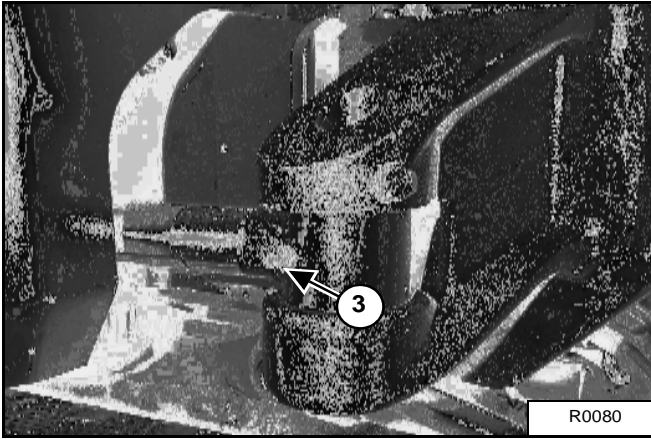

- 3. Boom Swing Cylinder, Rod End, every 8-10 hours (Item 1) [Figure 135].

**Figure 136**

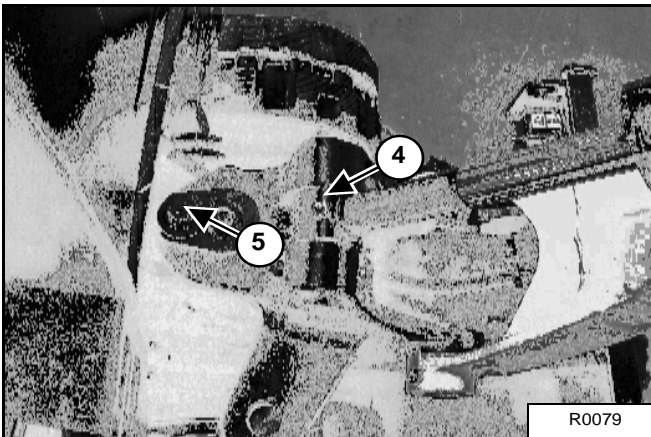

- 4. Boom Cylinder, Rod End (Item 1) [Figure 136].
- 5. Boom Swing Pivot, every 8-10 hours (Item 1) [Figure 136].

**Figure 137**

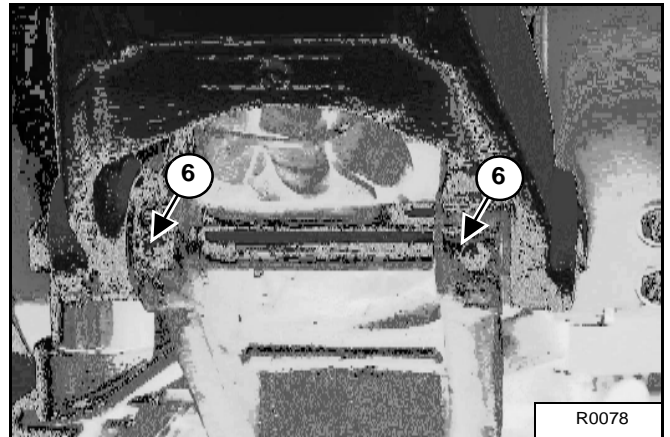

- 6. Boom, Base Pivot, every 8-10 hours (Item 2) [Figure 137].

**Boom, Middle**

**Figure 138**



- 7. Boom Cylinder, Base End, every 8-10 hours (Item 1) [Figure 138].
- 8. Arm Cylinder, Base End, every 8-10 hours (Item 1) [Figure 138].

**LUBRICATING THE EXCAVATOR (CONT'D)**

**Boom And Arm**

**Figure 139**

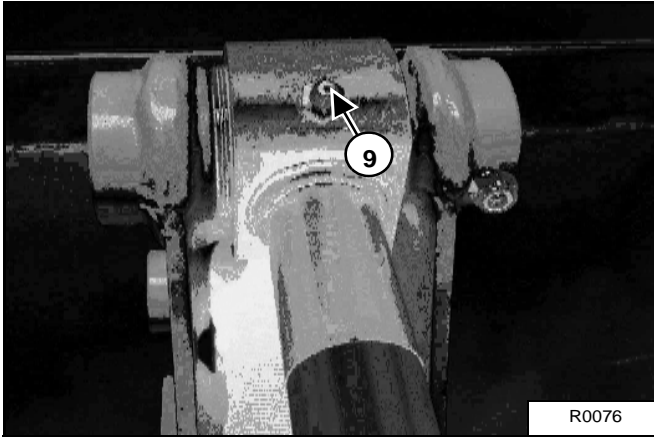

9. Arm Cylinder, Rod End, every 8-10 hours (Item 1) [Figure 139].

**Figure 140**

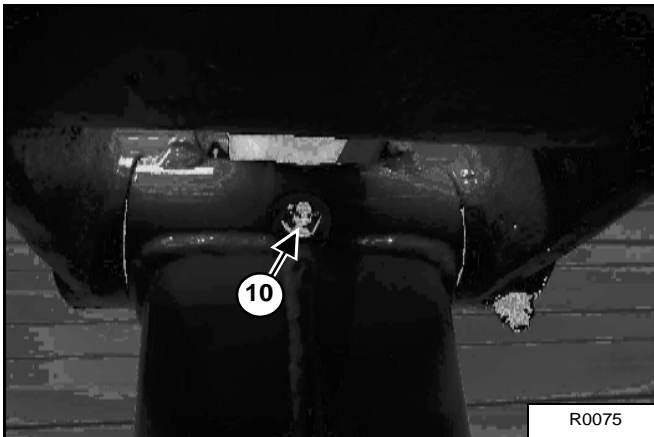

10. Arm Pivot, every 8-10 hours (Item 1) [Figure 140].

**Figure 141**

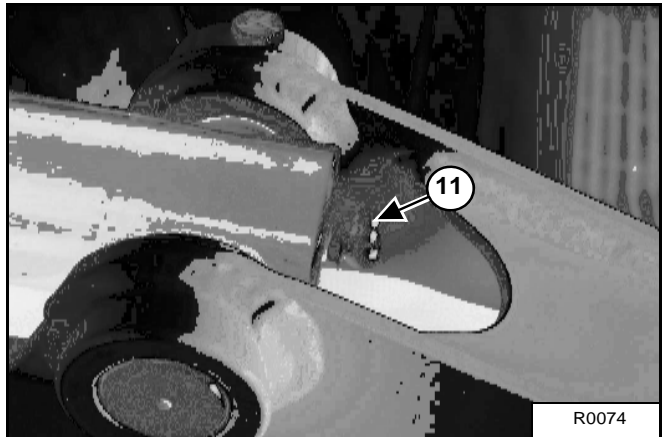

11. Bucket Cylinder, Base end, every 8-10 hours (Item 1) [Figure 141].

**Figure 142**

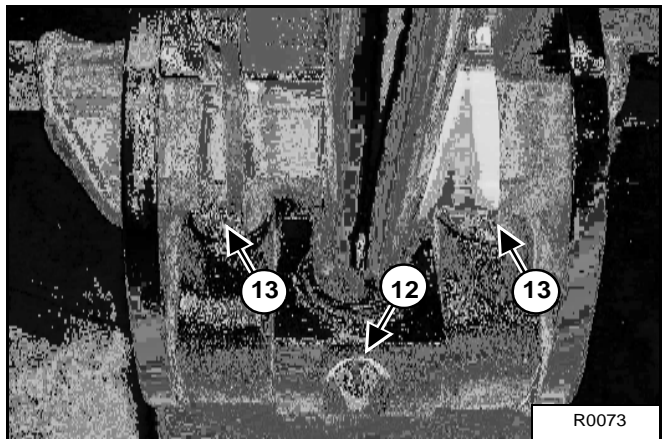

12. Bucket Cylinder, Rod end, every 8-10 hours (Item 1) [Figure 142].
13. Bucket Link, Bucket Cylinder Pivot, every 8-10 hours (Item 2) [Figure 142].

## LUBRICATING THE EXCAVATOR (CONT'D)

### Boom And Arm (Cont'd)

Figure 143

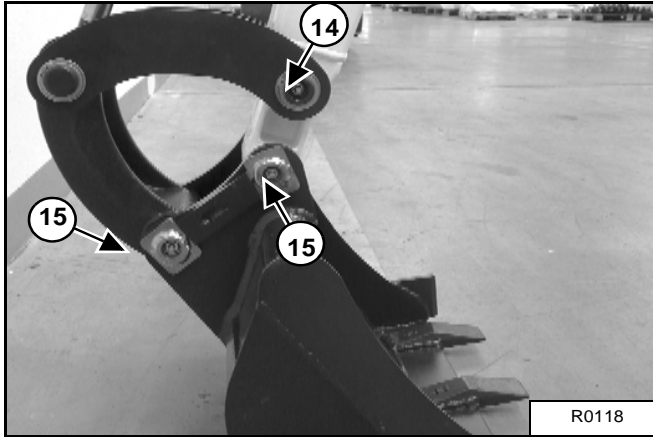

- 14. Bucket Link Pivot, every 8-10 hours (Item 1) [Figure 143].
- 15. Bucket Pivots, every 8-10 hours (Item 1) [Figure 143].

### Frame Fittings

Figure 144

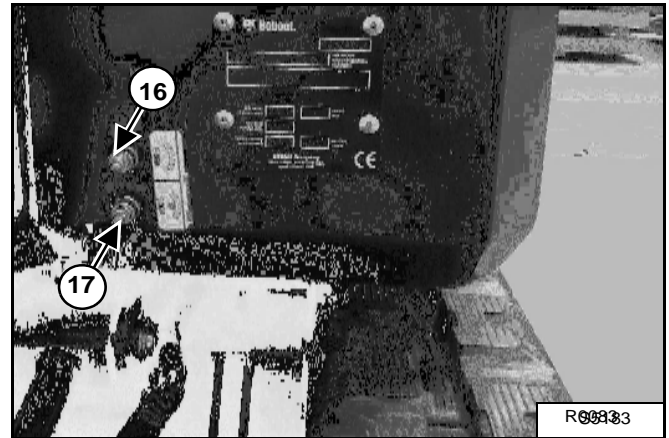

- 16. Swing Circle Bearing, every 50 hours (Item 2) [Figure 144].
- 17. Swing Circle Pinion, every 50 hours (Item 3) [Figure 144]. Pump 4 times with a grease gun. Rotate the upper structure 180° and repeat.

**NOTE:** Do not over-grease the swing circle; damage to the seal could result. Pump 4-5 times with a grease gun. Rotate the upperstructure 90° and repeat three more times.

### Track Expansion Tube

Figure 145

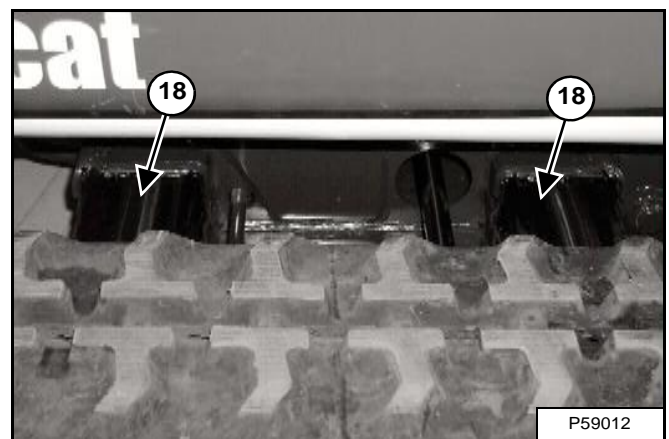

- 18. Track Expansion Tube, as required (Item 2) [Figure 145] (both sides).

**NOTE:** Spread lubriplate gearshield extra heavy grease evenly on wear surfaces on both sides of excavator as required.



## EXCAVATOR STORAGE AND RETURN TO SERVICE

### Storage

Sometimes it can be necessary to store your Bobcat Excavator for an extend period of time. Below is a list of items to perform before storage.

- Thoroughly clean the excavator including the engine compartment.
- Lubricate the excavator.
- Replace worn or damaged parts.
- Drive the excavator onto planks in a dry protected shelter.
- Lower the boom fully with the bucket flat on the ground.
- Put grease on any exposed cylinder rods.
- Put fuel stabiliser in the fuel tank and run the engine a few minutes to circulate the stabiliser to the pump and fuel injectors.
- Drain and flush the cooling system. Refill with premixed coolant.
- Replace all fluids and filters (engine, hydraulic).
- Replace all filters (i.e.: air cleaner, heater, etc.).
- Put all controls in neutral position.
- Remove the battery. Be sure the electrolyte level is correct then charge the battery. Store it in a cool dry place above freezing temperatures and charge it periodically during storage.
- Cover the exhaust pipe opening.
- Tag the machine to indicate that it is in storage condition.

### Return To Service

After the Bobcat Excavator has been in storage, it is necessary to follow a list of items to return the excavator to service.

- Check the engine and hydraulic oil levels; check coolant level.
- Install a fully charged battery.
- Remove grease from exposed cylinder rods.
- Check all belt tensions.
- Be sure all shields and guards are in place.
- Lubricate the excavator.
- Remove cover from exhaust pipe opening.
- Start the engine and let run for a few minutes while observing the instrument panels and systems for correct operation.
- Drive the excavator off of the planks.
- Operate machine, check for correct function.
- Stop the engine and check for leaks. Repair as needed.



## SPECIFICATIONS

EXCAVATOR SPECIFICATIONS .....	96
E10 Excavator Machine Dimensions .....	96
Working Range .....	97
Lift Capacity (Object Handling Applications Excluded) .....	98
Performance .....	99
Function Time .....	99
Weights .....	99
Controls .....	99
Engine .....	100
Electrical .....	100
Hydraulic System .....	100
Hydraulic Cylinders .....	101
Drive System .....	101
Traction .....	101
Fluid Capacities .....	102
Instrumentation .....	102
Fluid Specifications .....	102
Environmental .....	103
Temperature Range .....	103



**Bobcat®**



**EXCAVATOR SPECIFICATIONS**

**E10 Excavator Machine Dimensions**

- All dimensions are given in mm.
- Where applicable, specification conform to SAE or ISO standards and are subject to change without notice.

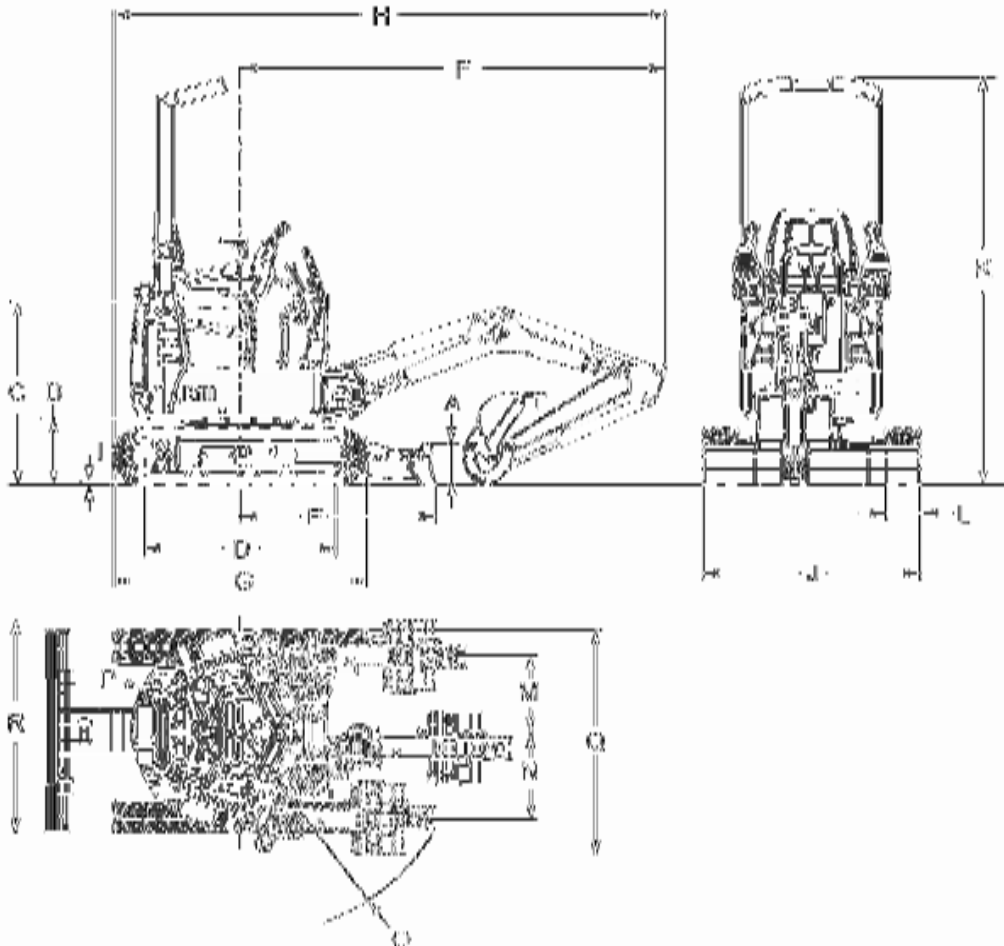

(A) Blade height	220 mm
(B) Clearance, upper structure to ground line	363 mm
(C) Ground line to top of engine cover	992 mm
(D) Length of track on ground	968 mm
(E) Machine centre line to blade	987 mm
(F) Minimum radius in travel position	2153 mm
(G) Overall length of track assembly	1280 mm
(H) Overall length in travel position	2793 mm
(I) Track lug height	16 mm
(J) Blade width (extensions not extended)	710 mm
(J) Blade width (extensions extended)	1100 mm
(K) Height	2209 mm
(L) Track width	180 mm
(M) Machine centre line to working equipment centre line, max left-hand rotation	413 mm
(N) Machine centre line to working equipment centre line, max right-hand rotation	471 mm
(O) Minimum turning radius	1121 mm
(P) Swing clearance, rear	550 mm
(Q) Working width at maximum right-hand rotation	1221 mm
(R) Working width at maximum left-hand rotation	1162 mm



**EXCAVATOR SPECIFICATIONS (CONT'D)**

**Working Range**

- All dimensions are given in mm.
- Where applicable, specification conform to SAE or ISO standards and are subject to change without notice.

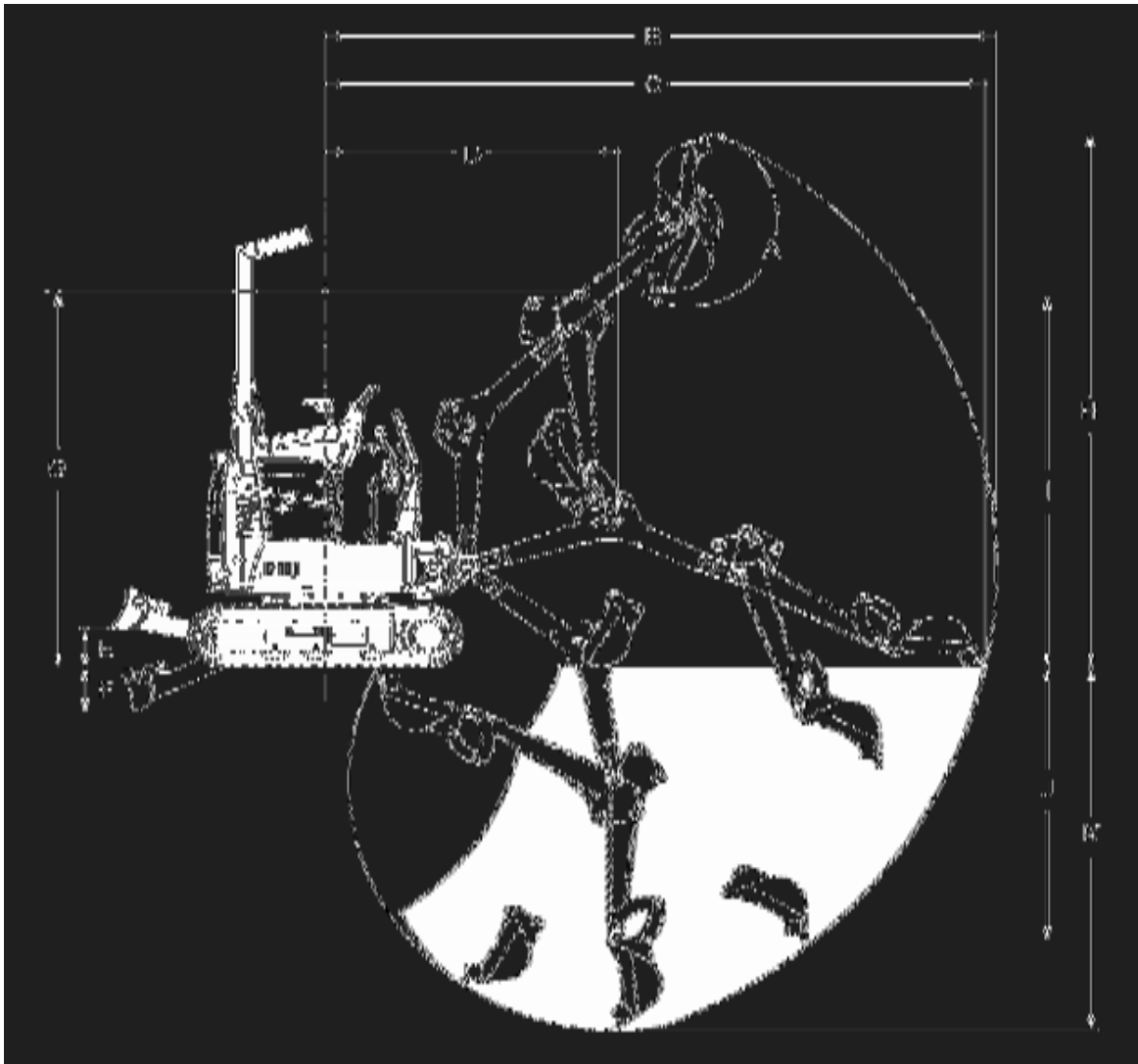

(A) Bucket pivot angle	196°
(B) Maximum reach of working equipment	3145 mm
(C) Maximum reach at ground level	3093 mm
(D) Maximum working equipment radius with boom at maximum height and dipperstick fully retracted	1374 mm
(E) Maximum blade height	196 mm
(F) Maximum blade depth	230 mm
(G) Maximum height of working equipment with dipperstick retracted	1899 mm
(H) Maximum bucket tooth height	2685 mm
(I) Maximum dump height	1818 mm
(J) Maximum depth of vertical wall which can be excavated	1383 mm
(K) Maximum digging depth	1820 mm



**EXCAVATOR SPECIFICATIONS (CONT'D)**

**Lift Capacity (Object Handling Applications Excluded)**

- All dimensions are given in mm.
- Where applicable, specification conform to SAE or ISO standards and are subject to change without notice.

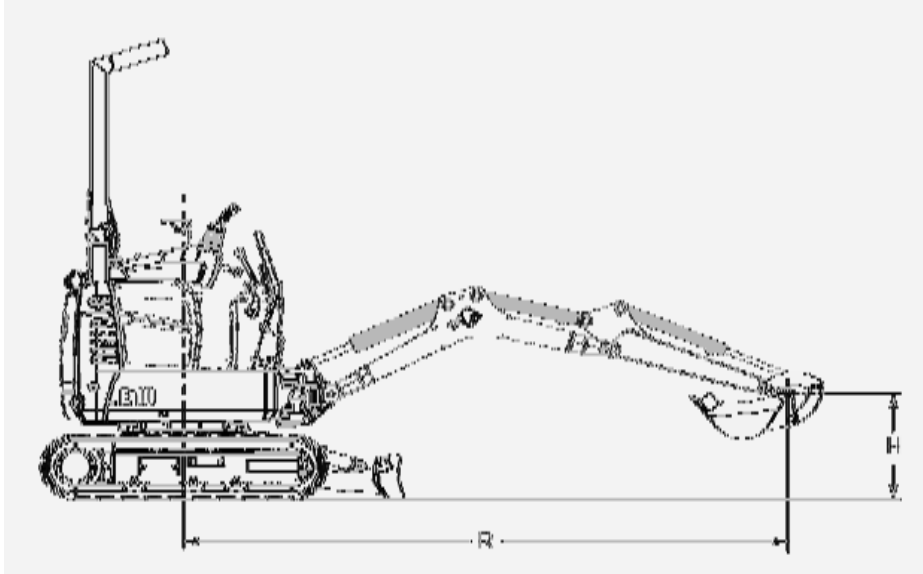

<b>Rated lift capacity over blade, blade down</b>			
<b>Lift point height [H] (mm)</b>	<b>Maximum radius [R] (mm)</b>	<b>Lift at max. radius (kg)</b>	<b>Lift at 2000 mm radius</b>
2000	2030	319*	319*
1000	2620	275*	345*
Ground	2640	239*	404*
-1000	2030	210*	214*
<b>Rated lift capacity over blade, blade up</b>			
<b>Lift point height [H] (mm)</b>	<b>Maximum radius [R] (mm)</b>	<b>Lift at max. radius (kg)</b>	<b>Lift at 2000 mm radius</b>
2000	2030	192	206
1000	2620	121	197
Ground	2640	116	174
-1000	2030	171	171
<b>Rated lift capacity over side, blade up, undercarriage retracted</b>			
<b>Lift point height [H] (mm)</b>	<b>Maximum radius [R] (mm)</b>	<b>Lift at max. radius (kg)</b>	<b>Lift at 2000 mm radius</b>
2000	2030	90	94
1000	2620	54	92
Ground	2640	48	78
-1000	2030	73	75
<b>Rated lift capacity over side, blade up, undercarriage expanded</b>			
<b>Lift point height [H] (mm)</b>	<b>Maximum radius [R] (mm)</b>	<b>Lift at max. radius (kg)</b>	<b>Lift at 2000 mm radius</b>
2000	2030	200	211
1000	2620	129	204
Ground	2640	119	181
-1000	2030	174	184

\* Rated hydraulic lift capacity with 400 mm bucket



## EXCAVATOR SPECIFICATIONS (CONT'D)

### Performance

Digging force, dipperstick (ISO 6015)	5550 N
Digging force, bucket (ISO 6015)	8294 N
Drawbar pull (theoretical at 90% efficiency)	9905 N
Ground pressure	29.7 kPa

### Function Time

Boom raise time	4.2 s
Boom lower time	4.2 s
Bucket curl time	3.2 s
Bucket dump time	2.3 s
Dipperstick retract time	3.9 s
Dipperstick extend time	2.6 s
Boom swing left time	4.1 s
Boom swing right time	3.2 s
Blade raise time	1.7 s
Blade lower time	1.2 s
Slew rate	9 RPM
Undercarriage expand time	5.0 s
Undercarriage retract time	3.5 s

### Weights

Operating weight with TOPS canopy , rubber tracks, 400 mm bucket	1176 kg
------------------------------------------------------------------	---------

### Controls

Engine	Hand levers on right hand side
Starting	Key-type starter switch and shutdown
Blade	Right hand lever
Boom swing	Right foot pedal
Hydraulics	Two levers control boom, bucket, dipperstick and upper structure slew
Auxiliary hydraulics	Left-hand foot pedal
Upper structure slew brake	Hydraulic lock on motor
Holding brake for upper structure slew	Pin lock
Steering	Direction and speed controlled by two hand levers



**EXCAVATOR SPECIFICATIONS (CONT'D)**

**Engine**

Make / Model	Kubota / D722-E2B-BCZ-6 (TIER2)
Fuel	Diesel
Cooling	Liquid
Maximum power at 2000 RPM (ISO 9249)	7.4 kW
Maximum governed speed	2000 RPM
High idle speed	2370 RPM
Low idle speed	1300 – 1400 RPM
Torque at 1600 RPM (SAE Net)	39.1 Nm
Number of cylinders	3
Displacement	0.72 l
Bore	67 mm
Stroke	68 mm
Lubrication	Forced lubrication with cartridge type filter
Crankcase ventilation	Closed breathing
Air filter	Dual dry replaceable paper cartridge
Ignition	Compression ignited (diesel)
Starting aid	Intake air heater

**Electrical**

Alternator	12 V - 40 A - open frame with internal regulator
Battery	12 V - 530 cold cranking A at -18 °C - 75 min reserve capacity
Starter	12 V - reduction on drive - 1,4 kW

**Hydraulic System**

Pump Type	Double gear pump
Pump capacity	2 * 10 l/min @ 2000 RPM
System relief pressure for implement circuits	184 - 192 bar
System relief pressure for travel circuits	184 - 192 bar
System relief pressure for auxiliary circuits	184 - 192 bar
System relief pressure for slew circuits	84 bar
Main hydraulic filter bypass	1.72 bar
Boom port relief base and rod end	232 bar
Control valve	Nine-spool parallel type, open centre
Hydraulic filter	Full-flow replaceable
Fluid lines	SAE standard tubelines, hoses, and fittings
Auxiliary flow	20 l/min



## EXCAVATOR SPECIFICATIONS (CONT'D)

### Hydraulic Cylinders

Boom cylinder	Cushion up
Boom cylinder bore	63.5
Boom cylinder rod	31.8
Boom cylinder stroke	312.4
Dipperstick cylinder	Cushion
Dipperstick cylinder bore	50.8
Dipperstick cylinder rod	31.8
Dipperstick cylinder stroke	325.6
Bucket cylinder	No cushion
Bucket cylinder bore	44.5
Bucket cylinder rod	25.4
Bucket cylinder stroke	385.1
Boom swing cylinder	No cushion
Boom swing cylinder bore	57.1
Boom swing cylinder rod	31.8
Boom swing cylinder stroke	274.6
Blade cylinder	No cushion
Blade cylinder bore	50.8
Blade cylinder rod	31.8
Blade cylinder stroke	96.8
Undercarriage cylinder	No cushion
Undercarriage cylinder bore	44.5
Undercarriage cylinder rod	25.4
Undercarriage cylinder stroke	400.1

### Drive System

Travel motor	Each track is driven by hydrostatic axial piston motor
Drive reduction	Two-stage planetary gear reduction 18:53:1

### Traction

Track width, rubber, standard	180 mm
Track adjusters	Grease type
Track type, standard	Half-pitch, rubber
Travel speed	2,1 km/h
Travel speed, high range (option)	3,1 km/h
Undercarriage	Crawler-type tractor design with reinforced box-section track roller frame and sealed track rollers
Number of track rollers per side	3
Gradeability travelling down or backing up slopes	30°
Gradeability travelling on side slopes	15°
Gradeability travelling up side slopes	15°



**EXCAVATOR SPECIFICATIONS (CONT'D)**

**Fluid Capacities**

Cooling system	3.0 l
Engine lubrication plus oil filter	3.5 l
Fuel reservoir	16.0 l
Hydraulic reservoir	2.6 l
Hydraulic system with bucket and dipper cylinder retracted, bucket on the ground, and blade down	10.1 l
Travel motor (each)	0,5 l

**Instrumentation**

- Air intake heater indicator
- Charging system indicator
- Engine oil pressure indicator
- Engine temperature indicator
- Fuel gauge
- Hour meter
- Two speed range indicator

**Fluid Specifications**

Engine coolant	Polypropylene glycol/water mix (53% - 47%) with freeze protection to -37°C 5 l can - 6904844A, 25 l container - 6904844B, 209 l drum - 6904844C, 1000 l tank - 6904844D
Engine oil	Oil must meet API Service Classification of CD, CE, CF4, CG4, or better. Recommended SAE viscosity number for anticipated temperature range.  * Can be used only when available with appropriate diesel rating. For synthetic oil use the recommendation from the oil manufacturer.
Hydraulic fluid	Bobcat Superior SH, 5 l can - 6904842A, 25 l container - 6904842B, 209 l drum 6904842C, 1000 l tank 6904842D Bobcat Bio Hydraulic, 5 l can - 6904843A, 25 l container - 6904843B, 209 l drum 6904843C, 1000 l tank 6904843D



**EXCAVATOR SPECIFICATIONS (CONT'D)**

**Environmental**

Noise level LpA (EU Directive 2000/14/EC)	— dB(A)	Noise level LWA (EU Directive 2000/14/EC)	91.8 dB(A)
Operator position noise level (EU Directive 2006/42/EC)	82.0 dB(A)	Uncertainties	+2.5/-0 dB(A)
Whole body vibration (ISO 2631-1) (limit 0,5 m/s <sup>2</sup> )	0.68 m/s <sup>2</sup>	Uncertainties	0.34 m/s <sup>2</sup>
Hand-arm vibration (ISO 5349-1) (limit 2,5 m/s <sup>2</sup> )	0.7 m/s <sup>2</sup>	Uncertainties	— m/s <sup>2</sup>

**Temperature Range**

Operation and storage	-17°C - +43°C
-----------------------	---------------



## WARRANTY

WARRANTY ..... 106





**Bobcat®**



WARRANTY

# WARRANTY

## BOBCAT EXCAVATORS

DOOSAN TRADING LIMITED warrants to its authorised dealers who in turn warrant to the end-user / owner, that each new Bobcat excavator will be free from proven defects in material and workmanship for twelve months from the date of delivery to the end-user / owner or 2000 hours of machine usage, whichever occurs first, with the exception of tracks which are covered for the same initial period on a pro-rated basis based on the remaining depth of the track at the time any defect is discovered,

During the warranty period, the authorised selling Bobcat dealer shall repair or replace, at DOOSAN TRADING LIMITED's option, without charge for parts, labour and travel time of mechanics, any part of the Bobcat product which fails because of defects in material and workmanship. The end-user / owner shall provide the authorised dealer with prompt written notice of the defect and allow reasonable time for replacement or repair. DOOSAN TRADING LIMITED may, at its option, request failed parts to be returned to the factory. Transportation of the Bobcat product to the authorised Bobcat Excavator dealer for warranty work is the responsibility of the end-user / owner.

Service schedules must be adhered to, documented and genuine parts / lubricants must be used. The warranty does not cover oils and lubricants, coolant fluids, filter elements, tune-up parts, bulbs, fuses, ignition system parts (glow plugs, fuel injection pumps, injectors), alternator fan belts, drive belts and other high-wear items. Pins and bushings are considered to be normal consumable items and are not warranted.

The warranty does not cover damages resulting from abuse, accidents, alterations, use of the Bobcat product with any bucket or attachment not approved by Bobcat, air flow obstructions, or failure to maintain or use the Bobcat product according to the instructions applicable to it.

DOOSAN TRADING LIMITED EXCLUDES OTHER CONDITIONS, WARRANTIES OR REPRESENTATIONS OF ALL KINDS, EXPRESSED OR IMPLIED, STATUTORY OR OTHERWISE (EXCEPT THAT OF TITLE) INCLUDING ALL IMPLIED WARRANTIES AND CONDITIONS RELATING TO MERCHANTABILITY, SATISFACTORY QUALITY AND FITNESS FOR A PARTICULAR PURPOSE.

CORRECTIONS BY DOOSAN TRADING LIMITED OF NONCONFORMITIES WHETHER PATENT OR LATENT, IN THE MANNER AND FOR THE TIME PERIOD PROVIDED ABOVE, SHALL CONSTITUTE FULFILMENT OF ALL LIABILITIES OF DOOSAN TRADING LIMITED FOR SUCH NONCONFORMITIES, WHETHER BASED ON CONTRACT, WARRANTY, TORT, NEGLIGENCE, INDEMNITY, STRICT LIABILITY OR OTHERWISE WITH RESPECT TO OR ARISING OUT OF SUCH PRODUCT.

THE REMEDIES OF THE END-USER / OWNER SET FORTH UNDER THE PROVISIONS OF THE WARRANTY OUTLINED ABOVE ARE EXCLUSIVE AND THE TOTAL LIABILITY OF DOOSAN TRADING LIMITED INCLUDING ANY HOLDING, SUBSIDIARY, ASSOCIATED OR AFFILIATED COMPANY OR DISTRIBUTOR WITH RESPECT TO THIS SALE OR THE PRODUCT AND SERVICE FURNISHED HEREUNDER IN CONNECTION WITH THE PERFORMANCE OR BREACH THEREOF, OR FROM DELIVERY, INSTALLATION, REPAIR OR TECHNICAL DIRECTION COVERED BY OR FURNISHED UNDER THIS SALE, WHETHER BASED ON CONTRACT, WARRANTY, TORT, NEGLIGENCE, INDEMNITY, STRICT LIABILITY OR OTHERWISE SHALL NOT EXCEED THE PURCHASE PRICE OF THE PRODUCT UPON WHICH SUCH LIABILITY IS BASED.

DOOSAN TRADING LIMITED INCLUDING ANY HOLDING, SUBSIDIARY, ASSOCIATED OR AFFILIATED COMPANY AND DISTRIBUTOR SHALL IN NO EVENT BE LIABLE TO THE END-USER / OWNER, ANY SUCCESSORS IN INTEREST OR ANY BENEFICIARY OR ASSIGNEE RELATING TO THIS SALE FOR ANY CONSEQUENTIAL, INCIDENTAL, INDIRECT, SPECIAL OR PUNITIVE DAMAGES ARISING OUT OF THIS SALE OR BY ANY BREACH THEREOF, OR ANY DEFECT IN, OR FAILURE OF, OR MALFUNCTION OF THE PRODUCT UNDER THIS SALE, WHETHER BASED UPON LOSS OF USE, LOST PROFITS OR REVENUE, INTEREST, LOST GOODWILL, WORK STOPPAGE, IMPAIRMENT OF OTHER GOODS, LOSS BY REASON OF SHUTDOWN OR NON-OPERATION, INCREASED EXPENSES OF OPERATION OR CLAIMS OF USER OR CUSTOMERS OF THE USER FOR SERVICE INTERRUPTION WHETHER OR NOT SUCH LOSS OR DAMAGE IS BASED ON CONTRACT, WARRANTY, TORT, NEGLIGENCE, INDEMNITY, STRICT LIABILITY OR OTHERWISE.



**Bobcat**  
**Bobcat**

4700003-EN (10-09)

Printed in Belgium



**Bobcat®**



**ALPHABETICAL INDEX**

AIR CLEANER . . . . .	67	STARTING THE ENGINE . . . . .	46
ALTERNATOR BELT . . . . .	74	STEERING LEVERS . . . . .	36
BLADE CONTROL . . . . .	41	TAILGATE . . . . .	34
BLADE EXTENSION . . . . .	88	TAILGATE . . . . .	66
BOBCAT COMPANY IS		TRACK FRAME EXPANSION . . . . .	42
ISO 9001 CERTIFIED . . . . .	10	TRACK ROLLER AND IDLER	
BOBCAT EXCAVATOR IDENTIFICATION .	14	LUBRICATION . . . . .	89
BUCKETS AND ATTACHMENTS . . . . .	48	TRACK TENSION . . . . .	85
CONTROL CONSOLE LOCKOUTS . . . . .	83	TRANSPORTING THE EXCAVATOR . . . . .	57
CONTROL LOCKOUT CONSOLES . . . . .	33	UPPERSTRUCTURE SLEW LOCK . . . . .	43
COOLING SYSTEM . . . . .	72	WARRANTY . . . . .	106
DAILY INSPECTION . . . . .	44		
DECLARATION OF CONFORMITY . . . . .	8		
DELIVERY REPORT . . . . .	13		
DRIVE MOTOR . . . . .	87		
ELECTRICAL SYSTEM . . . . .	76		
ENGINE LUBRICATION SYSTEM . . . . .	70		
ENGINE SPEED CONTROL . . . . .	33		
EXCAVATOR SPECIFICATIONS . . . . .	96		
EXCAVATOR STORAGE AND RETURN TO			
SERVICE . . . . .	93		
FEATURES, ACCESSORIES, AND			
ATTACHMENTS . . . . .	15		
FIRE PREVENTION . . . . .	22		
FUEL SYSTEM . . . . .	69		
HYDRAULIC CONTROLS . . . . .	38		
HYDRAULIC SYSTEM . . . . .	80		
INSTRUMENTS AND CONTROLS . . . . .	32		
LIFTING THE EXCAVATOR . . . . .	56		
LUBRICANTS AND FLUIDS . . . . .	11		
LUBRICATING THE EXCAVATOR . . . . .	89		
MACHINE SIGNS (DECALS) . . . . .	25		
OPERATING PROCEDURE . . . . .	49		
OPERATOR CANOPY (TOPS) . . . . .	16		
OPERATOR CANOPY . . . . .	35		
PARKING THE EXCAVATOR . . . . .	56		
PRE-STARTING PROCEDURE . . . . .	45		
PUBLICATIONS AND TRAINING			
RESOURCES . . . . .	24		
REGULAR MAINTENANCE ITEMS . . . . .	10		
SAFETY INSTRUCTIONS . . . . .	20		
SAFETY SIGNS . . . . .	24		
SEAT BELT . . . . .	68		
SERIAL NUMBER LOCATIONS . . . . .	12		
SERVICE SCHEDULE . . . . .	64		
SPARK ARRESTER MUFFLER . . . . .	84		



**Bobcat®**