



**Bobcat**®

EN

---

# Operation & Maintenance Manual T870 Compact Track Loader

---

S/N B3BZ11001 & Above

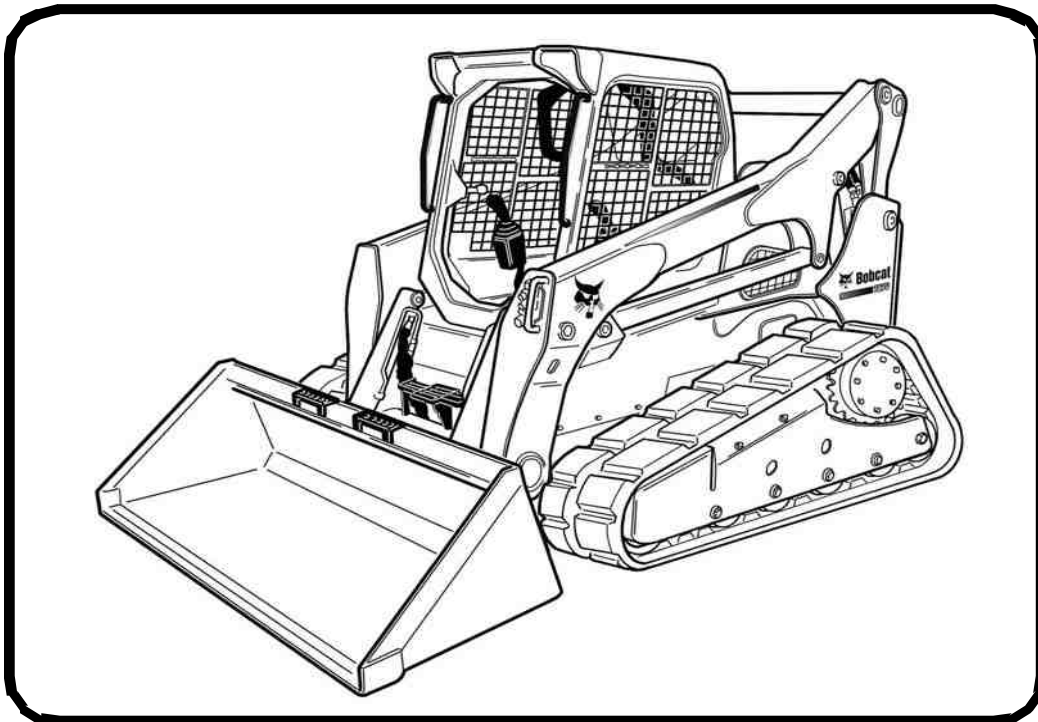

EQUIPPED WITH  
BOBCAT INTERLOCK  
CONTROL SYSTEM (BICS™)

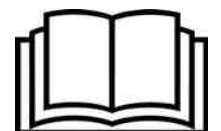

# OPERATOR SAFETY WARNINGS

## WARNING

Operator must have instructions before operating the machine. Untrained operators can cause injury or death.

W-2001-0502

**CORRECT**

P-90216

**Safety Alert Symbol:** This symbol with a warning statement, means: "Warning, be alert! Your safety is involved!" Carefully read the message that follows.

**Never use the loader without instructions. See machine signs (decals), Operation & Maintenance Manual, and Operator's Handbook.**

**CORRECT**

NA1254

**CORRECT**

NA1720

**WRONG**

NA1723

**Always use the seat bar and fasten seat belt snugly.**

**Always keep feet on the foot pedals or footrests when operating loader.**

**Never use loader without operator cab with ROPS and FOPS approval. Fasten your seat belt.**

**Never use loader as man lift or elevating device for personnel.**

**WRONG**

NA1724

**WRONG**

NA1721

**WRONG**

NA1716

**Do not use loader in atmosphere with explosive dust, explosive gas, or where exhaust can contact flammable material.**

**Never carry riders.**

**Keep bystanders away from work area.**

**Always carry bucket or attachments as low as possible.**

**Do not travel or turn with lift arms up.**

**Load, unload, and turn on flat level ground.**

**WRONG**

NA1718

**WRONG**

NA1719

**WRONG**

NA1717

**Never exceed Rated Operating Capacity.**

**Never leave loader with engine running or with lift arms up.**

**To park, engage parking brake and put attachment flat on the ground.**

**Never modify equipment.**

**Use only attachments approved by Bobcat Company for this model loader.**

## SAFETY EQUIPMENT

The Bobcat® loader must be equipped with safety items necessary for each job. Ask your Bobcat dealer for information on the availability and safe use of attachments and accessories.

1. **SEAT BELT:** Check belt fasteners and check for damaged webbing or buckle.
2. **SEAT BAR:** When up, it must lock the loader controls.
3. **OPERATOR CAB (ROPS and FOPS):** It must be on the loader with all fasteners tight.
4. **OPERATOR'S HANDBOOK:** Must be in the cab.
5. **SAFETY SIGNS (DECALS):** Replace if damaged.
6. **SAFETY TREADS:** Replace if damaged.
7. **GRAB HANDLES:** Replace if damaged.
8. **LIFT ARM SUPPORT DEVICE:** Replace if damaged.
9. **PARKING BRAKE**
10. **BOBCAT INTERLOCK CONTROL SYSTEM (BICS)**



## CONTENTS

FOREWORD .....	2
SAFETY AND TRAINING RESOURCES .....	13
OPERATING INSTRUCTIONS .....	32
PREVENTIVE MAINTENANCE .....	119
SYSTEM SETUP AND ANALYSIS .....	189
SPECIFICATIONS .....	212
WARRANTY .....	219
ALPHABETICAL INDEX .....	222

### REFERENCE INFORMATION

Write the correct information for YOUR Bobcat loader in the spaces below. Always use these numbers when referring to your Bobcat loader.

Loader Serial Number \_\_\_\_\_  
Engine Serial Number \_\_\_\_\_

NOTES:

\_\_\_\_\_  
\_\_\_\_\_  
\_\_\_\_\_

YOUR BOBCAT DEALER:

ADDRESS:

PHONE:

\_\_\_\_\_



Bobcat Company  
P.O. Box 128  
Gwinner, ND 58040-0128  
UNITED STATES OF AMERICA

Doosan Bobcat EMEA s.r.o.  
U Kodetky 1978  
26312 Dobris  
CZECH REPUBLIC



## FOREWORD

This Operation & Maintenance Manual was written to give the owner / operator instructions on the safe operation and maintenance of the Bobcat loader. **READ AND UNDERSTAND THIS OPERATION & MAINTENANCE MANUAL BEFORE OPERATING YOUR BOBCAT LOADER.** If you have any questions, see your Bobcat dealer. This manual may illustrate options and accessories not installed on your loader.

DECLARATION OF CONFORMITY .....	3
BOBCAT COMPANY IS ISO 9001 CERTIFIED .....	5
REGULAR MAINTENANCE ITEMS .....	5
Fluids, Lubricants And Fuel .....	6
SERIAL NUMBER LOCATIONS .....	7
Loader Serial Number .....	7
Engine Serial Number .....	7
DELIVERY REPORT .....	7
LOADER IDENTIFICATION .....	8
FEATURES, ACCESSORIES, AND ATTACHMENTS .....	9
Standard Items .....	9
Options And Accessories .....	9
Buckets Available .....	10
Attachments .....	10
High-Flow Attachments .....	10
Special Applications Kit .....	11
Special Applications Kit Inspection And Maintenance .....	11
Forestry Door And Window Kit .....	12
Forestry Door And Window Kit Inspection And Maintenance .....	12



**DECLARATION OF CONFORMITY**

**Contents of EC Declaration of Conformity**

This information is provided in the operators manual to comply with clause 1.7.4.2(c) of Annex I of Machinery Directive 2006/42/EC.

The official EC Declaration of Conformity is supplied in a separate document.

<p><b>Manufacturer</b></p>  <p><b>Bobcat</b></p> <p>Bobcat Company World Headquarters 250 East Beaton Drive West Fargo, ND 58078-6000 UNITED STATES OF AMERICA</p>	<p><b>Directive 2000/14/EC: Noise Emission in the Environment by Equipment For Use Outdoors</b></p> <p><b>Notified Body</b> Technical and Test Institute for Construction Prague, Czech Republic Notified Body Number: 1020</p> <p><b>EC Certificate No.</b> 1020-090-022395</p>				
<p><b>Technical Documentation</b> Homologation Manager Doosan Bobcat Engineering s.r.o. U Kodetky 1978 26312 Dobris CZECH REPUBLIC</p>	<p><b>Conformity Assessment Procedure(s)</b> 2000/14/EC, Annex VIII, Full Quality Assurance</p> <p><b>Sound Power Levels [Lw(A)]</b></p> <table border="0"> <tr> <td>Measured Sound Power</td> <td style="text-align: right;"><b>103 dBA</b></td> </tr> <tr> <td>Guaranteed Sound Power</td> <td style="text-align: right;"><b>104 dBA</b></td> </tr> </table>	Measured Sound Power	<b>103 dBA</b>	Guaranteed Sound Power	<b>104 dBA</b>
Measured Sound Power	<b>103 dBA</b>				
Guaranteed Sound Power	<b>104 dBA</b>				
<p><b>Description of Equipment</b> Type of Equipment: Crawler Loader Model Name: T870 Model Code: B3BZ Lot Series: 11001</p> <p>Engine Manufacturer: Bobcat Company Engine Model: D34P DL03-LEL01 Engine Power: 74,6 kW @ 2400 RPM</p>	<p><b>Equipment conforms to CE Directive(s) Listed Below</b> 2006/42/EC: Machinery Directive 2014/30/EU: Electromagnetic Compatibility Directive</p>				
<p><b>Declaration of Conformance</b> This equipment conforms to the requirements specified in all the EC Directives listed in this declaration.</p>					
<p><b>Effective From:</b>  20 April 2016</p>					

**DECLARATION OF CONFORMITY (CONT'D)**



Homologation Manager  
Doosan Bobcat Engineering s.r.o.  
U Kodetky 1978  
26312 Dobris  
Czech Republic

**Declaration of conformity with Article 14 of Regulation (EU) No 517/2014 of the European Parliament and of the Council**

We Doosan Bobcat EMEA s.r.o. with VAT number CZ26489201, acting in its capacity as EU only representative for the import of goods from Doosan Infracore Co., Ltd with its address at Doosan Tower, 275, Jangchungdan-ro, Jung-gu, Seoul, 100-730, Korea, declare under our sole responsibility that when placing on the market pre-charged equipment, which we import to or manufacture in the Union, the hydrofluorocarbons contained in that equipment are accounted for within the quota system referred to in Chapter IV of Regulation (EU) No 517/2014 as:

A. we hold authorisation(s) issued in accordance with Article 18(2) of Regulation (EU) No 517/2014 and registered in the registry referred to in Article 17 of that Regulation, at the time of release for free circulation to use the quota of a producer or importer of hydrofluorocarbons subject to Article 15 of Regulation (EU) No 517/2014 that cover(s) the quantity of hydrofluorocarbons contained in the equipment.

B. *[for importers of equipment only]* the hydrofluorocarbons contained in the equipment have been placed on the market in the Union, subsequently exported and charged into the equipment outside the Union, and the undertaking that placed the hydrofluorocarbons on the market made a declaration stating that the quantity of hydrofluorocarbons has been or will be reported as placed on the market in the Union and that it has not been and will not be reported as direct supply for export in the meaning of Article 15(2)(c) of Regulation (EU) No 517/2014 pursuant to Article 19 of Regulation (EU) No 517/2014 and Section 5C of the Annex to Commission Implementing Regulation (EU) No 1191/2014 (2).

C. *[for equipment manufactured in the Union only]* the hydrofluorocarbons charged into the equipment were placed on the market by a producer or importer of hydrofluorocarbons subject to Article 15 of Regulation (EU) No 517/2014.

Dobroslav Rak

30th January, 2017

Doosan Bobcat EMEA s.r.o. | Identification No. 264 89 201 | Prague Commercial Register Section C, Entry 85459





**BOBCAT COMPANY IS ISO 9001 CERTIFIED**









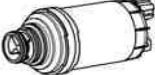

**ISO 9001** is an international standard that specifies requirements for a quality management system that controls the processes and procedures which we use to design, develop, manufacture, and distribute Bobcat products.

British Standards Institute (**BSI**) is the Certified Registrar Bobcat Company chose to assess the company's compliance with the ISO 9001 at Bobcat's manufacturing facilities in Gwinner, North Dakota (U.S.A.), Pontchâteau (France), and the Bobcat corporate offices (Gwinner, Bismarck, and West Fargo) in North Dakota. **TÜV Rheinland** is the Certified Registrar Bobcat Company chose to assess the company's compliance with the ISO 9001 at Bobcat's manufacturing facility in Dobris (Czech Republic). Only certified assessors, like BSI and TÜV Rheinland, can grant registrations.

ISO 9001 means that as a company we say what we do and do what we say. In other words, we have established procedures and policies, and we provide evidence that the procedures and policies are followed.

**REGULAR MAINTENANCE ITEMS**

	<b>ENGINE OIL FILTER</b> 7012303		<b>BATTERY</b> 7269857
	<b>FUEL FILTER</b> 7023589		<b>HYDRAULIC FILTER</b> 7248874
	<b>AIR FILTER, Outer</b> 7286652		<b>HYDRAULIC CHARGE FILTER</b> 6686926
	<b>AIR FILTER, Inner</b> 7010031		<b>HYDRAULIC FILL / BREATHER CAP</b> 6727475

**NOTE: Always verify Part Numbers with your Bobcat dealer.**



**REGULAR MAINTENANCE ITEMS (CONT'D)**

**Fluids, Lubricants And Fuel**

The fluids, lubricants and fuel described below are those used in the factory and apply to operating conditions in European temperate climate areas. Please see your Bobcat dealer for requirements in other climate areas.

Read and understand the preventive maintenance required before adding or replacing any fluids or lubricants. (See PREVENTIVE MAINTENANCE on Page 119.)

<b>ENGINE SYSTEMS</b>				
<b>Machine Components</b>	<b>Fluids And Lubricants</b>	<b>T° Range</b>	<b>Packaging**</b>	<b>Part Number</b>
Engine	- Bobcat Engine Power SAE 10W30 CJ4 / ACEA E9	-25°C - +30°C	A, B, C, D	6987818*
	- Bobcat Engine Power SAE 15W40 CJ4 / ACEA E9	-20°C - +40°C	A, B, C, D	6987819
Cooling Circuit	- Bobcat PG Coolant Concentrated	-36°C	B, C, D	6987813*
	- Bobcat PG Coolant 4 Seasons	-36°C	A, B, C, D	6987793
DEF / AdBlue®	- DEF / AdBlue®: Air1 that meets ISO 22241-1 or AUS32 that meets DIN70070 (See DIESEL EXHAUST FLUID (DEF) / ADBLUE® SYSTEM on Page 147.)	-	-	*
Fuel Tank	- High-quality diesel fuel that meets EN590 (See FUEL SYSTEM on Page 143.)	-	-	*

<b>HYDRAULIC / HYDROSTATIC SYSTEMS</b>				
<b>Machine Components</b>	<b>Fluids And Lubricants</b>	<b>T° Range</b>	<b>Packaging**</b>	<b>Part Number</b>
Hydraulic Fluid Tank	- Bobcat Superior SH Hydraulic / Hydrostatic	-35°C - +50°C	A, B, C, D	6987791*
	- Bobcat Biodegradable Hydraulic / Hydrostatic	-35°C - +50°C	A, B, C, D	6987792

<b>MECHANICAL SYSTEMS</b>				
<b>Machine Components</b>	<b>Fluids And Lubricants</b>	<b>Drop Point</b>	<b>Packaging**</b>	<b>Part Number</b>
All Mechanical Systems	- Bobcat Multipurpose Grease	From 260°C	E	6987888*
	- Bobcat Supreme HD Grease	From 280°C	E	6987889
	- Bobcat Extreme HP Grease	From 260°C	E	6987890

(\*) Factory Filled Fluids And Lubricants

(\*\*) Packaging Available:

A = 5 L Can

B = 25 L Container

C = 209 L Drum

D = 1000 L Tank

E = 400 g Tube



## SERIAL NUMBER LOCATIONS

Always use the serial number of the loader when requesting service information or when ordering parts. Early or later models (identification made by serial number) may use different parts, or there may be different procedures to follow when performing a specific service operation.

### Loader Serial Number

Figure 1

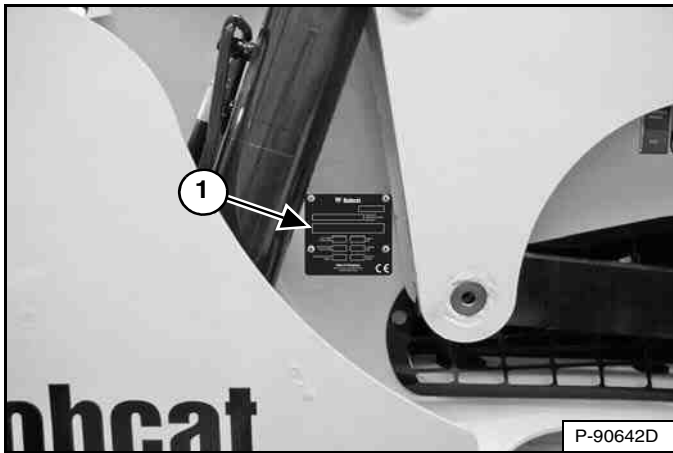

The loader serial number plate (Item 1) [Figure 1] is located on the outside of the loader frame.

### Engine Serial Number

Figure 2

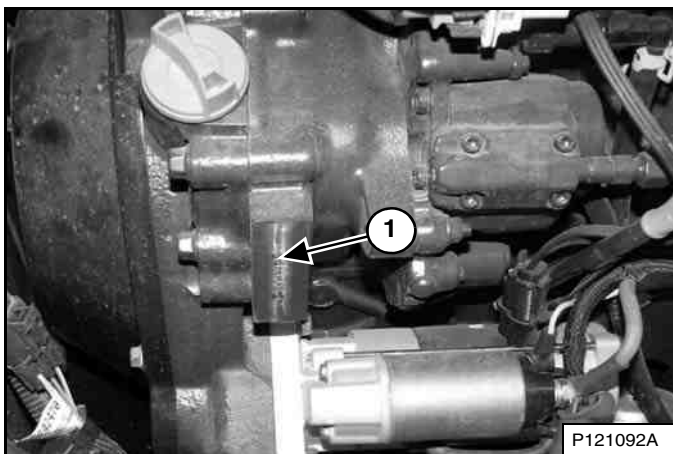

The engine serial number (Item 1) [Figure 2] is located on the side of the engine below the oil fill cap.

## DELIVERY REPORT

Figure 3

The delivery report [Figure 3] contains a list of items that must be explained or shown to the owner or operator by the dealer when the Bobcat loader is delivered.

The delivery report must be reviewed and signed by the owner or operator and the dealer.

**LOADER IDENTIFICATION**

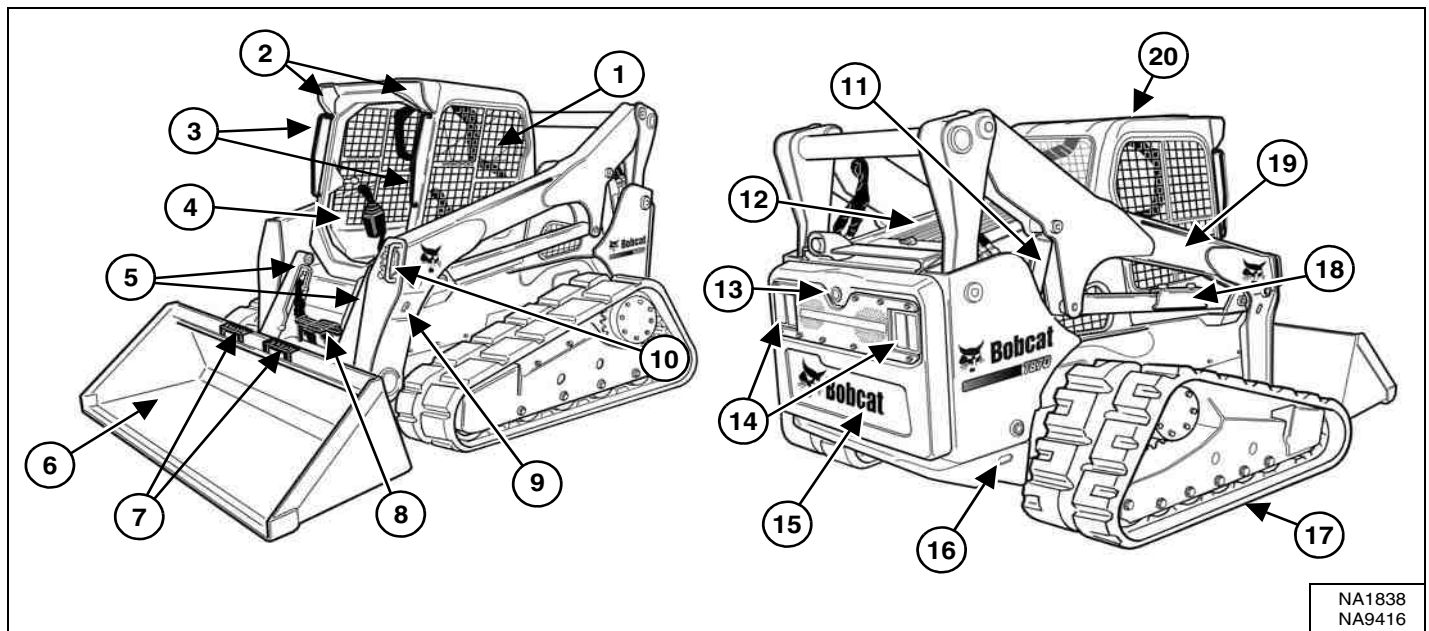

ITEM	DESCRIPTION	ITEM	DESCRIPTION
1	Operation & Maintenance Manual and Operator's Handbook	11	Lift Cylinder (Both Sides)
2	Front Lights	12	Rear Grille
3	Grab Handles	13	Back-up Alarm [C]
4	Operator Seat with Seat Belt and Seat Bar	14	Rear Work Lights and Taillights
5	Tilt Cylinders	15	Rear Door
6	Bucket [A]	16	Rear Tie-down (Both Sides) Front Tie-down located behind Bucket
7	Bucket Steps	17	Track
8	Step	18	Lift Arm Support Device
9	Alternate Front Tie-down (Both Sides)	19	Lift Arm
10	Front Auxiliary Quick Couplers	20	Operator Cab (ROPS and FOPS) [B]

[A] Bucket – Several different buckets and other attachments are available for the Bobcat loader.

[B] ROPS – Roll-Over Protective Structure per ISO 3471 and FOPS – Falling-Object Protective Structure per ISO 3449, Level I. Level II is available.

[C] Optional or Field Accessory, (Not Standard Equipment.)



## FEATURES, ACCESSORIES, AND ATTACHMENTS

### Standard Items

This model T870 Bobcat loader is equipped with the following standard items:

- 75 kW Bobcat Engine Turbo Stage IV Diesel Engine
- Access Covers
- Adjustable Suspension Seat
- Air Intake Heater (Automatically activated)
- Auto Idle
- Auxiliary Hydraulics: Variable Flow
- Bobcat Interlock Control System (BICS™)
- Bob-Tach®
- Cab (includes: rear and side windows and polycarbonate top window) ROPS and FOPS (Level I) Approved
- Cab Accessory Harness
- CE Certification
- Controls: Selectable Joystick Controls (SJC) (Selectable 'ISO' or 'H' Pattern Control)
- Deluxe Interior with Storage Compartments
- Engine / Hydraulic Systems Shutdown
- Front Horn
- Hydraulic Bucket Positioning (With On / Off Selection)
- Hydraulic Muffler
- Instrumentation: Hourmeter, Engine rpm, System Voltage; Engine Temperature and Fuel Gauges; Warning Lights
- Lift Arm Support Device
- Lights: Front and Rear
- Parking Brake
- Roller Suspension™ Undercarriage with 4 Rollers
- Seat Bar
- Seat Belt with 3-Point Restraint
- Security Locks (Tailgate and rear grille)
- Sound Reduction (Reduces noise at operator ear)
- Spark Arrester Device
- Tracks, Rubber – 450 mm (17.7 in)
- Two-Speed Travel

### Options And Accessories

Below is a list of some equipment available from your Bobcat loader dealer as Dealer and / or Factory Installed Accessories and Factory Installed Options. See your Bobcat dealer for other available options and accessories.

- Adjustable Air Ride Suspension Seat
- Air Conditioning
- Attachment Control Device (ACD) (7-Pin, 14-Pin)
- Automatic Ride Control
- Auxiliary Hydraulics Coupler Guard

### Options And Accessories (Cont'd)

- Back-up Alarm
- Bucket Shields
- Cab Door with Emergency Exit
- Cab Heater
- Cab Reseal Plug Kit
- Counterweight Kit
- Deluxe Instrumentation Panel with Keyless Start
- DeSOX Inhibit Switch Kit
- Dual Fuel Filter Kit
- Engine Compartment Seal Kit
- Extended Pedals
- Fire Extinguisher
- FOPS Kit (Level II)
- FOPS Window Kit
- Forestry Door and Window Kit
- Forestry Door Wiper
- Four-Way Flashers (Also adds Turn Signal function)
- Front and Rear Light Guards
- High-Flow Auxiliary Hydraulics
- Hose Guide
- Keyless Start
- Lift Kit (Four-Point, Single-Point)
- Lights Extension Kit for Wide Attachments
- Locking Diesel Exhaust Fluid (DEF) / AdBlue® Cap
- Locking Fuel Cap
- Maintenance Platform
- Power Bob-Tach®
- Radio
- Rear Auxiliary Hydraulics
- Rear Bumper Kit
- Rear Window Wiper
- Reversing Fan
- Road Kit
- Rotating Beacon
- Seat Belt – 3 in. Wide
- Side Lighting
- Special Applications Kit
- Strobe Light
- Tilt Cylinder Guard Kit
- Windows:
  - Externally Removable Rear Window
  - Polycarbonate Rear Window
  - Polycarbonate Side Windows

***Specifications subject to change without notice and standard items may vary.***



## FEATURES, ACCESSORIES, AND ATTACHMENTS (CONT'D)

These and other attachments are approved for use on this model loader. Do not use unapproved attachments. Attachments not manufactured by Bobcat may not be approved.

The versatile Bobcat loader quickly turns into a multijob machine with a tight-fit attachment hook-up ... from bucket to grapple to pallet fork to backhoe, and a variety of other attachments.

See your Bobcat dealer for information about approved attachments and attachment Operation & Maintenance Manuals.

Increase the versatility of your Bobcat loader with a variety of bucket styles and sizes.

### Buckets Available

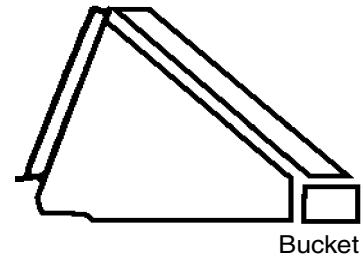

Many bucket styles, widths, and different capacities are available for a variety of different applications. They include Construction and Industrial, Low Profile, Fertiliser, and Snow, to name a few. See your Bobcat dealer for the correct bucket for your Bobcat loader and application.

### Attachments

- Angle Broom
- Auger
- Backhoe
- Blades — Dozer, Snow
- Breaker, Hydraulic
- Brush Saw
- Buckets
- Concrete Mixer
- Concrete Pump
- Drop Hammer
- Dumping Hopper
- Flail Cutter
- Grader
- Grapples — Industrial, Root
- Landplane
- Landscape Rake
- Mixing Bucket
- Packer Wheel
- Pallet Fork
- Rock Bucket
- Sand Cleaner
- Snow Pusher
- Snowblower
- Sod Layer
- Soil Conditioner
- Spreader
- Stabiliser, Rear
- Stump Grinder
- Tiller
- Tree Transplanter
- Trench Compactor
- Utility Frame
- Vibratory Roller
- Water Kit
- Wheel Saw
- X-Change™ Frame

### High-Flow Attachments

**The following attachments are approved for use on High-Flow machines. See your Bobcat dealer for an updated list of approved attachments.**

- Auger
- Brushcat™ Rotary Cutter
- Concrete Pump
- Flail Cutter
- Forestry Cutter
- Planer
- Rotary Grinder
- Snowblower
- Soil Conditioner
- Stump Grinder
- Tiller
- Wheel Saw
- Wood Chipper

**FEATURES, ACCESSORIES, AND ATTACHMENTS (CONT'D)**

**Special Applications Kit**



**AVOID INJURY OR DEATH**

Some attachment applications can cause flying debris or objects to enter front, top or rear cab openings. Install the Special Applications Kit to provide added operator protection in these applications.

W-2737-0508

**Special Applications Kit Inspection And Maintenance**

- Inspect for cracks or damage. Replace if required.
- Prerinse with water to remove gritty materials.
- Wash with a mild household detergent and warm water.
- Use a sponge or soft cloth. Rinse well with water and dry with a clean soft cloth or rubber squeegee.
- Do not use abrasive or highly alkaline cleaners.
- Do not clean with metal blades or scrapers.

**Figure 4**

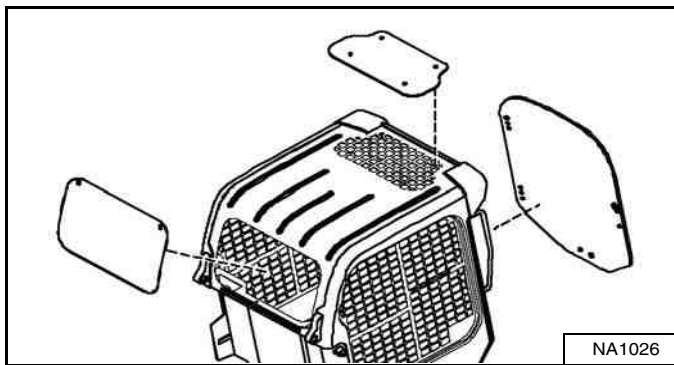

Available for special applications to restrict material from entering cab openings. Kit includes 12,7 mm (0.5 in) thick polycarbonate front door and polycarbonate rear window [Figure 4].

Polycarbonate top window (standard item) must be installed for special applications to restrict material from entering cab openings.

See your Bobcat dealer for availability.

**FEATURES, ACCESSORIES, AND ATTACHMENTS (CONT'D)**

**Forestry Door And Window Kit**

**Figure 5**

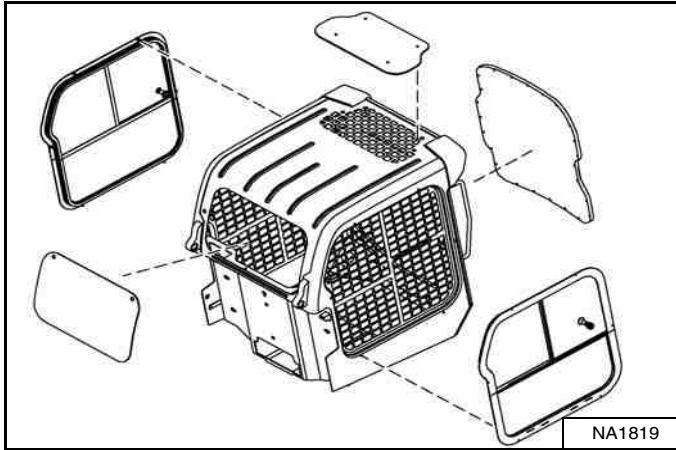

Available for special applications to prevent flying debris and objects from entering the cab. Kit includes 19,1 mm (0.75 in) thick laminated polycarbonate front door, polycarbonate side windows, and polycarbonate rear window **[Figure 5]**.

Polycarbonate top window (standard item) must be installed as part of the Forestry Door And Window Kit to restrict material from entering cab openings.

**Forestry Door And Window Kit Inspection And Maintenance**

- Inspect for cracks or damage. Replace if required.
- Order part number 7171104 if door frame is damaged and needs to be replaced.
- Order kit part number 7193293 if door polycarbonate is damaged and needs to be replaced.
- Prerinse with water to remove gritty materials.
- Wash with a mild household detergent and warm water.
- Use a sponge or soft cloth. Rinse well with water and dry with a clean soft cloth or rubber squeegee.
- Do not use abrasive or highly alkaline cleaners.
- Do not clean with metal blades or scrapers.

*Forestry Door Emergency Exit*

**Figure 6**

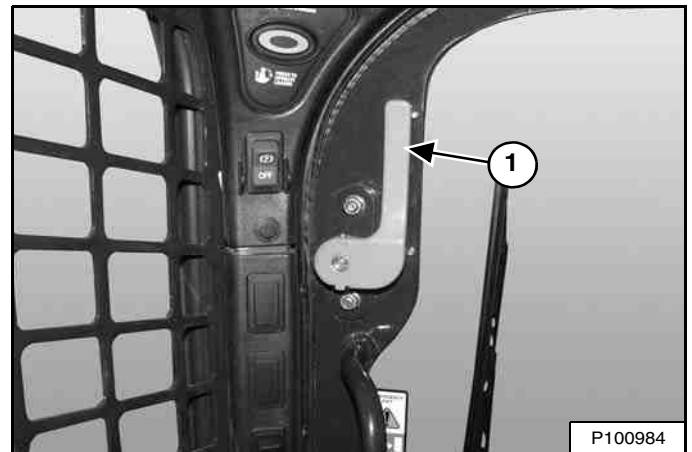

- Inspect both emergency exit levers (Item 1) **[Figure 6]**, linkages, and hardware for loose or damaged parts.
- Repair or replace if necessary.



## SAFETY AND TRAINING RESOURCES

SAFETY INSTRUCTIONS	14
Before Operation	14
Safe Operation Is The Operator's Responsibility	15
Safe Operation Needs A Qualified Operator	15
Avoid Silica Dust	16
FIRE PREVENTION	16
Maintenance	16
Operation	16
Electrical	16
Hydraulic System	17
Fueling	17
Starting	17
Spark Arrester Exhaust System	17
Welding And Grinding	17
Fire Extinguishers	17
PUBLICATIONS AND TRAINING RESOURCES	18
MACHINE SIGNS (DECALS)	19
Pictorial Only Safety Signs	21



## SAFETY INSTRUCTIONS

### Before Operation

Carefully follow the operating and maintenance instructions in this manual.

The Bobcat loader is highly manoeuvrable and compact. It is rugged and useful under a wide variety of conditions. This presents an operator with hazards associated with off motorway, rough terrain applications, common with Bobcat loader usage.

The Bobcat loader has an internal combustion engine with resultant heat and exhaust. All exhaust gases can kill or cause illness so use the Loader with adequate ventilation.

The dealer explains the capabilities and restrictions of the Bobcat loader and attachment for each application. The dealer demonstrates the safe operation according to Bobcat instructional materials, which are also available to operators. The dealer can also identify unsafe modifications or use of unapproved attachments. The attachments and buckets are designed for a Rated Operating Capacity (some have restricted lift heights). They are designed for secure fastening to the Bobcat loader. The user must check with the dealer, or Bobcat literature, to determine safe loads of materials of specified densities for the machine - attachment combination.

The following publications and training materials provide information on the safe use and maintenance of the Bobcat machine and attachments:

- The Delivery Report is used to assure that complete instructions have been given to the new owner and that the machine and attachment is in safe operating condition.
- The Operation & Maintenance Manual delivered with the machine or attachment gives operating information as well as routine maintenance and service procedures. It is a part of the machine and can be stored in a container provided on the machine. Replacement Operation & Maintenance Manuals can be ordered from your Bobcat dealer.
- Machine signs (decals) instruct on the safe operation and care of your Bobcat machine or attachment. The signs and their locations are shown in the Operation & Maintenance Manual. Replacement signs are available from your Bobcat dealer.
- An Operator's Handbook is fastened to the operator cab of the loader. Its brief instructions are convenient to the operator. See your Bobcat dealer for more information on translated versions.

The dealer and owner / operator review the recommended uses of the product when delivered. If the owner / operator will be using the machine for a different application(s) he or she must ask the dealer for recommendations on the new use.





## SAFETY INSTRUCTIONS (CONT'D)

### Safe Operation Is The Operator's Responsibility

Safety Alert Symbol

This symbol with a warning statement means:  
**"Warning, be alert! Your safety is involved!"**  
**Carefully read the message that follows.**

WARNING

**Operator must have instructions before operating the machine. Untrained operators can cause injury or death.**

W-2001-0502

IMPORTANT

**This notice identifies procedures which must be followed to avoid damage to the machine.**

I-2019-0284

DANGER

**The signal word DANGER on the machine and in the manuals indicates a hazardous situation which, if not avoided, will result in death or serious injury.**

D-1002-1107

WARNING

**The signal word WARNING on the machine and in the manuals indicates a potentially hazardous situation which, if not avoided, could result in death or serious injury.**

W-2044-1107

The Bobcat loader and attachment must be in good operating condition before use.

Check all of the items on the Bobcat Service Schedule Decal under the 8-10 hour column or as shown in the Operation & Maintenance Manual.

### Safe Operation Needs A Qualified Operator

For an operator to be qualified, he or she must not use drugs or alcoholic drinks which impair alertness or coordination while working. An operator who is taking prescription drugs must get medical advice to determine if he or she can safely operate a machine.

*A Qualified Operator Must Do The Following:*

*Understand the Written Instructions, Rules and Regulations*

- The written instructions from Bobcat Company include the Delivery Report, Operation & Maintenance Manual, Operator's Handbook and machine signs (decals).
- Check the rules and regulations at your location. The rules may include an employer's work safety requirements. For driving on public roads, the machine must be equipped as stipulated by the local regulations authorising operation on public roads in your specific country. Regulations may identify a hazard such as a utility line.

*Have Training with Actual Operation*

- Operator training must consist of a demonstration and verbal instruction. This training is given by your Bobcat dealer before the product is delivered.
- The new operator must start in an area without bystanders and use all the controls until he or she can operate the machine and attachment safely under all conditions of the work area. Always fasten seat belt before operating.

*Know the Work Conditions*

- Know the weight of the materials being handled. Avoid exceeding the Rated Operating Capacity (ROC) of the machine. Material which is very dense will be heavier than the same volume of less dense material. Reduce the size of the load if handling dense material.
- The operator must know any prohibited uses or work areas, for example, he or she needs to know about excessive slopes.
- Know the location of any underground lines.
- Wear tight fitting clothing. Always wear safety glasses when doing maintenance or service. Safety glasses, respiratory equipment, hearing protection or Special Applications Kits are required for some work. See your Bobcat dealer about Bobcat Safety Equipment for your model.

**SAFETY INSTRUCTIONS (CONT'D)**

**Avoid Silica Dust**



Cutting or drilling concrete containing sand or rock containing quartz may result in exposure to silica dust. Use a respirator, water spray or other means to control dust.

**FIRE PREVENTION**



**Maintenance**

The machine and some attachments have components that are at high temperatures under normal operating conditions. The primary source of high temperatures is the engine and exhaust system. The electrical system, if damaged or incorrectly maintained, can be a source of arcs or sparks.

Flammable debris (leaves, straw, etc.) must be removed regularly. If flammable debris is allowed to accumulate, it can cause a fire hazard. Clean often to avoid this accumulation. Flammable debris in the engine compartment is a potential fire hazard.

The operator's area, engine compartment and engine cooling system must be inspected every day and cleaned if necessary to prevent fire hazards and overheating.

All fuels, most lubricants and some coolants mixtures are flammable. Flammable fluids that are leaking or spilled onto hot surfaces or onto electrical components can cause a fire.

**Operation**

Do not use the machine where exhaust, arcs, sparks or hot components can contact flammable material, explosive dust or gases.

**Electrical**



Check all electrical wiring and connections for damage. Keep the battery terminals clean and tight. Repair or replace any damaged part or wires that are loose or frayed.

Battery gas can explode and cause serious injury. Use the procedure in the Operation & Maintenance Manual for connecting the battery and for jump starting. Do not jump start or charge a frozen or damaged battery. Keep any open flames or sparks away from batteries. Do not smoke in battery charging area.



## FIRE PREVENTION (CONT'D)

### Hydraulic System

Check hydraulic tubes, hoses and fittings for damage and leakage. Never use open flame or bare skin to check for leaks. Hydraulic tubes and hoses must be properly routed and have adequate support and secure clamps. Tighten or replace any parts that show leakage.

Always clean fluid spills. Do not use petrol or diesel fuel for cleaning parts. Use commercial non-flammable solvents.

### Fueling



Stop the engine and let it cool before adding fuel. No smoking! Do not refuel a machine near open flames or sparks. Fill the fuel tank outdoors.

Ultra Low Sulfur Diesel (ULSD) poses a greater static ignition hazard than earlier diesel formulations with higher Sulfur content. Avoid death or serious injury from fire or explosion. Consult with your fuel or fuel system supplier to ensure the delivery system is in compliance with fuelling standards for proper grounding and bonding practices.

### Starting

Do not use ether or starting fluids on any engine that has glow plugs or air intake heater. These starting aids can cause explosion and injure you or bystanders.

Use the procedure in the Operation & Maintenance Manual for connecting the battery and for jump starting.

### Spark Arrester Exhaust System

The spark arrester exhaust system is designed to control the emission of hot particles from the engine and exhaust system, but the muffler and the exhaust gases are still hot.

Check the spark arrester exhaust system regularly to make sure it is maintained and working properly. Use the procedure in the Operation & Maintenance Manual for cleaning the spark arrester muffler (if equipped).

### Welding And Grinding

Always clean the machine and attachment, disconnect the battery, and disconnect the wiring from the Bobcat controllers before welding. Cover rubber hoses, battery and all other flammable parts. Keep a fire extinguisher near the machine when welding.

Have good ventilation when grinding or welding painted parts. Wear dust mask when grinding painted parts. Toxic dust or gas can be produced.

Dust generated from repairing non-metallic parts such as hoods, fenders or covers can be flammable or explosive. Repair such components in a well ventilated area away from open flames or sparks.

### Fire Extinguishers

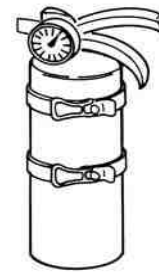

Know where fire extinguishers and first aid kits are located and how to use them. Inspect the fire extinguisher and service the fire extinguisher regularly. Obey the recommendations on the instructions plate.



**PUBLICATIONS AND TRAINING RESOURCES**

The following publications are also available for your Bobcat loader. You can order them from your Bobcat dealer.

For the latest information on Bobcat products and the Bobcat Company, visit our website at **Bobcat.com**



**OPERATION & MAINTENANCE MANUAL**

**7253831enGB**

Complete instructions on the correct operation and the routine maintenance of your Bobcat loader.



**SERVICE MANUAL**

**7248302enUS**

Complete maintenance instructions for your Bobcat loader.



**OPERATOR'S HANDBOOK**

**7254857enGB**

Gives basic operation instructions and safety warnings.



**MACHINE SIGNS (DECALS)**

Follow the instructions on all the Machine Signs (Decals) that are on the loader. Replace any damaged machine signs and be sure they are in the correct locations. Machine signs are available from your Bobcat loader dealer.

**1** 7168038

**2** 3-Point Restraint 7184346

**3** 7168082

**4** 7177707

**5** 7168143

**6** Back-up Alarm 7180087

**7** 7168037

**8** 7168034

**9** 7168040

**10** 7168033

**11** 7168039 (2)

**12** Single-Point Lift 7142142 (2)

**13** Four-Point Lift 7168020

**Inside Cab**

**7206487**

**7251372 (Earlier) 7300261 (Later) (Inside Fuse Access Panel) (Left Foot Area)**

**7200415**

**7170360**

**7169291**

**7168025**

**7168145**

**7168081**

**7168082**

**7168037**

**7173403 (Behind Bob-Tach)**

**7168034**

**7168040**

**7168033**

**7168031**

**6731994**

**6533898 (2)**

**7189824 (2)**

**7168040**

**7168020**

**7168040**

**7168020**

NA1838

19

T870 Operation & Maintenance Manual



**MACHINE SIGNS (DECALS) (CONT'D)**

Follow the instructions on all the Machine Signs (Decals) that are on the loader. Replace any damaged machine signs and be sure they are in the correct locations. Machine signs are available from your Bobcat loader dealer.

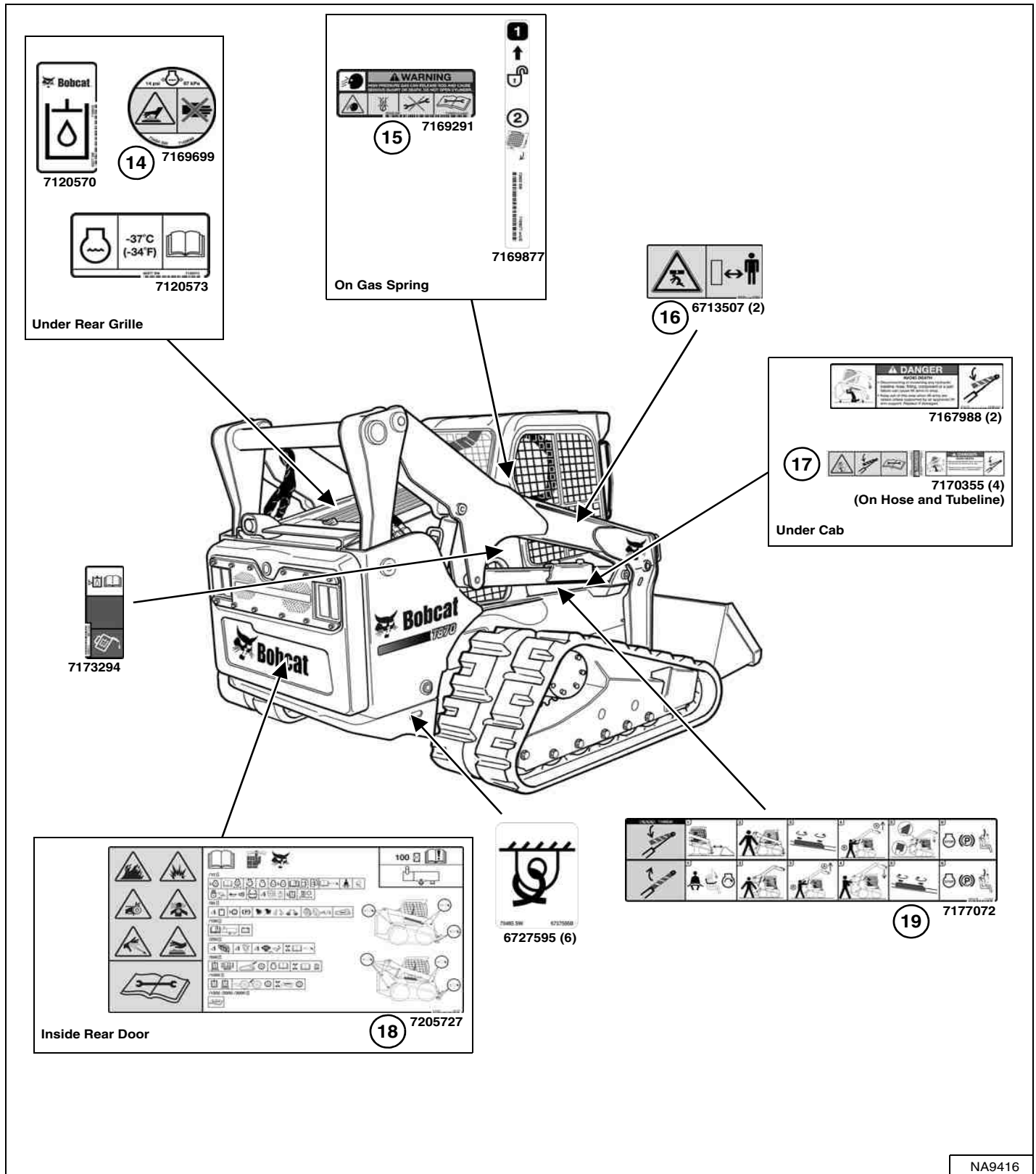

## MACHINE SIGNS (DECALS) (CONT'D)

### Pictorial Only Safety Signs

Safety signs are used to alert the equipment operator or maintenance person to hazards that may be encountered in the use and maintenance of the equipment. The location and description of the safety signs are detailed in this section. Please become familiarised with all safety signs installed on the machine / attachment.

*Vertical Configuration*

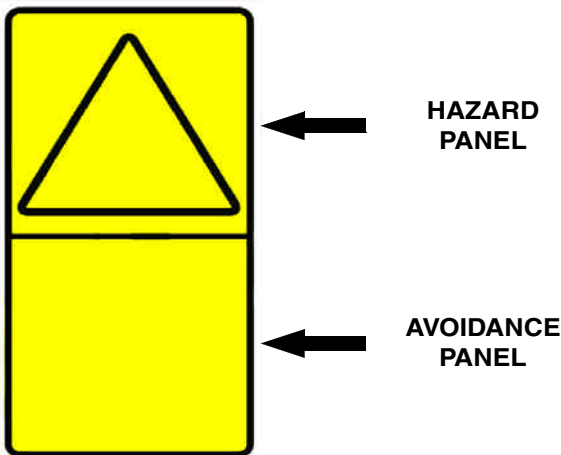

*Horizontal Configuration*

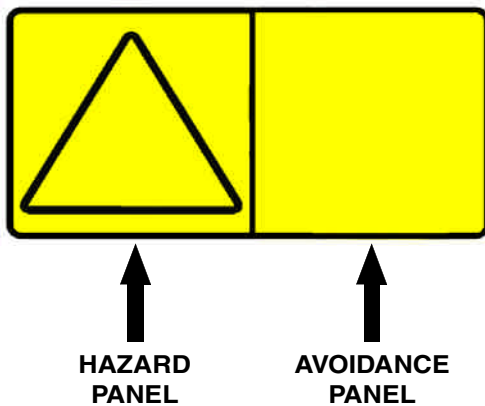

The format consists of the hazard panel(s) and the avoidance panel(s):

Hazard panels depict a potential hazard enclosed in a safety alert triangle.

Avoidance panels depict actions required to avoid the hazards.

A safety sign may contain more than one hazard panel and more than one avoidance panel.

**NOTE:** See the numbered MACHINE SIGNS (DECALS) on Page 19 and MACHINE SIGNS (DECALS) (CONT'D) on Page 20 for the machine location of each correspondingly numbered pictorial only decal.

#### 1. General Hazard Warning (7168038)

This safety sign is located in the operator cab in the lower right hand corner.



#### AVOID INJURY OR DEATH

Never use the loader without instructions. Read Operation & Maintenance Manual and Handbook.

Never modify equipment or use attachments not approved by Bobcat Company.

On slopes, keep heavy end of loader uphill.

Do not travel or turn with lift arms up. Load, unload and turn on flat level ground. Do not exceed Rated Operating Capacity (see sign on loader).

W-2837-0310



**MACHINE SIGNS (DECALS) (CONT'D)**

**Pictorial Only Safety Signs (Cont'd)**

**2. High Range Speeds (7184346)**

This safety sign is located in the operator cab on loaders equipped with a seat belt with three-point restraint.



**HITTING OBSTRUCTIONS AT HIGH RANGE SPEEDS  
CAN CAUSE SERIOUS INJURY OR DEATH**  
Fasten shoulder belt for additional restraint when  
operating at high range speeds.

W-2754-0908

**3. SJC Left Hand Joystick (7168082)**

This safety sign is located in the operator cab on the left  
armrest.

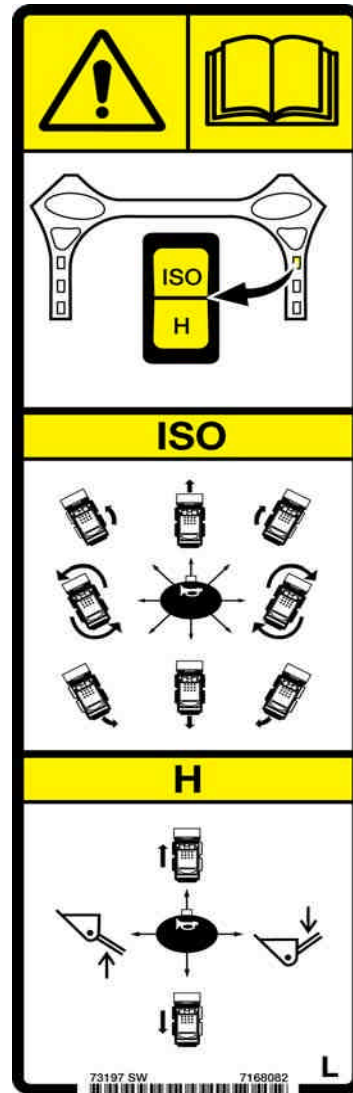

**ACCIDENTAL LOADER MOVEMENT CAN CAUSE  
SERIOUS INJURY OR DEATH**  
Read and understand the Operation & Maintenance  
Manual for more information.

- Drive, lift arm and tilt functions operate on different joysticks in each control mode.
- Know and understand the selected control mode before operating.

W-2788-0309



**MACHINE SIGNS (DECALS) (CONT'D)**

**Pictorial Only Safety Signs (Cont'd)**

**4. SJC Control Pattern Switch (7177707)**

This safety sign is located in the operator cab around the SJC control pattern switch on the right panel.

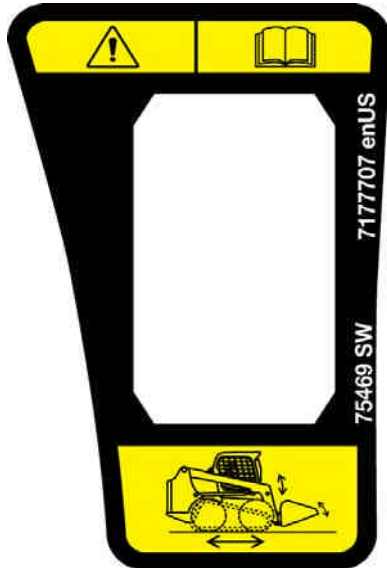

**ACCIDENTAL LOADER MOVEMENT CAN CAUSE  
SERIOUS INJURY OR DEATH**

Read and understand the Operation & Maintenance Manual for more information.

- Drive, lift arm and tilt functions operate on different joysticks in each control mode.
- Know and understand the selected control mode before operating.

W-2788-0309

**5. To Leave the Loader (7168143)**

This safety sign is located in the operator cab in the lower right hand corner.

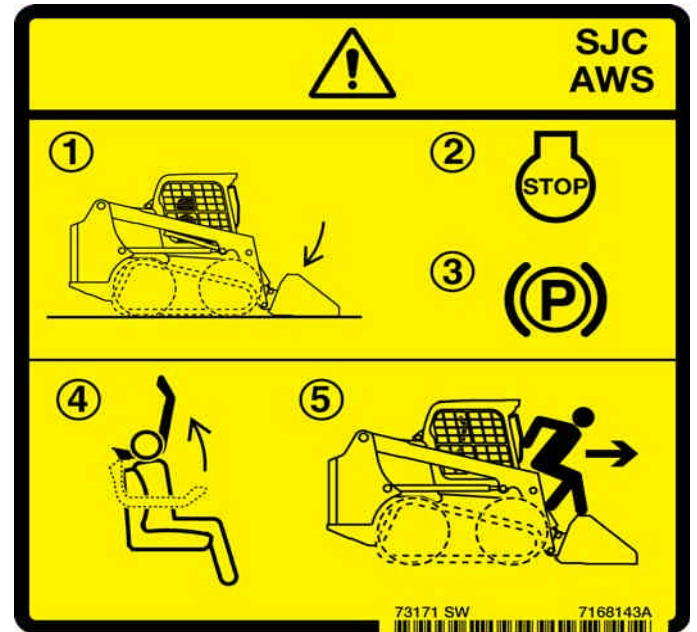

**AVOID INJURY OR DEATH**

**TO LEAVE THE LOADER:**

1. Lower the lift arms and put attachment flat on the ground.
2. Stop the engine.
3. Engage the brake.
4. Raise seat bar.
5. Exit the loader.

W-2839-0310

**MACHINE SIGNS (DECALS) (CONT'D)**

**Pictorial Only Safety Signs (Cont'd)**

**6. Back-Up Alarm (7180087)**

This safety sign is located in the operator cab on the lower left side.



**AVOID INJURY OR DEATH**

- Always keep bystanders away from the work area and travel path.
- The operator must always look in the direction of travel.
- The back-up alarm must sound when operating the machine in the reverse direction.

W-2783-0409

**7. Tipping, Rollover or Loss of Visibility (7168037)**

This safety sign is located on the back side of the lift arms facing the operator.



**TIPPING, ROLLOVER OR LOSS OF VISIBILITY CAN  
CAUSE SERIOUS INJURY OR DEATH**  
Carry load low.

W-2836-0310

MACHINE SIGNS (DECALS) (CONT'D)

Pictorial Only Safety Signs (Cont'd)

8. Frame Raising (7168034)

This safety sign is located on the front of the loader.



**AVOID DEATH**

Attachment can be forced against the ground and cause front frame to raise.

Never go under or reach under lift arms or lift cylinder without an approved lift arm support device installed.

D-1021-0310

9. Falling Hazard (7168040)

This safety sign is located on the front of the loader.



**AVOID INJURY OR DEATH**

- Never carry riders.
- Never use loader as a man lift or work platform.

W-2835-0310

**MACHINE SIGNS (DECALS) (CONT'D)**

**Pictorial Only Safety Signs (Cont'd)**

**10. Lift Arm Crushing (7168033)**

This safety sign is located on the front of the loader.



**AVOID DEATH**

Keep out of this area when lift arms are raised unless supported by an approved lift arm support device.

Moving lift arm control or failure of a part can cause lift arms to drop.

D-1020-0310

**11. Flying Debris or Objects (7168039)**

This safety sign is located on compact track loader undercarriages near the grease cylinder tensioning fittings.

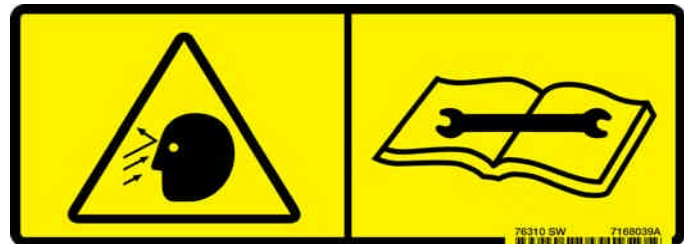

**HIGH PRESSURE GREASE CAN  
CAUSE SERIOUS INJURY**

- Do not loosen grease fitting.
- Do not loosen bleed fitting more than 1 - 1/2 turns.

W-2781-0109

MACHINE SIGNS (DECALS) (CONT'D)

Pictorial Only Safety Signs (Cont'd)

12. Single-Point Lift (7142142)

This safety sign is located on the side arm of the single-point lift.



13. Four-Point Lift (7168020)

This safety sign is located on the front of the loader.



FAILURE OF THE LIFT ASSEMBLY CAN CAUSE  
SERIOUS INJURY OR DEATH

BEFORE LIFTING LOADER:

1. Check the hardware and fasteners of the Single Point Lift and Operator Cab (ROPS) for proper torque.
  2. Inspect Single Point Lift for damage or cracked welds. Repair or replace components as necessary.
- No riders on loader during lifting. Keep 5 m (15 ft) away while lifting.
  - See Operation & Maintenance Manual for more information.

W-2841-0910



FAILURE OF THE LIFT ASSEMBLY CAN CAUSE  
SERIOUS INJURY OR DEATH

BEFORE LIFTING LOADER:

1. Check the hardware and fasteners at all lift points for proper torque.
  2. Inspect lift points for damage or cracked welds. Repair or replace components as necessary.
- No riders on loader and keep 5 m (15 ft) away while lifting.
  - See Operation & Maintenance Manual for more information.

W-2840-0910

MACHINE SIGNS (DECALS) (CONT'D)

Pictorial Only Safety Signs (Cont'd)

14. Hot Pressurised Fluid (7169699)

This safety sign is located on the engine coolant tank cap.



**HOT PRESSURISED FLUID CAN CAUSE  
SERIOUS BURNS**

- Never open hot.
- OPEN SLOWLY.

W-2755-EN-0909

15. High Pressure Gas (7169291)

This safety sign is located on the gas spring component(s) supporting the cab and also on the front door option.



**HIGH PRESSURE GAS CAN RELEASE ROD AND  
CAUSE SERIOUS INJURY OR DEATH**

- Do not open cylinder.
- See Service Manual for more information.

W-2756-0908

**MACHINE SIGNS (DECALS) (CONT'D)**

**Pictorial Only Safety Signs (Cont'd)**

**16. Crush Hazard (6713507)**

This safety sign is located on the side of each lift arm.



Keep away from the operating machine to avoid serious injury or death.

W-2520-0106

**17. Lift Arm Crushing (7170355)**

This safety sign is located on certain hoses or tubelines inside the loader frame underneath the operator cab.



**AVOID DEATH**

- Disconnecting hydraulic lines can cause the lift arms or attachment to drop.
- Always use an approved lift arm support when lift arms are in a raised position.

D-1008-0409

**MACHINE SIGNS (DECALS) (CONT'D)**

**Pictorial Only Safety Signs (Cont'd)**

**18. Service Checklist And Schedule (7205727)**

This safety sign is located inside the rear door (tailgate).

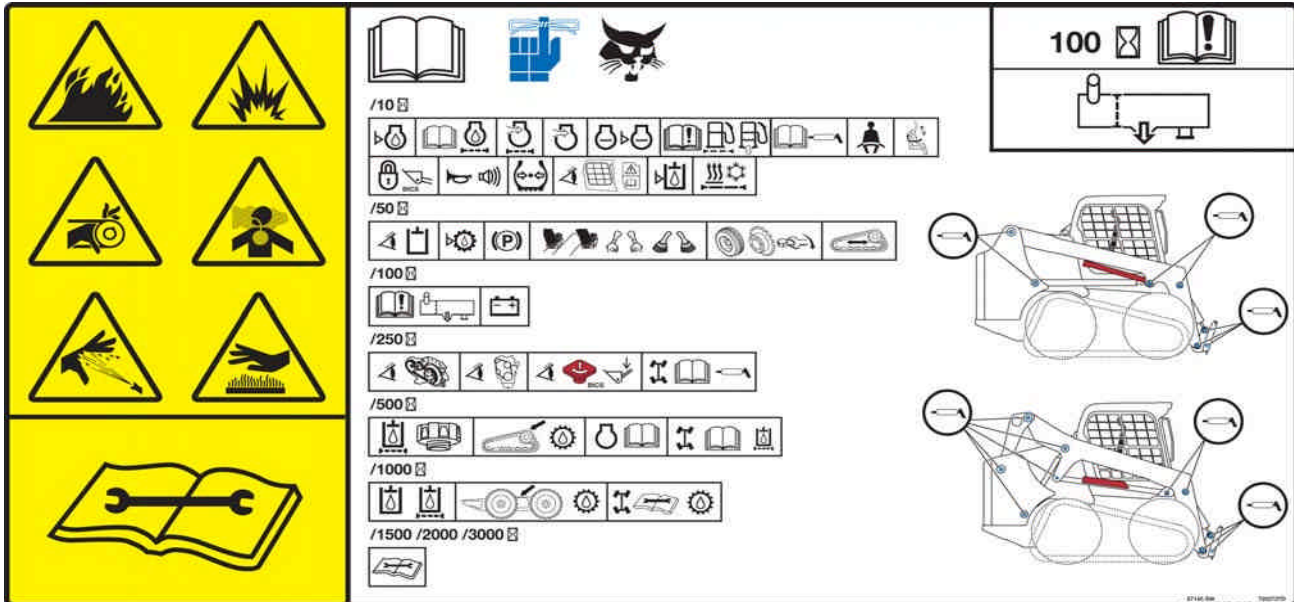

**! WARNING**

**AVOID INJURY OR DEATH**

- Keep door / cover closed except for service.
- Keep engine clean of flammable material.
- Keep body, loose objects and clothing away from electrical contacts, moving parts, hot parts and exhaust.
- Do not use the machine in space with explosive dusts or gases or with flammable material near exhaust.
- Never use ether or starting fluid on diesel engine with glow plugs or air intake heater. Use only starting aids as approved by engine manufacturer.
- Leaking fluids under pressure can enter skin and cause serious injury.
- Battery acid causes severe burns; wear goggles. If acid contacts eyes, skin, or clothing, flush with water. For contact with eyes, flush and get medical attention.
- Battery makes flammable and explosive gas. Keep arcs, sparks, flames and lighted tobacco away.
- For jump start, connect negative cable to the machine engine last (never at the battery). After jump start, remove negative connection at the engine first.
- Exhaust gases can kill. Always ventilate.

W-2782-0409

**IMPORTANT**

This machine is factory equipped with a spark arrester exhaust system that must be maintained for proper function.

- **WITH MUFFLER**  
The muffler chamber must be emptied every 100 hours of operation to keep it in working condition.
- **WITH SELECTIVE CATALYST REDUCTION (SCR) AND / OR DIESEL OXIDATION CATALYST (DOC)**  
Do not remove or modify the DOC or SCR.

The SCR must be maintained according to the instructions in the Operation & Maintenance Manual for proper function.

- **WITH DIESEL PARTICULATE FILTER (DPF)**  
The DPF must be maintained according to the instructions in the Operation & Maintenance Manual for proper function.

(If this machine is operated on flammable forest, brush or grass cover land, a spark arrester attached to the exhaust system may be required and must be maintained in working order. Refer to local laws and regulations for spark arrester requirements.)

I-2350-EN-1114



**MACHINE SIGNS (DECALS) (CONT'D)**

**Pictorial Only Safety Signs (Cont'd)**

**19. Lift Arm Support Device (7177072)**

This safety sign is located on the outside of the operator cab on the lower right side.

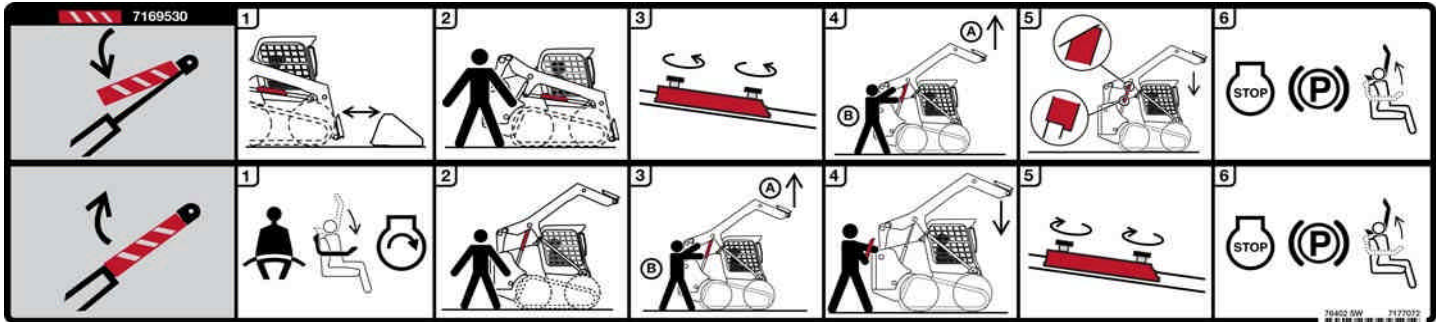

*To Install Approved Lift Arm Support:*

1. Remove attachment from loader.
2. Stay in seat while second person removes lift arm support from storage position.
3. Remove clamping knobs and lift arm support.
4. Raise lift arms while second person positions lift arm support against cylinder rod.
5. Lower lift arms slowly until lift arm support is held securely between lift arm and cylinder.
6. Stop the engine, engage the parking brake and raise the seat bar.

*To Remove Lift Arm Support:*

1. Fasten seat belt and lower seat bar before starting the engine.
2. Stay in seat while second person removes lift arm support from cylinder rod.
3. Raise lift arms while second person removes lift arm support from cylinder rod.
4. Stay in seat until the lift arms are lowered all the way.
5. Return lift arm support to storage position and secure with clamping knobs.
6. Stop the engine, engage the parking brake and raise the seat bar.

**NOTE: More illustrated and detailed information regarding Installing and Removing the lift arm support device is located in this manual. (See LIFT ARM SUPPORT DEVICE on Page 129.)**



## OPERATING INSTRUCTIONS

INTENDED USE .....	36
INSTRUMENT PANEL IDENTIFICATION .....	37
Overview .....	37
Left Panel .....	38
Display Screen .....	40
Right Panel (Standard Key Panel) .....	41
Right Panel (Keyless Start Panel) .....	41
Right Panel (Deluxe Instrumentation Panel) .....	42
Left Switch Panel .....	44
Right Switch Panel .....	44
Left Side Lower Panel .....	45
Right Side Lower Panel .....	45
Radio .....	46
CONTROL IDENTIFICATION .....	48
Selectable Joystick Controls (SJC) .....	48
OPERATOR CAB .....	49
Description .....	49
Side Windows .....	49
Door Operation .....	49
Front Wiper .....	50
Cab Light .....	50
BOBCAT INTERLOCK CONTROL SYSTEM (BICS™) .....	51
Description .....	51
Operation .....	51
SEAT BAR RESTRAINT SYSTEM .....	52
Description .....	52
Operation .....	52
SELECTIVE CATALYTIC REDUCTION (SCR) SYSTEM .....	53
Description .....	53
Diesel Exhaust Fluid (DEF) / AdBlue® Level .....	53
DeSOX Process .....	54
SCR System Codes .....	56
Diesel Exhaust Fluid (DEF) / AdBlue® Unsatisfactory Quality .....	57
SCR System Component Tampering .....	57
EGR Impeded .....	58
Diesel Exhaust Fluid (DEF) / AdBlue® Dosing Interruption .....	58
PARKING BRAKE .....	59
Operation .....	59
TRACTION LOCK OVERRIDE .....	59
Description .....	59
Operation .....	59



ENGINE SPEED CONTROL .....	60
Operation .....	60
AUTO IDLE .....	60
Description .....	60
Operation .....	60
LIFT ARM BYPASS CONTROL .....	61
Description .....	61
Operation .....	61
EMERGENCY EXIT .....	62
Rear Window Identification .....	62
Rear Window Removal (Latches) .....	62
Rear Window Removal (Rubber Cord) .....	62
External Access (Rear Window With Latches) .....	63
External Access (Rear Window With Rubber Cord) .....	63
Front Door .....	63
BACK-UP ALARM SYSTEM .....	65
Description .....	65
Operation .....	65
DRIVING AND STEERING THE LOADER .....	66
Operation (SJC) In 'ISO' Control Pattern .....	66
Operation (SJC) In 'H' Control Pattern .....	67
STOPPING THE LOADER .....	68
Using The Joysticks .....	68
TWO-SPEED CONTROL .....	69
Description .....	69
Operation .....	69
SPEED MANAGEMENT .....	70
Description .....	70
Operation .....	70
Changing The Factory Default Setting .....	71
DRIVE RESPONSE .....	72
Description .....	72
Operation .....	72
STEERING DRIFT COMPENSATION .....	74
Description .....	74
Operation .....	74
LIFT AND TILT COMPENSATION .....	76
Description .....	76
Operation .....	76



HYDRAULIC CONTROLS .....	78
Selectable Joystick Controls (SJC) In 'ISO' Control Pattern .....	78
Selectable Joystick Controls (SJC) In 'H' Control Pattern .....	78
Hydraulic Bucket Positioning .....	79
Automatic Ride Control .....	80
Reversing Fan .....	81
FRONT Auxiliary Hydraulics Operation .....	82
FRONT Auxiliary Hydraulics Operation (CONTINUOUS FLOW) .....	83
FRONT Auxiliary Hydraulics Operation (REVERSE CONTINUOUS FLOW) .....	83
REAR Auxiliary Hydraulics Operation .....	84
High-Flow Auxiliary Hydraulics Operation .....	85
Quick Couplers .....	86
Relieve Auxiliary Hydraulic Pressure (Loader And Attachment) .....	87
 ATTACHMENT CONTROL DEVICE (ACD) .....	 88
Description .....	88
 DAILY INSPECTION .....	 89
Daily Inspection And Maintenance .....	89
 PRE-STARTING PROCEDURE .....	 91
Entering The Loader .....	91
Operation & Maintenance Manual And Operator's Handbook Locations .....	91
Seat Adjustment .....	92
Seat Belt Adjustment .....	93
Seat Bar .....	93
Joystick Position Adjustment .....	94
 STARTING THE ENGINE .....	 95
Standard Key Panel .....	95
Keyless Start Panel .....	97
Deluxe Instrumentation Panel .....	99
Warming The Hydraulic / Hydrostatic System .....	101
Cold Temperature Starting .....	101
Cold Temperature Engine Speed Control .....	101
 MONITORING THE DISPLAY PANELS .....	 102
Left Panel .....	102
Warning And Shutdown .....	102
 STOPPING THE ENGINE AND LEAVING THE LOADER .....	 103
Procedure .....	103
 COUNTERWEIGHTS .....	 104
Description .....	104
Effect On The Loader And Loader Operation .....	104
When To Consider Using Counterweights .....	104
When To Consider Removing Counterweights .....	104
Accessories That Affect Machine Weight .....	104



ATTACHMENTS .....	105
Choosing The Correct Bucket .....	105
Pallet Fork .....	105
Installing And Removing The Attachment (Hand Lever Bob-Tach) .....	106
Installing And Removing The Attachment (Power Bob-Tach) .....	109
 TRACK UNDERCARRIAGE SYSTEM .....	 112
Introduction .....	112
Compact Track Loader Operating And Maintenance Tips .....	112
 OPERATING PROCEDURE .....	 114
Inspect The Work Area .....	114
Basic Operating Instructions .....	114
Driving On Public Roads .....	114
Operating With A Full Bucket .....	115
Operating With An Empty Bucket .....	115
 TOWING THE LOADER .....	 116
Procedure .....	116
 LIFTING THE LOADER .....	 116
Single-Point Lift .....	116
Four-Point Lift .....	117
 TRANSPORTING THE LOADER ON A TRAILER .....	 118
Loading And Unloading .....	118
Fastening .....	118

**INTENDED USE**

This machine is classified as a Skid-Steer Loader as defined in ISO 6165. This machine has tracks and commonly a front mounted bucket for the principle intended functions of digging, moving, levelling, lifting, carrying, and loading loose materials such as earth, gravel, or crushed rock.

Additional Bobcat approved attachments allow this machine to perform other tasks described in the attachment Operation & Maintenance Manuals.

Examples of intended use include:

*Digging*

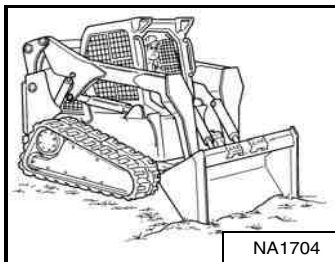

NA1704

*Backfilling*

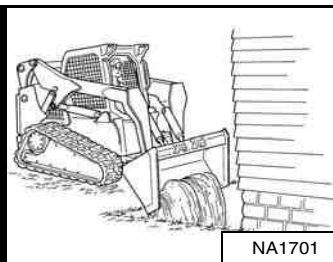

NA1701

*Leveling*

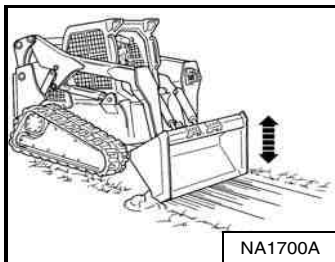

NA1700A

*Piling Material*

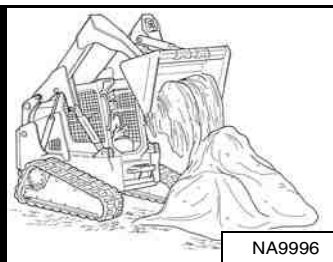

NA9996

*Loading Material*

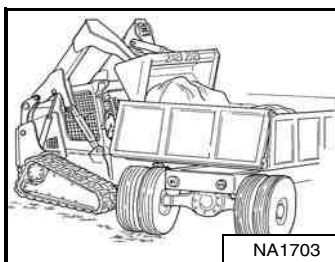

NA1703

*Moving Palletized Loads*

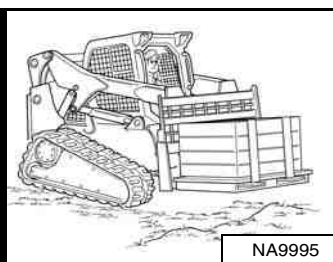

NA9995

**! WARNING**

Load, unload and turn on flat level ground. Do not exceed Rated Operating Capacity (ROC) shown on sign (decal) in cab. Failure to obey warnings can cause the machine to tip or rollover and cause injury or death.

W-2056-1112

**! WARNING**

Never dump over an obstruction, such as a post, that can enter the operator cab. The machine could tip forward and cause injury or death.

W-2057-0694

**IMPORTANT**

Never drive forward when the hydraulic control for lift arms is in float position.

I-2005-1285

## INSTRUMENT PANEL IDENTIFICATION

### Overview

Figure 7



The left panel [Figure 7] is described in more detail. (See Left Panel on Page 38.)

Figure 8

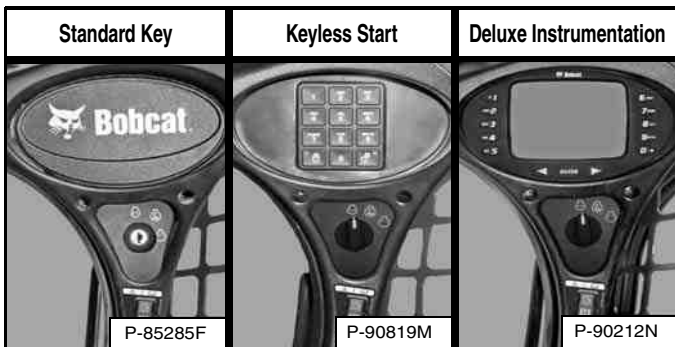

The right panel [Figure 8] is described in more detail. (See Right Panel (Standard Key Panel) on Page 41.), (See Right Panel (Keyless Start Panel) on Page 41.), or (See Right Panel (Deluxe Instrumentation Panel) on Page 42.)

Figure 9

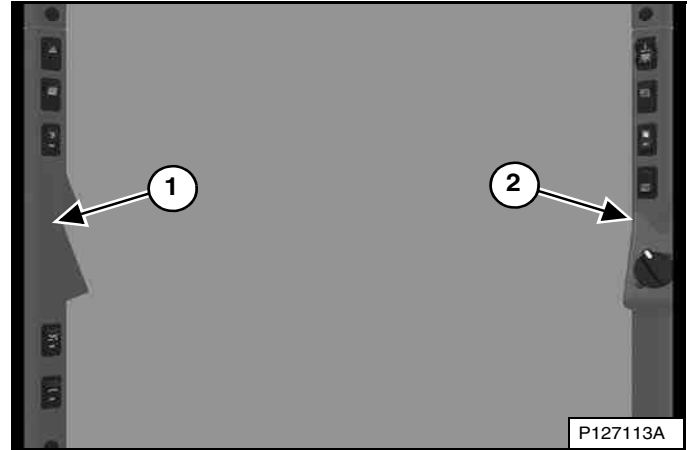

The left (Item 1) and right (Item 2) [Figure 9] switch panels are described in more detail. (See Left Switch Panel on Page 44.) and (See Right Switch Panel on Page 44.)

Figure 10

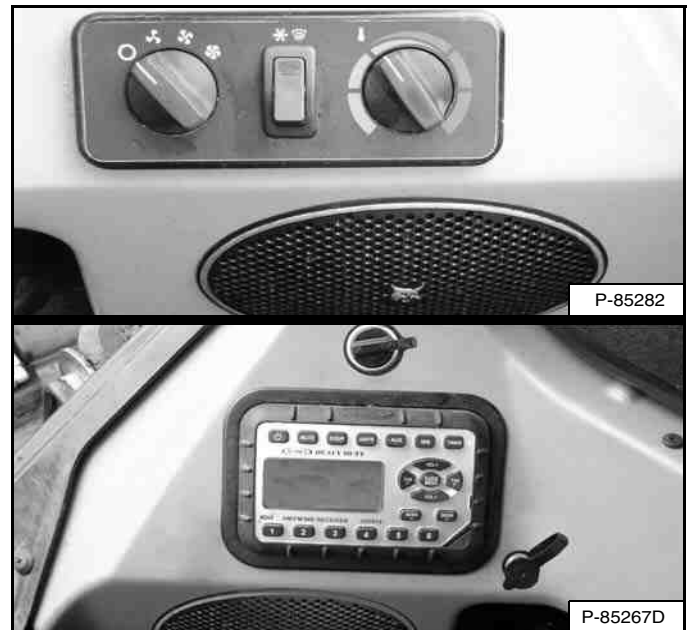

The left and right side lower panels [Figure 10] are described in more detail. (See Left Side Lower Panel on Page 45.) and (See Right Side Lower Panel on Page 45.)

**INSTRUMENT PANEL IDENTIFICATION (CONT'D)**

**Left Panel**

**Figure 11**

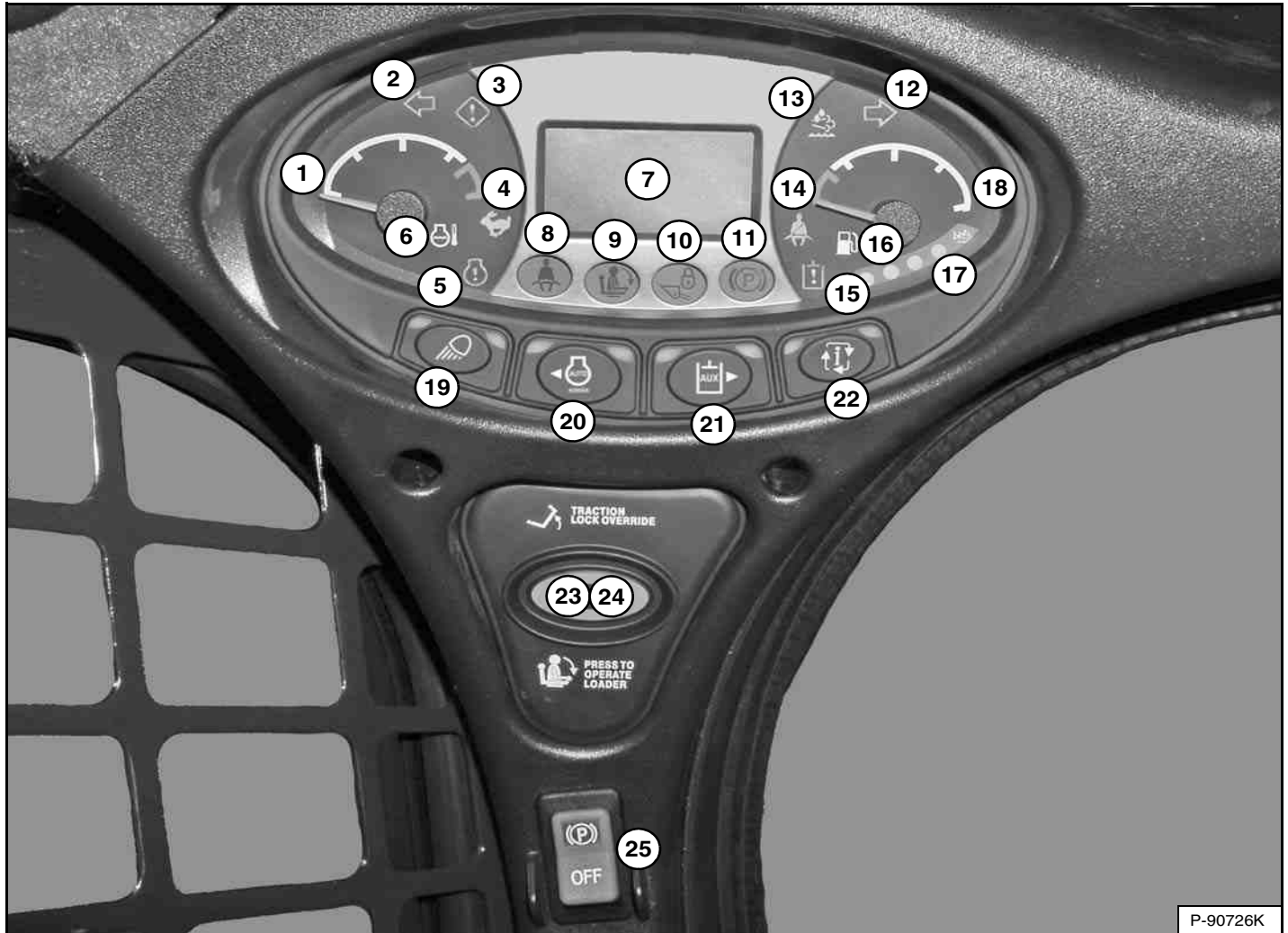

P-90726K

The left panel [Figure 11] is the same for all machines regardless of options and accessories.

ITEM	DESCRIPTION	FUNCTION / OPERATION
1	ENGINE TEMPERATURE GAUGE	Shows the engine coolant temperature.
2	LEFT TURN SIGNAL (Option)	Indicates left turn signals are ON.
3	GENERAL WARNING	Malfunction with one or more machine functions. (See Service Codes*)
4	TWO-SPEED	High range selected.
5	ENGINE MALFUNCTION	Engine malfunction or failure. (See Service Codes*)
6	ENGINE COOLANT TEMPERATURE	Engine coolant temperature high or sensor error.
7	DISPLAY SCREEN	Displays information. (See Display Screen in this manual.)
8	SEAT BELT	Instructs operator to fasten seat belt. Remains lit for 45 seconds.
9	SEAT BAR	The light is on when the seat bar is UP.
10	LIFT AND TILT VALVE	The light is on when the lift and tilt functions cannot be operated.
11	PARKING BRAKE	The light is on when the loader cannot be driven.





**INSTRUMENT PANEL IDENTIFICATION (CONT'D)**

**Left Panel (Cont'd)**

ITEM	DESCRIPTION	FUNCTION / OPERATION
12	RIGHT TURN SIGNAL (Option)	Indicates right turn signals are ON.
13	DIESEL EXHAUST FLUID (DEF) / AdBlue® MALFUNCTION	Diesel exhaust fluid (DEF) / AdBlue® level low. (See DIESEL EXHAUST FLUID (DEF) / ADBLUE® SYSTEM in this manual.)
14	SHOULDER BELT	Instructs operator to fasten shoulder belt when operating in high range. Remains lit while in high range.
15	HYDRAULIC SYSTEM MALFUNCTION	Hydraulic system malfunction or failure. (See Service Codes*)
16	FUEL	Fuel level low or sensor error.
17	DIESEL EXHAUST FLUID (DEF) / AdBlue® LEVEL	Shows the amount of diesel exhaust fluid (DEF) / AdBlue® in the tank. (See SELECTIVE CATALYTIC REDUCTION (SCR) SYSTEM in this manual.)
18	FUEL GAUGE	Shows the amount of fuel in the tank.
19	LIGHTS without road option	Press once for REAR taillights. (Right green LED will light.) Press a second time to turn FRONT and REAR work lights ON. REAR taillights will turn OFF. (Left green LED will light.) Press a third time to turn all lights off. (Left and right green LEDs will be off.)
	LIGHTS with road option	Press once for FRONT boom light, license plate light and REAR taillights. (Right green LED will light.) Press a second time to turn FRONT and REAR work lights ON. FRONT boom light, license plate light and REAR taillights will turn OFF. (Left green LED will light.) Press a third time to turn all lights off. (Left and right green LEDs will be off.)
		Press and hold 5 seconds to show software version in display screen.
20	AUTO IDLE	Press once to engage auto idle. (Left green LED lights.) Press a second time to disengage. (See AUTO IDLE in this manual.)
		Move cursor to the left inside the DISPLAY SCREEN when using certain INFORMATION button menus.
21	AUXILIARY HYDRAULICS without high-flow option	Press once to activate the auxiliary hydraulic system. (Left green LED lights.) Press a second time to deactivate the system.
	AUXILIARY HYDRAULICS with high-flow option	Press once to activate the auxiliary hydraulic system. (Left green LED lights.) Press a second time to engage the HIGH-FLOW auxiliary hydraulics. (Left and right green LEDs light.) Press a third time to deactivate auxiliary hydraulics. (Left and right green LEDs off.)
		Move cursor to the right inside the DISPLAY SCREEN when using certain INFORMATION button menus.
22	INFORMATION	Cycles through (after each button press): <ul style="list-style-type: none"> <li>• Hourmeter (On startup)</li> <li>• Engine rpm</li> <li>• Battery voltage</li> <li>• Drive response menu</li> <li>• Steering drift compensation menu</li> <li>• Maintenance clock</li> <li>• Service codes*</li> </ul>
23	TRACTION LOCK OVERRIDE	Functions only when the seat bar is raised and the engine is running. Press once to unlock the brakes. Allows you to use the steering levers or joystick(s) to move the loader forward or backward when using the backhoe attachment. (See TRACTION LOCK OVERRIDE in this manual.) Press a second time to lock the brakes.
24	PRESS TO OPERATE LOADER	Press to activate the BICS™ when the seat bar is down and operator is seated in operating position. Button will light.
25	PARKING BRAKE (Standard on all loaders)	Press the top to engage the Parking Brake. Press the bottom to disengage. (See PARKING BRAKE in this manual.)

\* This manual contains a table with Service Code descriptions. (See DIAGNOSTIC SERVICE CODES on Page 190.)



## INSTRUMENT PANEL IDENTIFICATION (CONT'D)

### Display Screen

The display screen can display the following information:

- Operating hours
- Engine rpm
- Battery voltage
- Drive response setting
- Steering drift compensation setting
- Maintenance clock countdown
- Service codes
- Engine preheat countdown
- Speed management setting
- Lift and tilt compensation setting

**Figure 12**

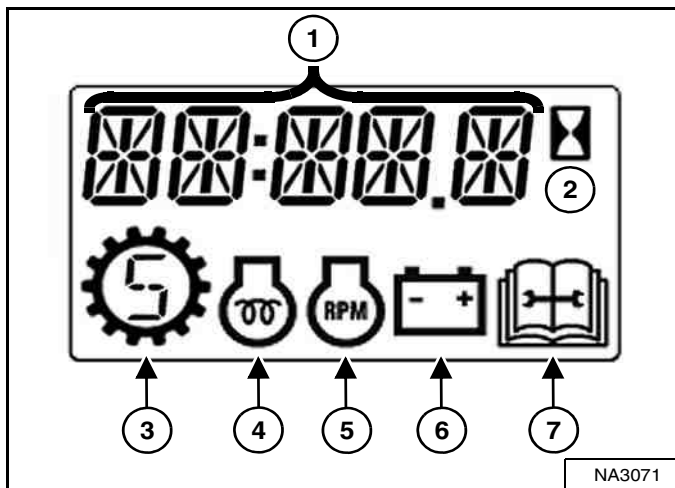

The display screen is shown in **[Figure 12]**. The data display will show operating hours upon start up.

1. **Data Display**
2. **Hourmeter**
3. **Speed Management**
4. **Engine Preheat**
5. **Engine RPM**
6. **Battery / Charging Voltage**
7. **Service**

INSTRUMENT PANEL IDENTIFICATION (CONT'D)

Right Panel (Standard Key Panel)

Figure 13



This machine may be equipped with a Standard Key Panel [Figure 13].

1. **Key Switch:** Used to turn the loaders electrical system on and off, and to start and stop the engine.
2. **Selectable Joystick Controls (SJC) Control Pattern Switch:** Press the top to select 'ISO' Control Pattern; bottom to select 'H' Control Pattern.

Right Panel (Keyless Start Panel)

Figure 14

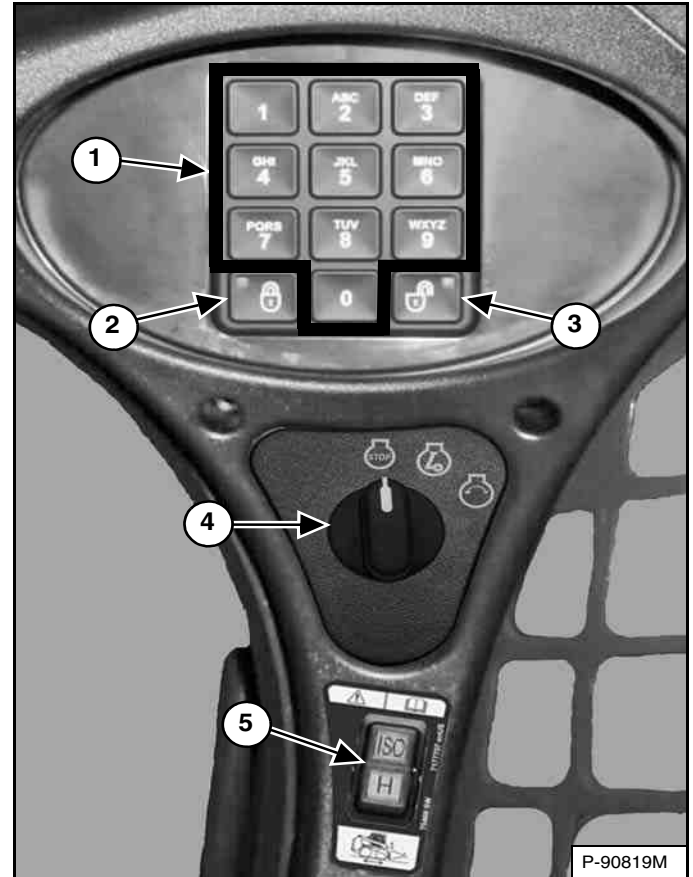

This machine may be equipped with a Keyless Start Panel [Figure 14].

1. **Keypad (keys 1 through 0):** Used to enter a number code (password) to allow starting the engine. An asterisk will show in the left panel display screen for each key press.
2. **LOCK Key:** Used to lock keypad. The lock key will display a red light to indicate a password is required to start the loader. (See Password Lockout Feature on Page 208.)
3. **UNLOCK Key:** Used to unlock keypad. The unlock key will display a green light to indicate the loader can be started without a password. (See Password Lockout Feature on Page 208.)
4. **Key Switch:** Used to turn the loaders electrical system on and off, and to start and stop the engine.
5. **Selectable Joystick Controls (SJC) Control Pattern Switch:** Press the top to select 'ISO' Control Pattern; bottom to select 'H' Control Pattern.

## INSTRUMENT PANEL IDENTIFICATION (CONT'D)

### Right Panel (Deluxe Instrumentation Panel)

Figure 15

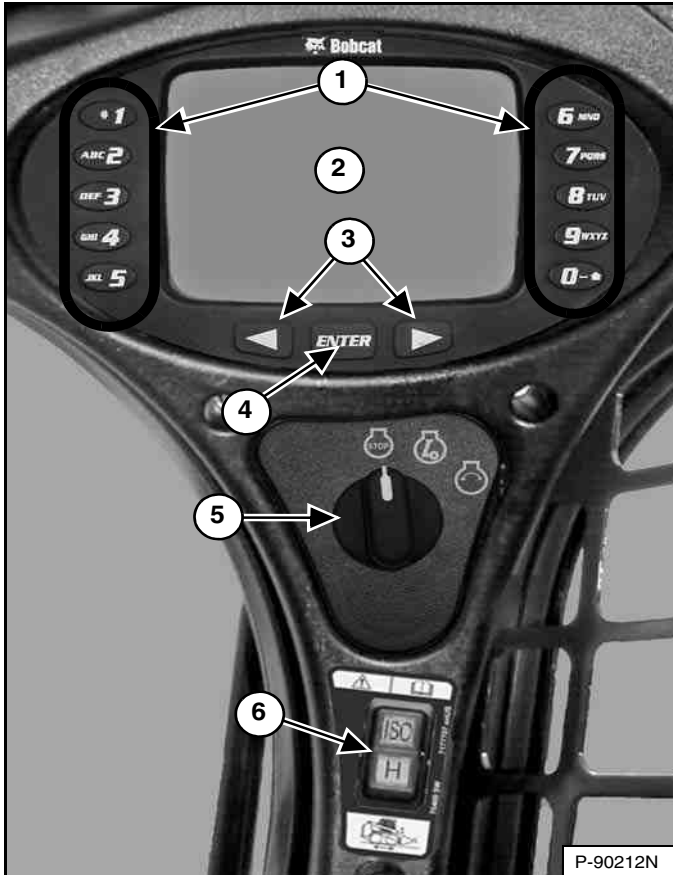

This machine may be equipped with a Deluxe Instrumentation Panel [Figure 15].

1. **Keypad (keys 1 through 0):** The keypad has two functions:
  - To enter a number code (password) to allow starting the engine.
  - To enter a number as directed for further use of the display screen.
2. **Display Screen:** The display screen is where all system setup, monitoring, and error conditions are displayed.
3. **Scroll Buttons:** Used to scroll through display screen choices.
4. **ENTER Button:** Used to make selections on the display screen.
5. **Key Switch:** Used to turn the loaders electrical system on and off, and to start and stop the engine.

6. **Selectable Joystick Controls (SJC) Control Pattern Switch:** Press the top to select 'ISO' Control Pattern; bottom to select 'H' Control Pattern.

## INSTRUMENT PANEL IDENTIFICATION (CONT'D)

### Right Panel (Deluxe Instrumentation Panel) (Cont'd)

Figure 16



The first screen you will see on your new loader is shown in [Figure 16].

When this screen is on the display you can enter the password and start the engine or change the default language.

**NOTE:** Your new loader (with Deluxe Instrumentation Panel) will have an Owner Password. Your dealer will provide you with this password. Change the password to one that you will easily remember to prevent unauthorised use of your loader. (See Changing The Owner Password on Page 209.) Keep your password in a safe location for future needs.

#### *Change Language:*

Press the left or right scroll button to cycle through the languages. The language that is stopped on becomes the default language used for the Deluxe Instrumentation Panel [Figure 16].

The language can be changed at any time. (See CONTROL PANEL SETUP on Page 205.)

#### *Enter The Password:*

Use the numbers on the keypad to enter the password, then press the [ENTER] button. A symbol will appear on the display screen for each number entered. The left scroll button can be used to backspace if an incorrect number is entered.

If the correct password is not entered, [INVALID PASSWORD TRY AGAIN] will appear on the display screen and the password will have to be re-entered.

See CONTROL PANEL SETUP for further description of screens to set up the system for your use. (See CONTROL PANEL SETUP on Page 205.)



INSTRUMENT PANEL IDENTIFICATION (CONT'D)

Left Switch Panel

Right Switch Panel

Figure 17

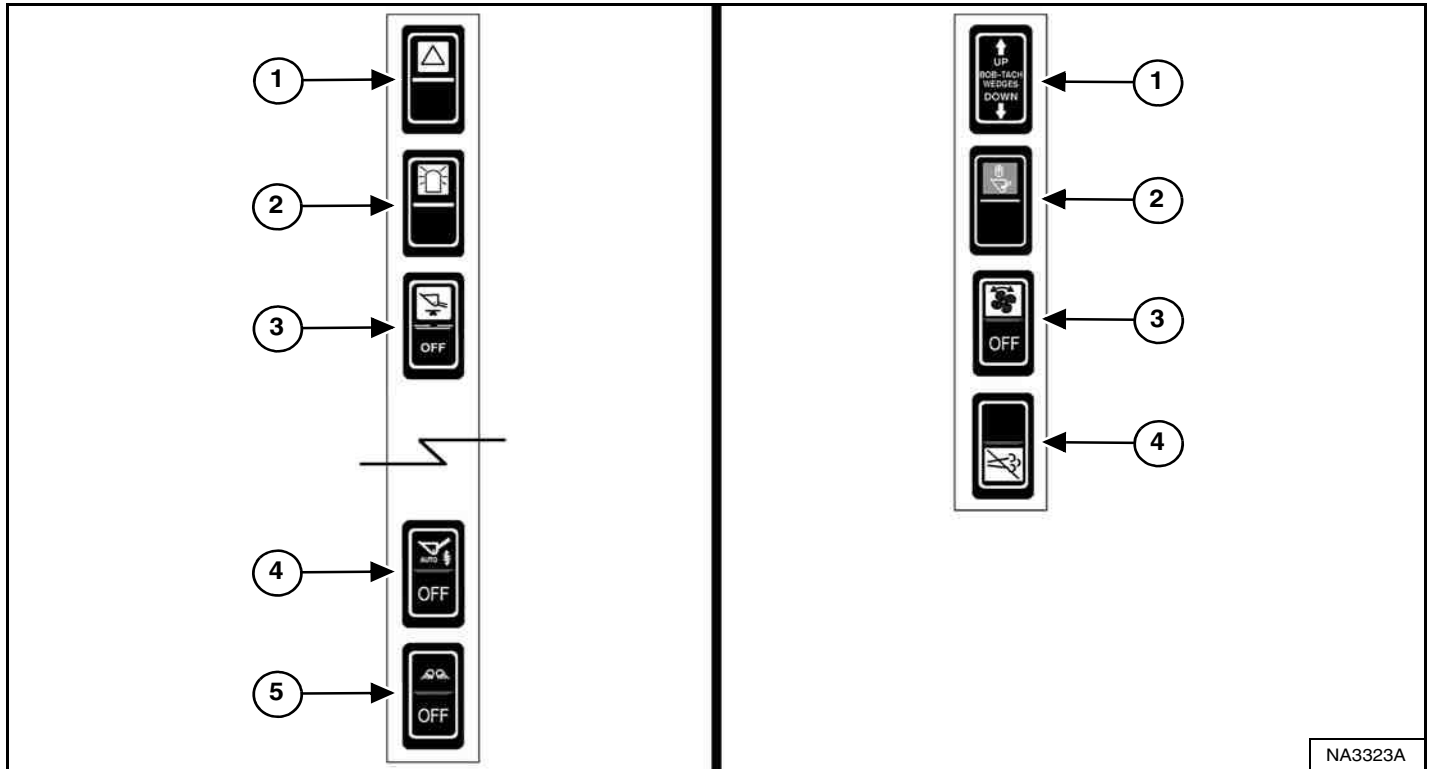

NA3323A

ITEM	DESCRIPTION	FUNCTION / OPERATION
1	FOUR-WAY FLASHER LIGHTS (Option)	Press the top to turn lights ON; bottom to turn OFF.
2	ROTATING BEACON (Option) <b>OR</b> STROBE LIGHT (Option)	Press the top to turn light ON; bottom to turn OFF.
3	HYDRAULIC BUCKET POSITIONING	Press the top to engage Hydraulic Bucket Positioning; bottom to disengage.
4	AUTOMATIC RIDE CONTROL (Option)	Press the top to engage Automatic Ride Control; bottom to disengage.
5	SIDE LIGHTING (Option)	Press the top to turn lights ON; bottom to turn OFF. <b>NOTE: Turn side lighting OFF when driving on public roads.</b>

**NOTE: Earlier models did not have switch locations four and five on the left switch panel.**

ITEM	DESCRIPTION	FUNCTION / OPERATION
1	POWER BOB-TACH (Option)	Press and hold the up arrow to disengage the Bob-Tach wedges. Press and hold the down arrow to engage the Bob-Tach wedges into the attachment mounting frame holes.
2	TRAVEL LOCK	Press the top of the switch to lock the lift and tilt hydraulic functions for travel. Press the bottom of the switch to turn travel lock OFF.
3	REVERSING FAN (Option)	Automatic Operation - middle position; Manual Operation - press top momentarily; press bottom to disengage.
4	DESOX INHIBIT (Option)	Press the bottom to inhibit DeSOX. See SELECTIVE CATALYTIC REDUCTION (SCR) SYSTEM in this manual.

**INSTRUMENT PANEL IDENTIFICATION (CONT'D)**

**Left Side Lower Panel**

**Figure 18**

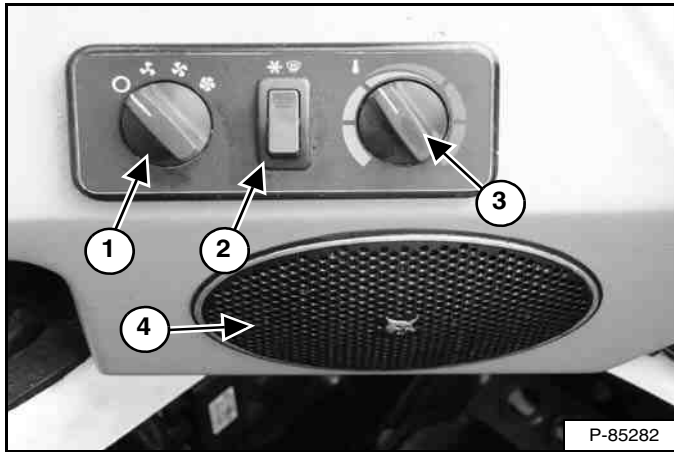

**Right Side Lower Panel**

**Figure 19**

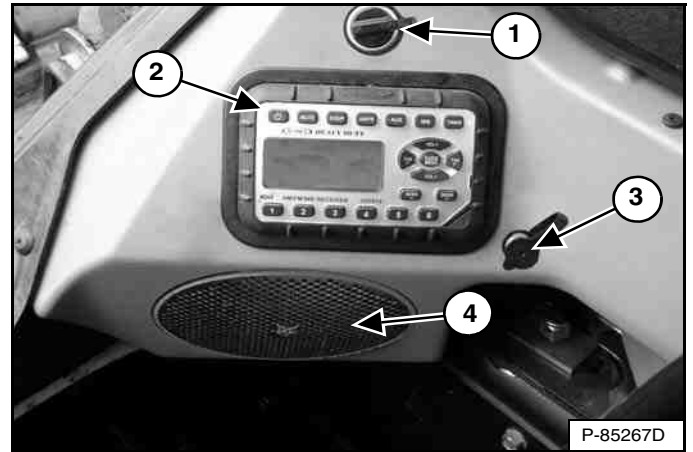

ITEM	DESCRIPTION	FUNCTION / OPERATION
1	FAN MOTOR (Option)	Turn clockwise to increase fan speed; anticlockwise to decrease. There are four positions; OFF-1-2-3.
2	AIR CONDITIONING / DEFROST SWITCH (Option)	Press top of switch to start; bottom to stop. Switch will light when started. Fan Motor (Item 1) must be ON for air conditioning to operate.
3	TEMPERATURE CONTROL (Option)	Turn clockwise to increase the temperature; anticlockwise to decrease.
4	SPEAKER (Option)	Left speaker used with optional radio.

ITEM	DESCRIPTION	FUNCTION / OPERATION
1	POWER PORT	Provides a 12 volt receptacle for accessories.
2	RADIO (Option)	See Radio in this manual.
3	HEADPHONE JACK (Option)	Used to connect headphones to the optional radio output. Automatically silences speakers when used.
4	SPEAKER (Option)	Right speaker used with optional radio.



INSTRUMENT PANEL IDENTIFICATION (CONT'D)

Radio

This machine may be equipped with a radio.

Figure 20

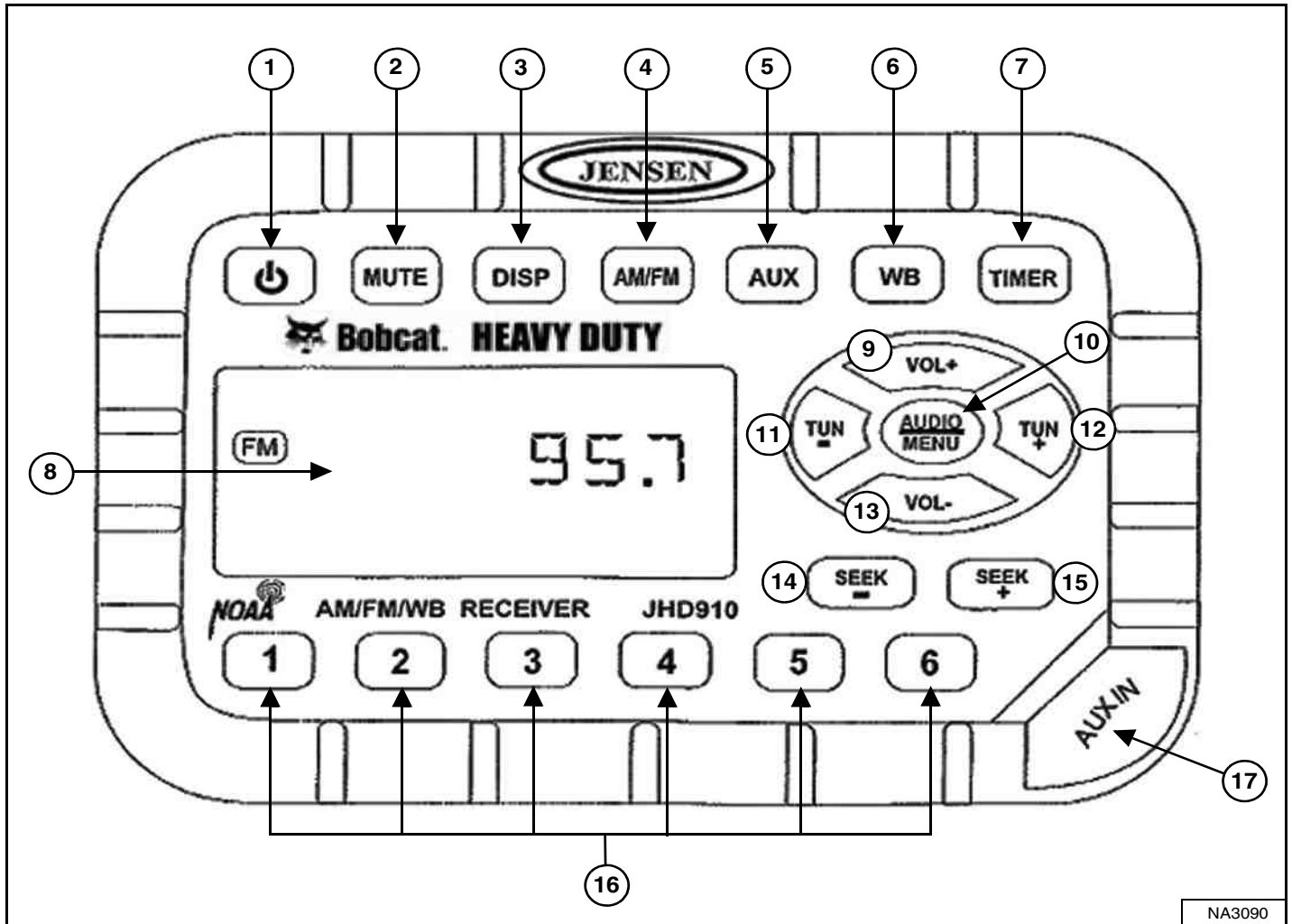

The table on the next page shows the DESCRIPTION and FUNCTION / OPERATION for each of the controls of the radio [Figure 20].

**NOTE:** See DISPLAY in the table for clock setting instructions.





**INSTRUMENT PANEL IDENTIFICATION (CONT'D)**

**Radio (Cont'd)**

ITEM	DESCRIPTION	FUNCTION / OPERATION
1	POWER	Press to turn ON; press again to turn OFF.
2	MUTE	Press to mute audio output; <b>[MUTE]</b> will appear in display screen; press again to turn OFF.
3	DISPLAY	Press to toggle between function mode (showing tuner frequency, auxiliary input, weather band information, or timer) and clock mode.
		Press and hold to enter clock setting mode; use FREQUENCY DOWN (TUN -) button to adjust hours and FREQUENCY UP (TUN +) button to adjust minutes; normal operation will resume automatically.
4	BAND	Press to select tuner mode. Press to cycle through 2 AM (MW) bands and 3 FM bands.
5	AUXILIARY	Press to select Auxiliary Input mode. Portable audio device (MP3 player) must be attached to auxiliary input jack.
6	WEATHER BAND	Press to select weather band; use FREQUENCY UP (TUN +) and FREQUENCY DOWN (TUN -) buttons to adjust to the clearest station.
		The weather alert feature, if activated, will automatically switch from the current function to the weather band if a weather warning is received. See AUDIO / MENU ADJUSTMENT in this table.
7	TIMER	Press to access timer mode. Press to start the timer function; press again to stop timer; press again to resume timer or press and hold to reset timer and exit from timer mode.
8	DISPLAY SCREEN	Displays the time, frequency, and activated functions.
9	VOLUME UP	Adjusts volume up; current volume (0 – 40) will appear briefly in display screen.
10	AUDIO / MENU ADJUSTMENT	AUDIO ADJUSTMENT: Press to cycle through bass, treble, and balance settings; use VOLUME UP (VOL +) and VOLUME DOWN (VOL -) buttons to adjust when desired option is displayed; normal operation will resume automatically.
		MENU ADJUSTMENT: Press and hold for 3 seconds to enter menu adjustment settings; press to cycle through the following settings; use VOLUME UP (VOL +) and VOLUME DOWN (VOL -) buttons to adjust when desired option is displayed; normal operation will resume automatically. <ul style="list-style-type: none"> <li>• Beep Confirm (On or Off) – Determines if beep will sound with each button press.</li> <li>• Operation Region (USA or Europe) – Selects the appropriate region.</li> <li>• Clock Display (12 or 24) – Selects a 12-hour or 24-hour clock display.</li> <li>• Display Brightness (Low, Medium, or High) – Determines brightness level of display screen.</li> <li>• Backlight Colour (Amber or Green) – Determines backlight colour of display screen.</li> <li>• Power On Volume (0 – 40) – Selects default volume setting when radio is turned on.</li> <li>• WB Alert (On or Off) – Determines if weather band alert feature is activated.</li> </ul>
11	FREQUENCY DOWN	Press to manually tune the radio frequency down.
12	FREQUENCY UP	Press to manually tune the radio frequency up.
13	VOLUME DOWN	Adjusts volume down; current volume (0 – 40) will appear briefly in display screen.
14	SEEK FREQUENCY DOWN	Press to automatically tune frequency down to next strong station.
15	SEEK FREQUENCY UP	Press to automatically tune frequency up to next strong station.
16	PRESET STATIONS	Used to store and recall stations for each AM and FM band. Press and hold to store current station; press button to recall station.
17	AUXILIARY INPUT JACK	Connect headphone or line output of portable audio device (MP3 player) to 3,5 mm (1/8 in) jack and press AUXILIARY button.



**CONTROL IDENTIFICATION**

**Selectable Joystick Controls (SJC)**

**Figure 21**

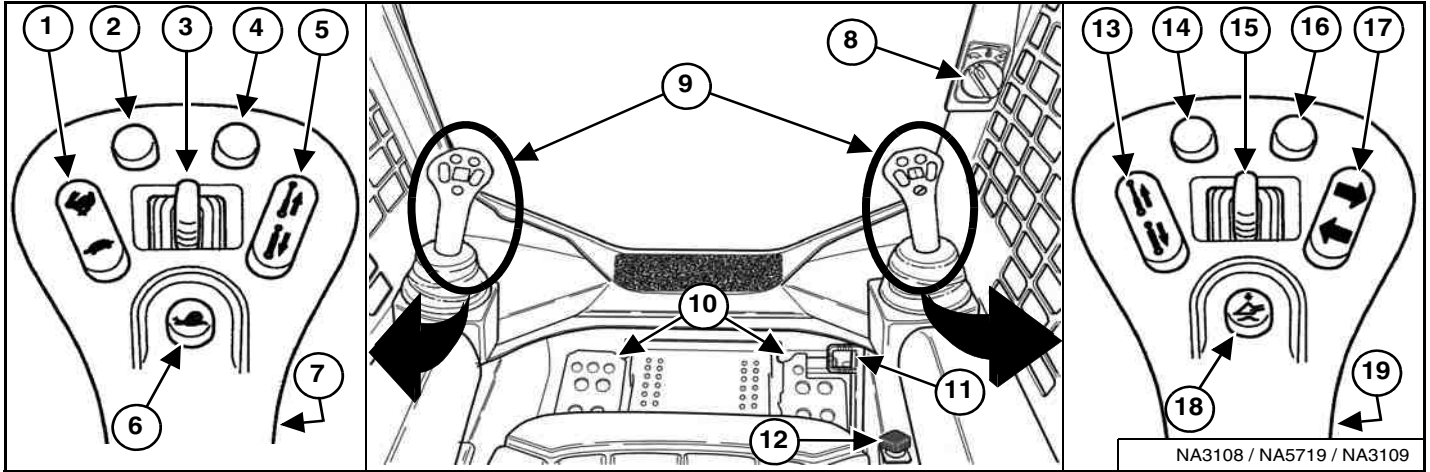

ITEM	DESCRIPTION	FUNCTION / OPERATION
1	TWO-SPEED CONTROL	See TWO-SPEED CONTROL in this manual.
	Also: SPEED MANAGEMENT	See SPEED MANAGEMENT in this manual.
2 *	STEERING DRIFT COMPENSATION	See STEERING DRIFT COMPENSATION in this manual.
	Also: DRIVE RESPONSE	See DRIVE RESPONSE in this manual.
3	REAR AUXILIARY HYDRAULICS (Option)	See REAR Auxiliary Hydraulics Operation in this manual.
	Also: ATTACHMENT FUNCTION CONTROL	See ATTACHMENT CONTROL DEVICE in this manual.
4 *	STEERING DRIFT COMPENSATION	See STEERING DRIFT COMPENSATION in this manual.
	Also: DRIVE RESPONSE	See DRIVE RESPONSE in this manual.
5	ATTACHMENT FUNCTION CONTROL	See ATTACHMENT CONTROL DEVICE in this manual.
6	SPEED MANAGEMENT	See SPEED MANAGEMENT in this manual.
7	FRONT HORN	Press the front switch to sound the front horn.
8	ENGINE SPEED CONTROL (HAND)	See ENGINE SPEED CONTROL in this manual.
9	JOYSTICKS	See DRIVING AND STEERING THE LOADER and HYDRAULIC CONTROLS in this manual.
10	FOOTRESTS	Keep your feet on the footrests at all times.
11	ENGINE SPEED CONTROL (FOOT)	See ENGINE SPEED CONTROL in this manual.
12	LIFT ARM BYPASS CONTROL	See LIFT ARM BYPASS CONTROL in this manual.
13	ATTACHMENT FUNCTION CONTROL	See ATTACHMENT CONTROL DEVICE in this manual.
14 *	NOT USED	---
15	FRONT AUXILIARY HYDRAULICS	See FRONT Auxiliary Hydraulics Operation in this manual.
16 *	NOT USED	---
17	TURN SIGNALS (Option)	Press the top to activate right signal; press again to turn off. Press the bottom to activate left signal; press again to turn off.
18	FLOAT CONTROL	See HYDRAULIC CONTROLS in this manual.
19	CONTINUOUS FLOW CONTROL FOR AUXILIARY HYDRAULICS	See FRONT Auxiliary Hydraulics Operation (CONTINUOUS FLOW) in this manual.

\* Also used as Attachment Function Control: See your attachment Operation & Maintenance Manual.

## OPERATOR CAB

### Description

The Bobcat loader has an operator cab (ROPS and FOPS) as standard equipment to protect the operator from rollover and falling objects. The seat belt must be worn for rollover protection.



Never modify operator cab by welding, grinding, drilling holes or adding attachments unless instructed to do so by Bobcat Company. Changes to the cab can cause loss of operator protection from rollover and falling objects, and result in injury or death.

W-2069-0200

### Side Windows

Figure 22

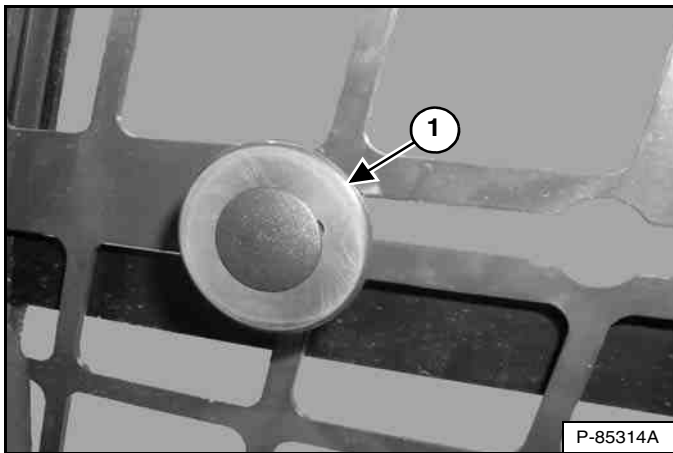

Pull the knob (Item 1) [Figure 22] and slide backward to open window. (Right side shown.) Release knob at cutout to lock in desired position. Pull the knob and slide forward to close window.

### Door Operation

This machine may be equipped with a front door.

Figure 23

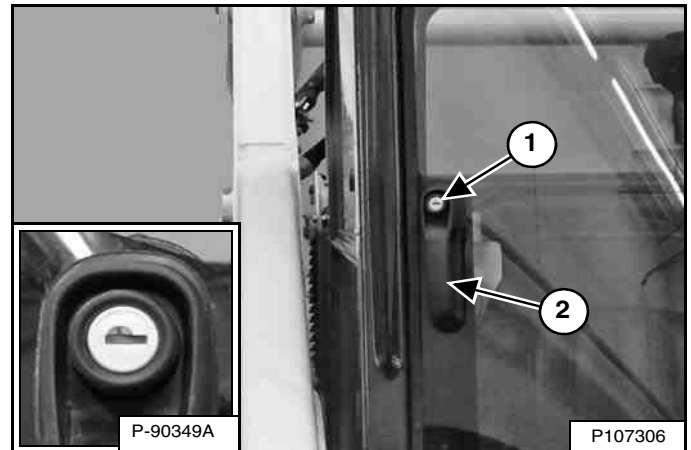

Push the knob (Item 1) and pull the handle (Item 2) to open the front door. A lock is provided in the knob (Inset [Figure 23]) to lock the front door when the loader is not in use.

Figure 24

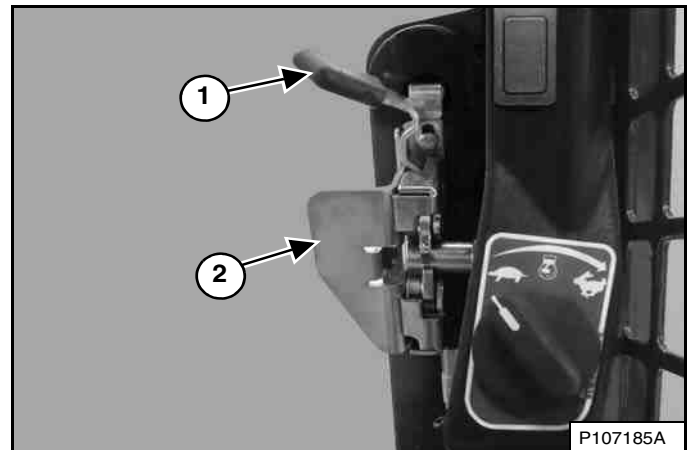

Pull the front door closed using the handle (Item 2) [Figure 24].

Pull the lever (Item 1) toward you to unlatch the front door. Push on the handle (Item 2) [Figure 24] to open the front door.

**OPERATOR CAB (CONT'D)**

**Front Wiper**

This machine may be equipped with a front wiper.

**Figure 25**

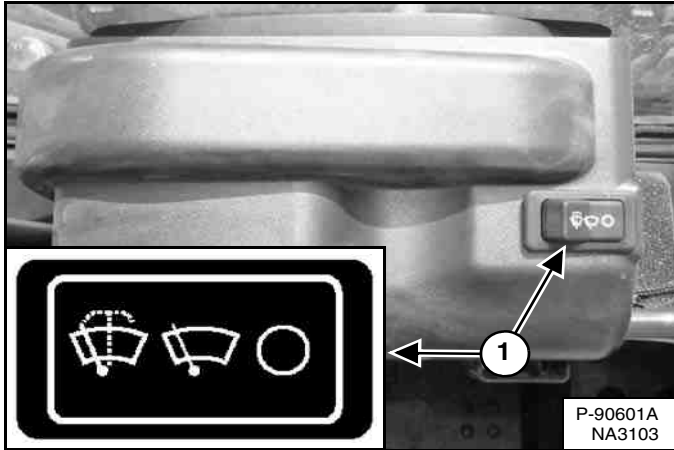

Press the left side of the switch (Item 1) [Figure 25] to start the front wiper (press and hold for washer fluid). Press the right side of the switch to stop the wiper.

**Figure 26**

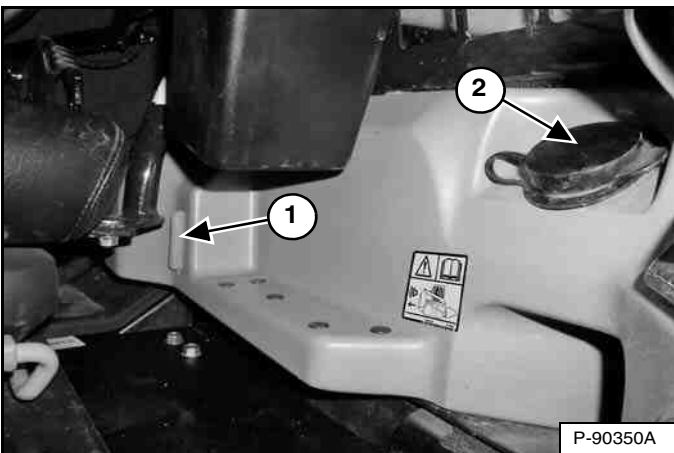

The washer fluid tank is located to the left of the operator seat. Check the fluid level in the sight gauge (Item 1). Remove the cap (Item 2) [Figure 26] to add washer fluid.

**Cab Light**

The cab light is located above the operator's left shoulder.

**Figure 27**

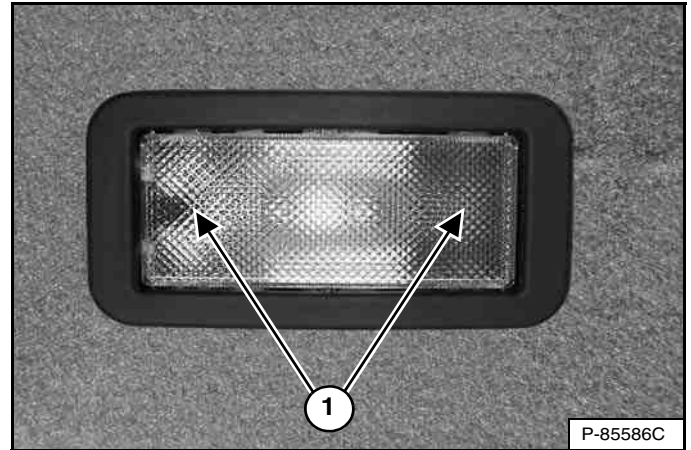

Push either side of the lens (Item 1) [Figure 27] to turn the light ON. Return the lens to the middle position to turn the light OFF.

**BOBCAT INTERLOCK CONTROL SYSTEM (BICS™)**

**Description**



**AVOID INJURY OR DEATH**

The Bobcat Interlock Control System (BICS™) must deactivate the lift, tilt and traction drive functions. If it does not, contact your dealer for service. **DO NOT** modify the system.

W-2151-1111

**Figure 28**

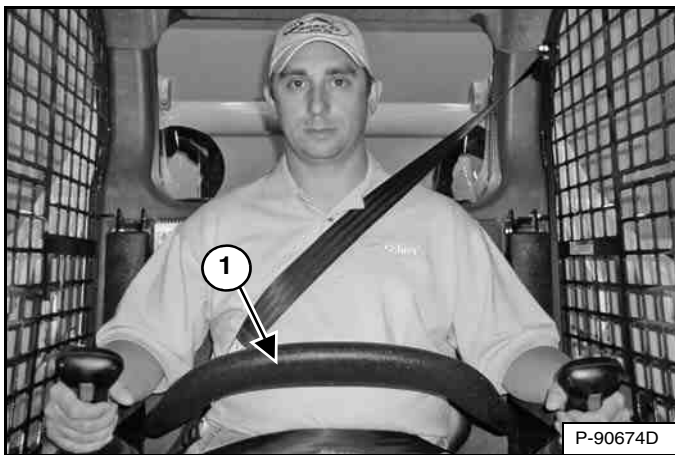

The Bobcat Interlock Control System (BICS™) has a pivoting seat bar with armrests (Item 1) [Figure 28]. The operator controls the use of the seat bar.



**AVOID INJURY OR DEATH**

**When operating the machine:**

- Keep the seat belt fastened snugly.
- The seat bar must be lowered.
- Keep your feet on the foot rests and hands on control levers.

W-2399-0501

The BICS™ requires the operator to be seated in the operating position with the seat bar fully lowered before the lift, tilt, auxiliary hydraulics, and traction drive functions can be operated. The seat belt must be fastened anytime you operate the machine.

**Operation**

**Figure 29**



There are three display lights (Items 1, 2, and 3) [Figure 29] located on the left instrument panel that must be OFF to fully operate the machine.

When the seat bar is lowered, the engine is running, the PRESS TO OPERATE LOADER button is activated, and the parking brake is released; the lift, tilt, auxiliary hydraulics, and traction drive functions can be operated.

When the seat bar is raised; the lift, tilt, auxiliary hydraulics, and traction drive functions are deactivated.



**AVOID INJURY OR DEATH**

**Before you leave the operator's seat:**

- Lower the lift arms and put the attachment flat on the ground.
- Stop the engine.
- Engage the parking brake.
- Raise the seat bar.
- Move all controls to the NEUTRAL / LOCKED position to make sure the lift, tilt and traction drive functions are deactivated.

The seat bar system must deactivate these functions when the seat bar is up. See your Bobcat dealer for service if controls do not deactivate.

W-2463-1110

## SEAT BAR RESTRAINT SYSTEM

### Description

Figure 30

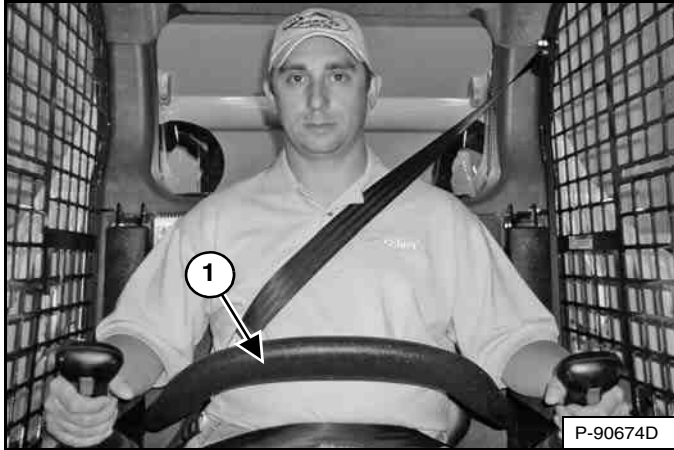

The seat bar restraint system has a pivoting seat bar with armrests (Item 1) [Figure 30].

The operator controls the use of the seat bar. The seat bar in the down position helps to keep the operator in the seat.

## WARNING

### AVOID INJURY OR DEATH

When operating the machine:

- Keep the seat belt fastened snugly.
- The seat bar must be lowered.
- Keep your feet on the foot rests and hands on control levers.

W-2399-0501

### Operation

When the seat bar is down, the engine is running, the PRESS TO OPERATE LOADER button is activated, and the brake is released; the lift, tilt, and traction drive functions can be operated.

When the seat bar is raised; the lift, tilt, and traction drive functions are deactivated.

## WARNING

### AVOID INJURY OR DEATH

Before you leave the operator's seat:

- Lower the lift arms and put the attachment flat on the ground.
- Stop the engine.
- Engage the parking brake.
- Raise the seat bar.
- Move all controls to the NEUTRAL / LOCKED position to make sure the lift, tilt and traction drive functions are deactivated.

The seat bar system must deactivate these functions when the seat bar is up. See your Bobcat dealer for service if controls do not deactivate.

W-2463-1110



## SELECTIVE CATALYTIC REDUCTION (SCR) SYSTEM

### Description



The engine exhaust system is equipped with a selective catalytic reduction (SCR) system. The SCR is an emissions reduction system that removes nitrogen oxides from the exhaust gases.

The machine will periodically perform a process to clean sulfur oxides from the SCR system. This process is called DeSOX.

The SCR system requires Diesel Exhaust Fluid (DEF) / AdBlue® to function correctly. (See DIESEL EXHAUST FLUID (DEF) / ADBLUE® SYSTEM on Page 147.)

**NOTE: Diesel exhaust fluid (DEF) and AdBlue® are different names for the same fluid. See your Bobcat dealer for more information.**

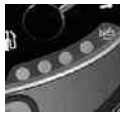
### Diesel Exhaust Fluid (DEF) / AdBlue® Level

STAGE	FLUID LEVEL	LEVEL INDICATOR	DEF / ADBLUE® MALFUNCTION ICON	DISPLAY SCREEN	ALARM	SERVICE CODES	ENGINE TORQUE DERATE	ENGINE RPM DERATE
								
	Full	Four Green Lights						
	75%	Three Green Lights						
	50%	Two Green Lights						
Warning	25% - 10%	One Green Light	On	DEF L [1]	Three Beeps	E00524617 U00176115		
Level 1	Less Than 10%	One Yellow Light	On	DEF L [1]	Three Beeps (Additional beep every 20 minutes)	E00524615 E00524617 U00176115	25%	
Level 2	Less Than 5%	One Red Light	On	DEF L [2]	Three Beeps for each code (Additional beep every 10 minutes)	E00524615 E00524616 E00524617 U00176115	50%	60%
Final	Less Than 2.5%	One Red Light	Flashing	DEF L	Three Beeps for each code (Additional beep every 2 minutes)	E00524600 E00524616 E00524617 U00176101 U00176116		Low Idle Only

[1] Pressing the information button on the left panel will return the display to the hourmeter for 20 minutes.

[2] Pressing the information button on the left panel will return the display to the hourmeter for 10 minutes.

**NOTE: The level indicator, DEF / AdBlue® malfunction icon, and display screen are located on the left panel. (See Left Panel on Page 38.)**

## SELECTIVE CATALYTIC REDUCTION (SCR) SYSTEM (CONT'D)

### DeSOX Process

There are three DeSOX processes:

- Passive DeSOX (Automatically performed by the machine unless inhibited)
- Forced DeSOX (Machine requested; operator initiated)
- Inhibit DeSOX (Option)

#### Passive DeSOX Process

**Figure 31**



The DeSOX process will begin automatically every 200 hours. The alarm will beep once and **[DESOX]** will appear in the data display **[Figure 31]**.

The display will revert to the hourmeter when the process is finished or press the information button to return to the hourmeter immediately.

The DeSOX process can last 15 minutes or longer.

It is recommended to continue operating the machine under load until the DeSOX process is finished.

If the machine is turned OFF during a passive DeSOX process, the process will resume the next time the machine is started after acceptable conditions are reached.

#### Forced DeSOX Process

The machine may request a forced DeSOX if a passive DeSOX was not finished.

**Figure 32**



The alarm will beep twice, the engine malfunction icon will light, and **[DESOX]** will flash in the data display **[Figure 32]**. Service code **[E00008107]** will also be displayed. The engine control unit (ECU) will reduce engine torque by 40%.

The operator must turn the engine speed control to the high idle position. Keep the engine speed control in the high idle position until the process is finished.

The forced DeSOX process will last 20 minutes.

It is recommended to continue operating the machine under load until the DeSOX process is finished.



## SELECTIVE CATALYTIC REDUCTION (SCR) SYSTEM (CONT'D)

### DeSOX Process (Cont'd)

#### *Inhibit DeSOX Process (Option)*

An optional kit is available from your dealer to prevent the machine from performing a DeSOX process.

**Figure 33**

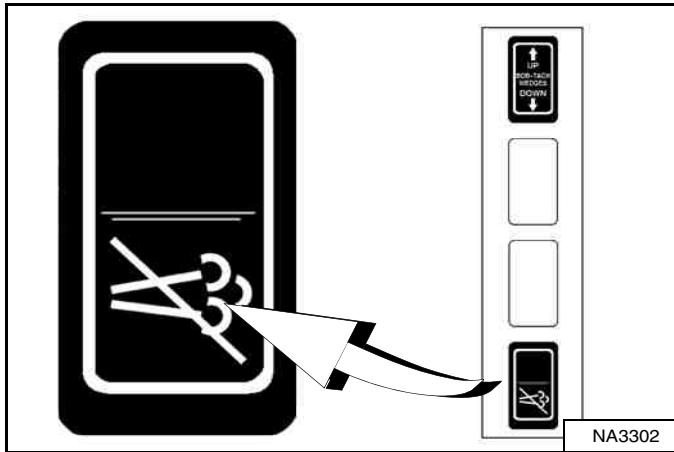

Press the bottom of the DeSOX Inhibit switch (Right Switch Panel) **[Figure 33]** to prevent the loader from performing a DeSOX process. The switch will light while DeSOX is inhibited. The inhibit will reset when the machine is turned OFF.

Press and hold the bottom of the DeSOX Inhibit switch for approximately 5 seconds to permanently prevent the loader from performing a DeSOX process. The switch will light while DeSOX is inhibited. Press and release the bottom of the DeSOX Inhibit switch to reset and allow the machine to perform a DeSOX process.

If a DeSOX process has started, pressing and holding the bottom of the DeSOX Inhibit switch for 3 seconds will stop the process.

**Figure 34**



The engine malfunction icon will light **[Figure 34]** and the alarm will beep twice if a DeSOX process is needed while inhibited. Service code **[E00008107]** will also be displayed. The engine torque will reduce by 40% if the operator continues to operate the machine while inhibited.

## SELECTIVE CATALYTIC REDUCTION (SCR) SYSTEM (CONT'D)

### SCR System Codes

The following SCR system codes alert the operator of conditions that require attention. Continued operation of the machine under these conditions will result in reduced machine performance. See your Bobcat dealer for more information.

*Diesel Exhaust Fluid (DEF) / AdBlue® Unsatisfactory Quality*

**Figure 35**



[DEF Q] will appear in the data display [Figure 35] to alert the operator that the DEF / AdBlue® quality is unsatisfactory. (See Diesel Exhaust Fluid (DEF) / AdBlue® Unsatisfactory Quality on Page 57.)

*SCR System Component Tampering*

**Figure 36**



[SCR] will appear in the data display [Figure 36] to alert the operator that an SCR system component has been tampered with. (See SCR System Component Tampering on Page 57.)

*EGR Impeded*

**Figure 37**



[EGR] will appear in the data display [Figure 37] to alert the operator that the exhaust gas recirculation (EGR) system is impeded. (See EGR Impeded on Page 58.)

*Diesel Exhaust Fluid (DEF) / AdBlue® Dosing Interruption*

**Figure 38**





[DOSE] will appear in the data display [Figure 38] to alert the operator that there has been an interruption in DEF / AdBlue® dosing. (See Diesel Exhaust Fluid (DEF) / AdBlue® Dosing Interruption on Page 58.)



**SELECTIVE CATALYTIC REDUCTION (SCR) SYSTEM (CONT'D)**

**Diesel Exhaust Fluid (DEF) / AdBlue® Unsatisfactory Quality**

The machine can detect unsatisfactory quality DEF / AdBlue® and will alert the operator.

STAGE	ENGINE MALFUNCTION ICON	DISPLAY SCREEN	ALARM	SERVICE CODES	ENGINE TORQUE DERATE	ENGINE RPM DERATE
						
Warning	On	DEF Q [1]	Three Beeps	E00524624 [3]		
Level 1	Flashing	DEF Q [1]	Three Beeps (Additional beep every 20 minutes)	E00524624 [3]	25%	
Level 2	Flashing	DEF Q [2]	Three Beeps (Additional beep every 10 minutes)	E00524624 [3]	50%	60%
Final	Flashing	DEF Q	Three Beeps (Additional beep every 2 minutes)	E00524624 [3]		Low Idle Only

[1] Pressing the information button on the left panel will return the display to the hourmeter for 20 minutes.

[2] Pressing the information button on the left panel will return the display to the hourmeter for 10 minutes.

[3] Also code U00351600, U00351601, or U00351631 will be displayed.

**NOTE: The engine malfunction icon and display screen are located on the left panel. (See Left Panel on Page 38.)**

**SCR System Component Tampering**

The machine can detect tampering with SCR system components and will alert the operator.

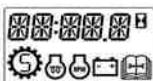
STAGE	ENGINE MALFUNCTION ICON	DISPLAY SCREEN	ALARM	SERVICE CODES	ENGINE TORQUE DERATE	ENGINE RPM DERATE
						
Warning	On	SCR [1]	Three Beeps	E00524625 [3]		
Level 1	Flashing	SCR [1]	Three Beeps (Additional beep every 20 minutes)	E00524625 [3]	25%	
Level 2	Flashing	SCR [2]	Three Beeps (Additional beep every 10 minutes)	E00524625 [3]	50%	60%
Final	Flashing	SCR	Three Beeps (Additional beep every 2 minutes)	E00524625 [3]		Low Idle Only

[1] Pressing the information button on the left panel will return the display to the hourmeter for 20 minutes.

[2] Pressing the information button on the left panel will return the display to the hourmeter for 10 minutes.

[3] One or more 'U' codes could also be displayed.



**NOTE: The engine malfunction icon and display screen are located on the left panel. (See Left Panel on Page 38.)**



**SELECTIVE CATALYTIC REDUCTION (SCR) SYSTEM (CONT'D)**

**EGR Impeded**

The machine can detect an impeded exhaust gas recirculation (EGR) system and will alert the operator.

STAGE	ENGINE MALFUNCTION ICON	DISPLAY SCREEN	ALARM	SERVICE CODES	ENGINE TORQUE DERATE	ENGINE RPM DERATE
						
Warning	On	EGR [1]	Three Beeps	E00524621 [3]		
Level 1	Flashing	EGR [1]	Three Beeps (Additional beep every 20 minutes)	E00524621 [3]	25%	
Level 2	Flashing	EGR [2]	Three Beeps (Additional beep every 10 minutes)	E00524621 [3]	50%	60%
Final	Flashing	EGR	Three Beeps (Additional beep every 2 minutes)	E00524621 [3]		Low Idle Only

[1] Pressing the information button on the left panel will return the display to the hourmeter for 20 minutes.

[2] Pressing the information button on the left panel will return the display to the hourmeter for 10 minutes.

[3] Also code U06522621. Additional 'E' codes could also be displayed.

**NOTE: The engine malfunction icon and display screen are located on the left panel. (See Left Panel on Page 38.)**

**Diesel Exhaust Fluid (DEF) / AdBlue® Dosing Interruption**

The machine can detect an interruption in DEF / AdBlue® dosing and will alert the operator.

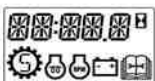
STAGE	ENGINE MALFUNCTION ICON	DISPLAY SCREEN	ALARM	SERVICE CODES	ENGINE TORQUE DERATE	ENGINE RPM DERATE
						
Warning	On	DOSE [1]	Three Beeps	E00524622 [3]		
Level 1	Flashing	DOSE [1]	Three Beeps (Additional beep every 20 minutes)	E00524622 [3]	25%	
Level 2	Flashing	DOSE [2]	Three Beeps (Additional beep every 10 minutes)	E00524622 [3]	50%	60%
Final	Flashing	DOSE	Three Beeps (Additional beep every 2 minutes)	E00524622 [3]		Low Idle Only

[1] Pressing the information button on the left panel will return the display to the hourmeter for 20 minutes.

[2] Pressing the information button on the left panel will return the display to the hourmeter for 10 minutes.

[3] One or more 'U' codes could also be displayed.

**NOTE: The engine malfunction icon and display screen are located on the left panel. (See Left Panel on Page 38.)**

## PARKING BRAKE

### Operation

Figure 39



Press the top of the switch (Item 1) [Figure 39] to engage the parking brake. The red light in the switch will turn ON. The traction drive system is locked.

Move joystick(s) slowly forward and backward. The TRACTION lock must be engaged. See your Bobcat dealer for service if loader fails to stop.

Press the bottom of the switch (Item 2) [Figure 39] to disengage the parking brake. The red light in the switch will turn OFF. The traction drive system is unlocked.

**NOTE:** The PARKING BRAKE light on the left instrument panel will remain ON until the engine is started, the PRESS TO OPERATE LOADER button is pressed, and the parking brake is disengaged.

## TRACTION LOCK OVERRIDE

### Description

Figure 40



(Functions Only When The Seat Bar Is Raised And The Engine Is Running) There is a TRACTION LOCK OVERRIDE button (Item 1) [Figure 40] on the left instrument panel that will allow you to use the steering controls to move the loader forward and backward when using the backhoe attachment.

### Operation

Press the TRACTION LOCK OVERRIDE button once to unlock traction drive. The PARKING BRAKE light (Item 2) [Figure 40] is OFF.

Press the button a second time to lock the traction drive. The PARKING BRAKE light (Item 2) [Figure 40] is ON.

**NOTE:** The TRACTION LOCK OVERRIDE button will unlock the traction drive when the seat bar is raised and the engine is running.

**NOTE:** The TRACTION LOCK OVERRIDE button will function if the parking brake is in the engaged or disengaged position and the engine is running. If the Parking Brake switch is turned ON, the red light in the Parking Brake switch will turn OFF when TRACTION LOCK OVERRIDE is engaged.

## ENGINE SPEED CONTROL

### Operation

Figure 41

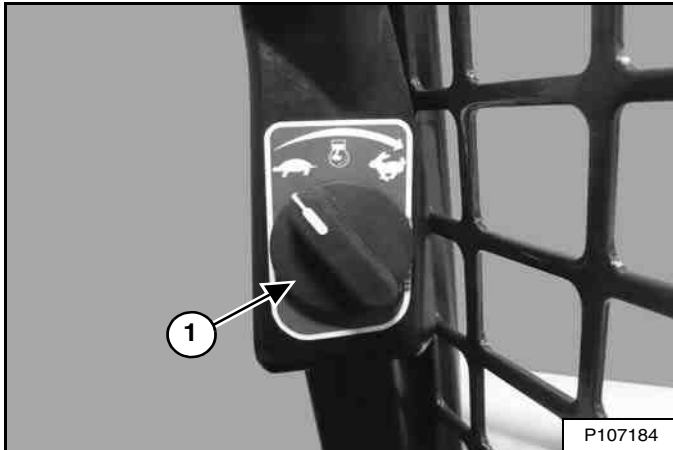

The engine speed control (Item 1) [Figure 41] is located alongside the door frame below the right panel.

Turn the knob clockwise to increase engine speed. Turn the knob anticlockwise to decrease engine speed.

**NOTE:** The full range of the engine speed control will not be available until the engine controller determines the engine is adequately warmed.

Figure 42

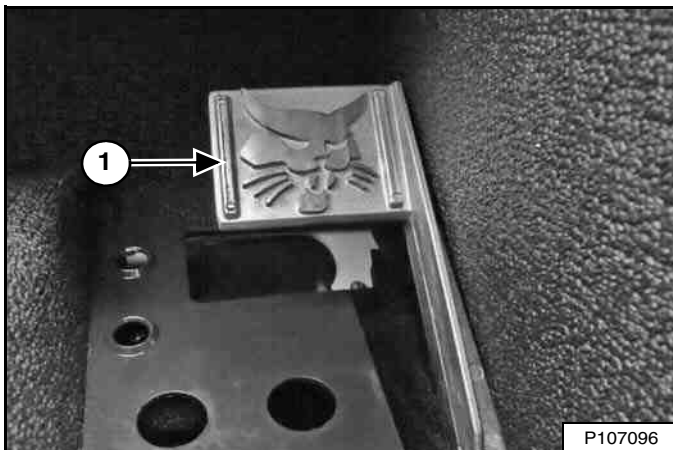

This machine has a foot operated engine speed control pedal (Item 1) [Figure 42] in addition to the engine speed control knob. The pedal is located on the right side floor above the footrest.

## AUTO IDLE

### Description

The auto idle feature (when engaged) reduces the engine speed to low idle when the joysticks are in NEUTRAL and not used for approximately five seconds.

All of the following conditions / actions must be met to allow the engine speed to reduce to low idle when auto idle is ON:

- Joysticks are not moved out of NEUTRAL.
- Auxiliary hydraulics is not engaged.
- Foot operated engine speed control pedal is not depressed.
- Engine speed controls are not moved.

Any of the following conditions / actions return the engine speed to the set position from low idle:

- Moving a joystick out of NEUTRAL.
- Engaging auxiliary hydraulics.
- Moving either engine speed control.

**NOTE:** The five second time delay before the engine speed reduces to low idle can be changed on machines equipped with a Deluxe Instrumentation Panel. (See Auto Idle Time Delay on Page 206.)

### Operation

Figure 43



Press the button (Item 2) to engage auto idle. The light (Item 1) [Figure 43] is ON.

Press the button again to disengage auto idle. The light is OFF.

**NOTE:** Always disengage the auto idle feature when loading or unloading the loader on a trailer.

## LIFT ARM BYPASS CONTROL

### Description

Figure 44

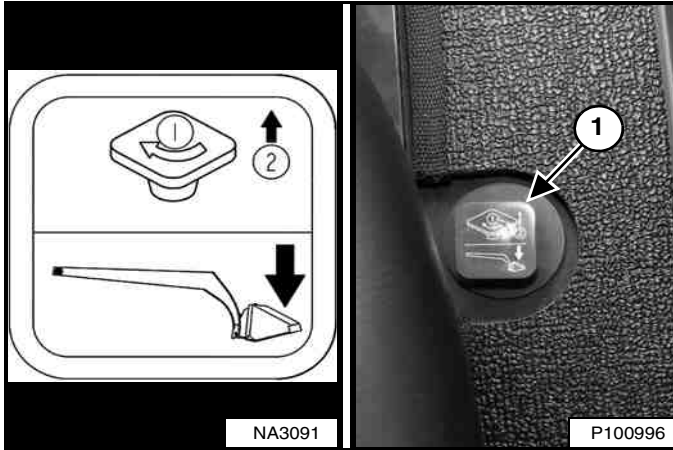

The lift arm bypass control (Item 1) [Figure 44], located to the right of the operator's seat, is used to lower the lift arms if the lift arms cannot be lowered during normal operations.

### Operation

Perform the procedure below to operate the lift arm bypass control:

1. Sit in the operator's seat.
2. Fasten the seat belt and lower the seat bar.
3. Turn the knob (Item 1) [Figure 44] 90° clockwise.
4. Pull up and hold the knob until the lift arms lower.

## EMERGENCY EXIT

The front opening on the operator cab and rear window provide exits.

### Rear Window Identification

Figure 45

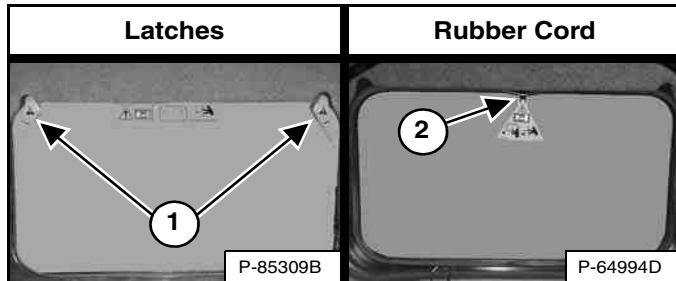

There are two different procedures for removing the rear window from your machine:

1. This window is equipped with latches [Figure 45].
2. This window is equipped with a rubber cord and tag [Figure 45].

**NOTE:** Use these procedures to remove the rear window only under emergency conditions. Damage to machine may occur.

### Rear Window Removal (Latches)

Figure 46

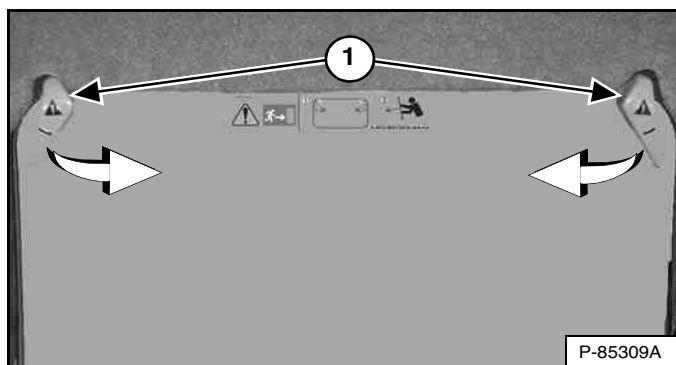

Turn both latches (Item 1) [Figure 46] in until they disengage from the window frame.

Push the rear window out of the rear of the operator cab.

Figure 47



Exit through the rear of the operator cab [Figure 47].

### Rear Window Removal (Rubber Cord)

Figure 48



Pull on the tag on the top of the rear window to remove the rubber cord [Figure 48].

Push the rear window out of the rear of the operator cab.

Figure 49



Exit through the rear of the operator cab [Figure 49].



## EMERGENCY EXIT (CONT'D)

### External Access (Rear Window With Latches)

Figure 50

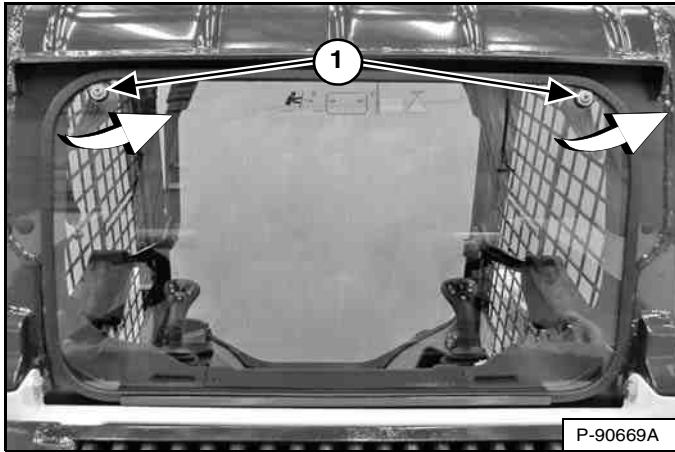

The rear window can be removed from outside the loader using a T40 TORX® Drive tool. Turn both screws (Item 1) [Figure 50] anticlockwise until the latches disengage from the window frame. Pull the top of the window away from the cab and lift up to remove.

OR

Figure 51

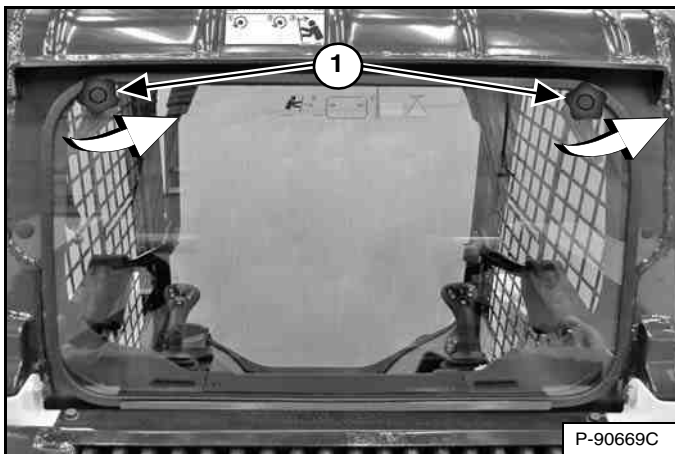

A kit is available to allow removal of the latch equipped rear window from outside the machine without tools. See your Bobcat dealer for availability.

Turn both knobs (Item 1) [Figure 51] anticlockwise until the latches disengage from the window frame. Pull the top of the window away from the cab and lift up to remove.

### External Access (Rear Window With Rubber Cord)

A kit is available to allow removal of the rubber cord equipped rear window from outside the machine. See your Bobcat dealer for availability.

Figure 52

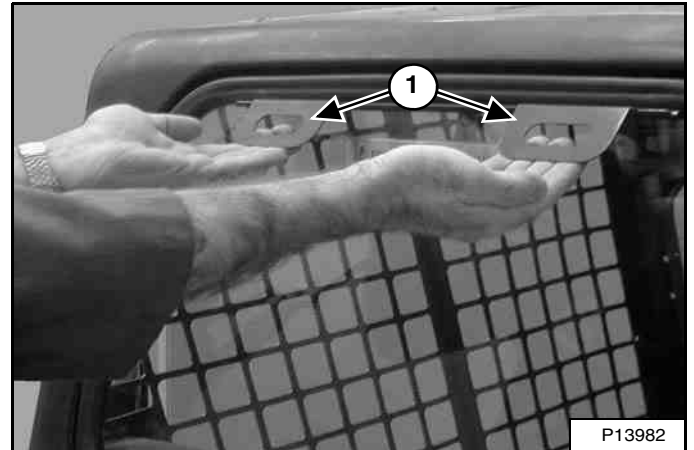

Pull both handles (Item 1) [Figure 52] up and out to remove the rear window.

### Front Door

**NOTE:** Use this procedure to remove the front door only under emergency conditions. Damage to machine may occur.

Figure 53

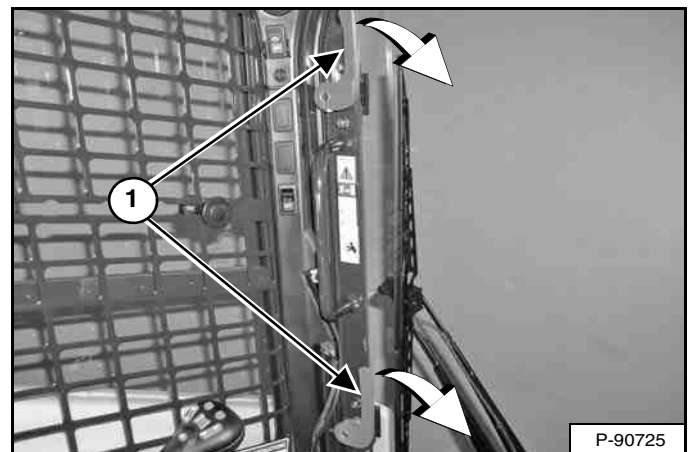

Turn both latches (Item 1) [Figure 53] down until they disengage from the door frame.

Push the door out of the operator cab door frame and exit through the opening.

**EMERGENCY EXIT (CONT'D)**

**Front Door (Cont'd)**

*Front Door Reassembly*

Reassemble the front door using the following instructions if the door was opened using the emergency exit procedure.

**Figure 54**

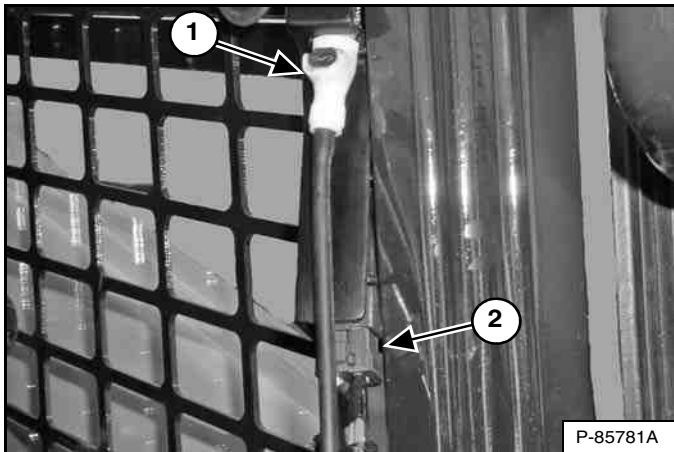

**NOTE:** Later models route the washer fluid hose differently and will not require this step.

Disconnect electrical connector (Item 2) and washer fluid hose (Item 1) (if equipped) [Figure 54].

**Figure 55**

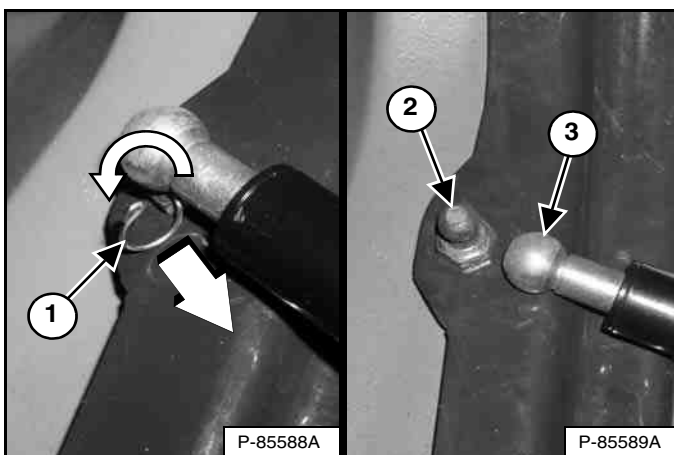

Rotate and pull the clip (Item 1) out of the gas spring socket. Pull the gas spring socket (Item 3) straight off the ball stud fitting (Item 2) [Figure 55].

Remove the door hinges from the loader.

**Figure 56**

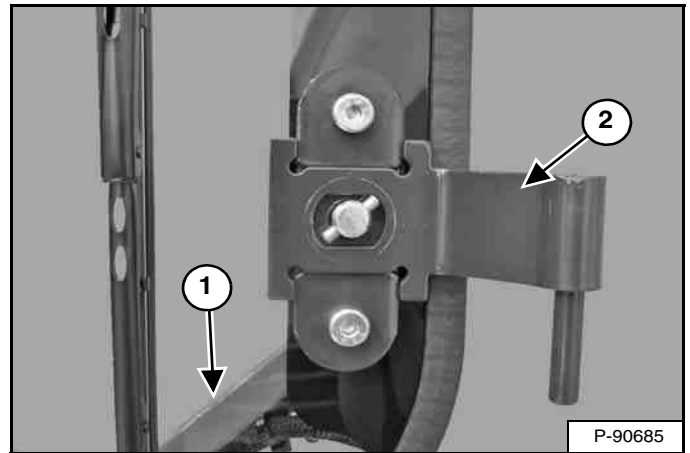

Orient the latches as shown (Item 1) and install the door hinges (Item 2) [Figure 56] on the door. (Bottom hinge shown.)

**Figure 57**

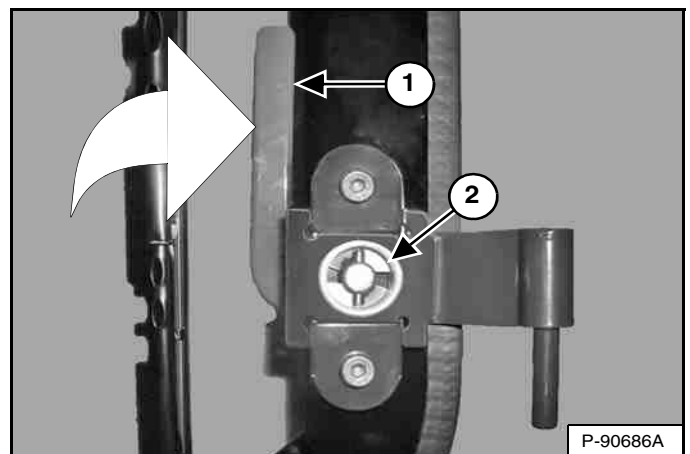

Install cast washers (Item 2) on door hinges taking care to match rectangular surfaces. Hold cast washer firmly against door and rotate latch (Item 1) [Figure 57] up to lock cast washer into position. (Bottom hinge shown.) (Plastic cap shown removed for visual clarity.)

Install door on loader. Install the gas spring socket on the ball stud fitting. Install the clip into the hole in the gas spring socket. Rotate the clip to lock into position [Figure 55].

Connect electrical connector and washer fluid hose (if equipped) [Figure 54].

## BACK-UP ALARM SYSTEM

This machine may be equipped with a back-up alarm.

### Description

Figure 58

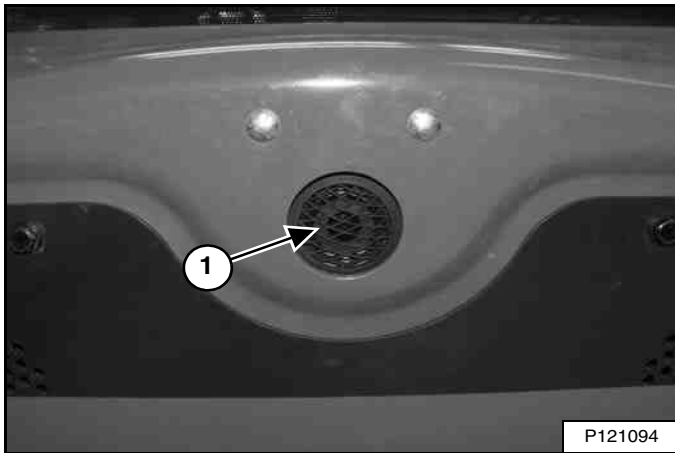

The back-up alarm (Item 1) [Figure 58] is located on the inside of the rear door.

**A back-up alarm is not a substitute for looking to the rear when operating the loader in reverse, or for keeping bystanders away from the work area.** Operators **must always** look in the direction of travel, including **reverse**, and must also keep bystanders away from the work area, even though the loader is equipped with a back-up alarm.

Operators must be trained to **always** look in the direction of travel, **including when operating the loader in reverse** and to keep bystanders away from the work area. Other workers should be trained to **always** keep away from the operator's work area and travel path.

### Operation

## WARNING

### AVOID INJURY OR DEATH

- Always keep bystanders away from the work area and travel path.
- The operator must always look in the direction of travel.
- The back-up alarm must sound when operating the machine in the reverse direction.

W-2783-0409

The back-up alarm will sound when the operator moves the joystick(s) into the reverse position. Slight movement of the joystick(s) into the reverse position is required with hydrostatic transmissions, before the back-up alarm will sound.

If alarm does not sound, see inspection and maintenance instructions for the back-up alarm system in the preventive maintenance section of this manual. (See BACK-UP ALARM SYSTEM on Page 132.)

**DRIVING AND STEERING THE LOADER**  
**Operation (SJC) In 'ISO' Control Pattern**

Figure 59

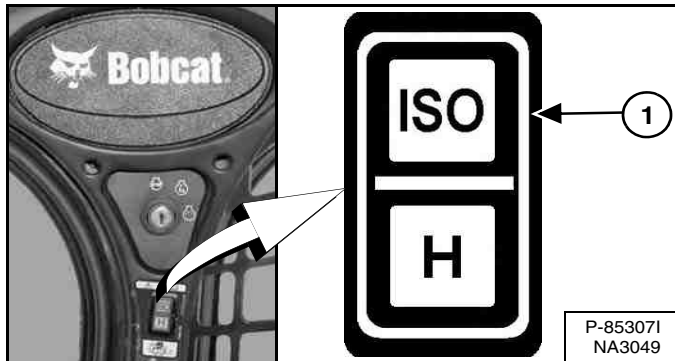

Select the 'ISO' control pattern by pressing the top of the switch (Item 1) [Figure 59].



**AVOID INJURY OR DEATH**

When operating the machine:

- Keep the seat belt fastened snugly.
- The seat bar must be lowered.
- Keep your feet on the foot rests and hands on control levers.

W-2399-0501

Figure 60



The joystick that controls drive and steering is on the left side in front of the seat (Item 1) [Figure 60].

Move the joystick smoothly. Avoid sudden starting and stopping.

Figure 61

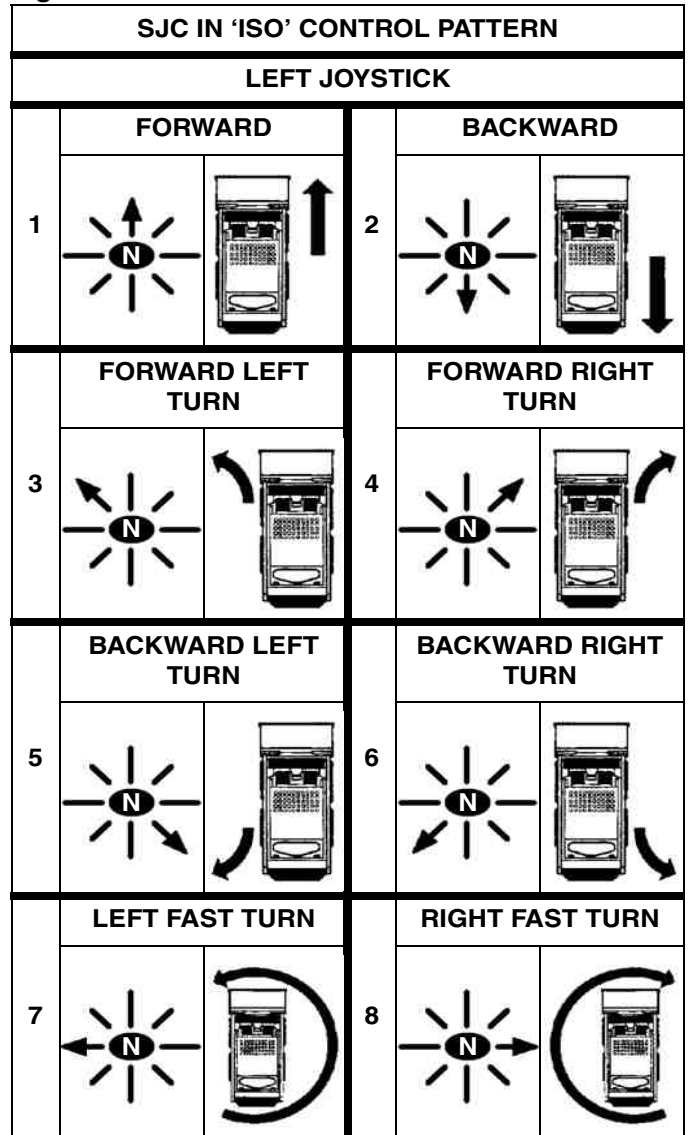

*Left Joystick Functions (Drive And Steering) [Figure 61]:*

1. **Forward Travel** – Move joystick forward.
2. **Backward Travel** – Move joystick backward.
3. **Forward Left Turn** – Move joystick forward and to the left.
4. **Forward Right Turn** – Move joystick forward and to the right.
5. **Backward Left Turn** – Move joystick backward and to the left.
6. **Backward Right Turn** – Move joystick backward and to the right.
7. **Left Fast Turn** – Move joystick to the left.
8. **Right Fast Turn** – Move joystick to the right.

DRIVING AND STEERING THE LOADER (CONT'D)

Operation (SJC) In 'H' Control Pattern

Figure 62

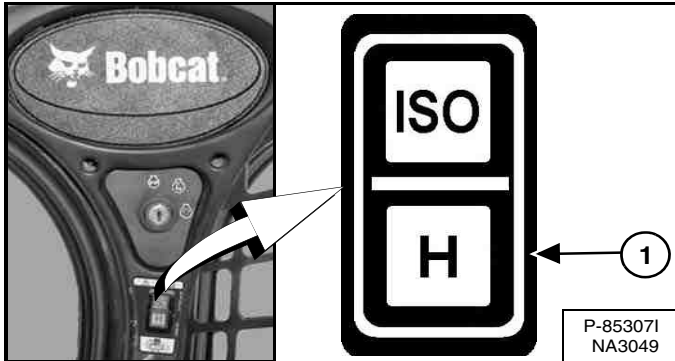

Select the 'H' control pattern by pressing the bottom of the switch (Item 1) [Figure 62].



AVOID INJURY OR DEATH

When operating the machine:

- Keep the seat belt fastened snugly.
- The seat bar must be lowered.
- Keep your feet on the foot rests and hands on control levers.

W-2399-0501

Figure 63

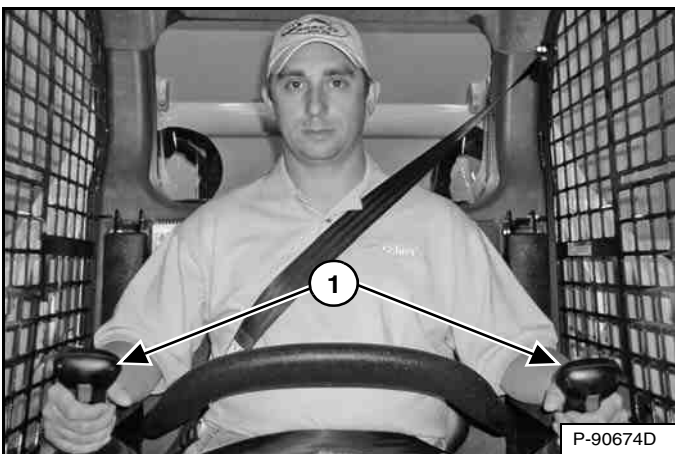

Both joysticks control drive and steering and are located on the left and right side in front of the seat (Item 1) [Figure 63].

Move the joysticks smoothly. Avoid sudden starting and stopping.

Figure 64

SJC IN 'H' CONTROL PATTERN				
	LEFT JOYSTICK	RIGHT JOYSTICK		
1				FORWARD
2				BACKWARD
3				LEFT TURN
4				RIGHT TURN
5				LEFT FAST TURN
6				RIGHT FAST TURN

Joystick Functions (Drive And Steering) [Figure 64]:

1. **Forward Travel** – Move both joysticks forward.
2. **Backward Travel** – Move both joysticks backward.
3. **Forward Left Turn** – Move the right joystick farther forward than the left joystick.
4. **Forward Right Turn** – Move the left joystick farther forward than the right joystick.
5. **Left Fast Turn** – Move the left joystick backward and the right joystick forward.
6. **Right Fast Turn** – Move the left joystick forward and the right joystick backward.



## STOPPING THE LOADER

### Using The Joysticks

When the joysticks are moved to the NEUTRAL position, the hydrostatic transmission will act as a *service brake* to stop the loader.

## TWO-SPEED CONTROL

### Description

This machine is equipped with two speed ranges, high and low. High range allows you to reduce cycle times when there is a long travel distance between the dig site and the dump site. You can also use the high range when travelling from one jobsite to another at faster speeds.



**HITTING OBSTRUCTIONS AT HIGH RANGE SPEEDS CAN CAUSE SERIOUS INJURY OR DEATH**  
Fasten shoulder belt for additional restraint when operating at high range speeds.

W-2754-0908

Figure 65

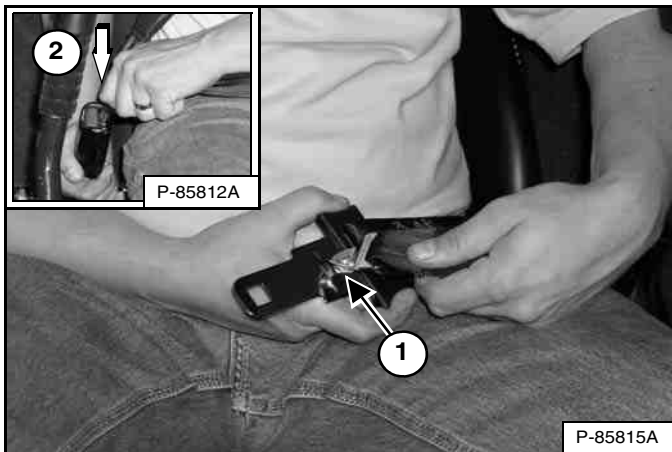

**NOTE: The 3-point restraint must be used when selecting high range operation [Figure 65].**

Connect the shoulder belt to the lap belt (Item 1). Pull the lap belt across to the right side of the seat and fasten (Item 2) [Figure 65].

The shoulder belt must be positioned over your left shoulder and lap belt over your lower hips.

### Operation

Figure 66

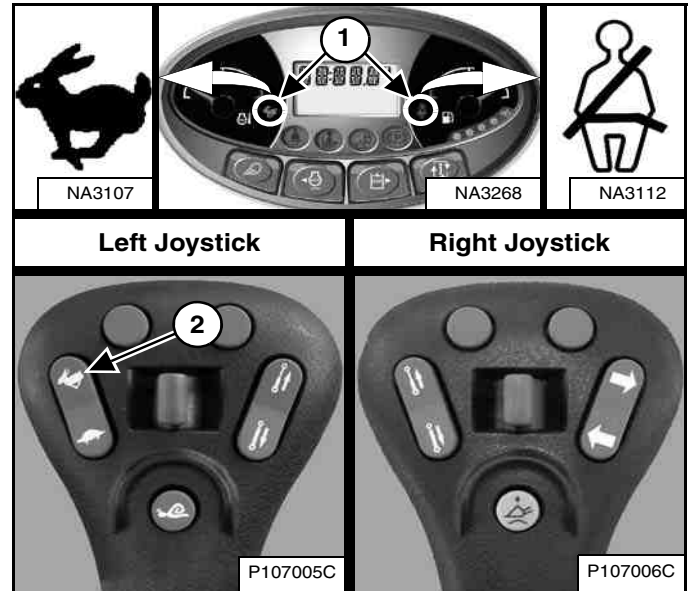

**NOTE: You must disengage Speed Management before you can select high range.**

Press the top of the switch (Item 2) on the left joystick for high range. The two-speed and shoulder belt icons located on the left instrument panel (Item 1) [Figure 66] will come on.

Press the bottom of the switch for low range.

## SPEED MANAGEMENT

### Description

Speed Management allows the loader to be manoeuvred at a slower travel speed, even during maximum movement of the joystick(s).

This feature can be useful when installing attachments, loading or unloading, and certain applications. (EXAMPLES: Landscaping, tilling, trenching)

### Operation

**NOTE: You must be in low range speed to engage Speed Management.**

Figure 67

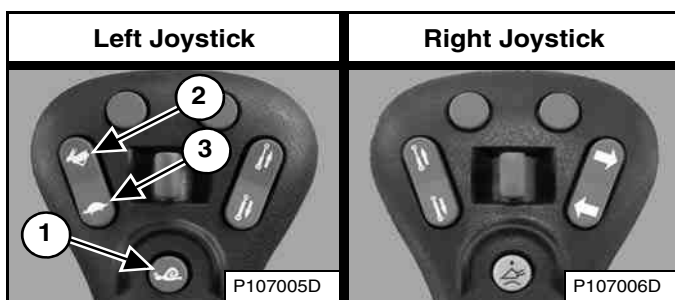

Press the button (Item 1) [Figure 67] on the left joystick once to engage Speed Management.

Figure 68

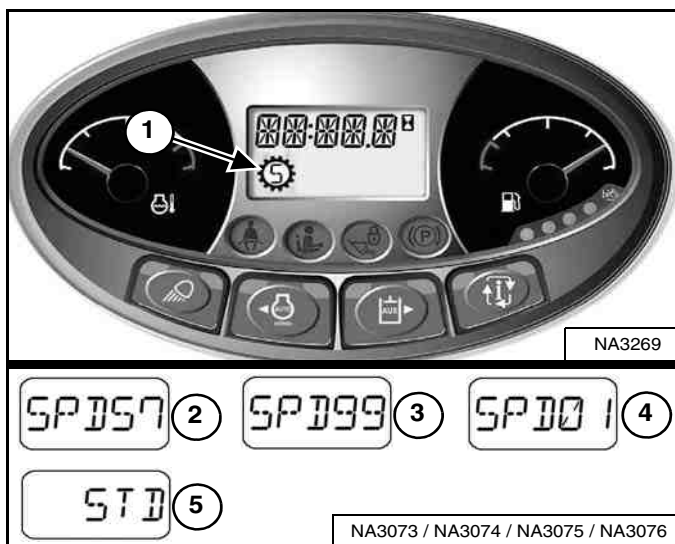

The Speed Management icon (Item 1) [Figure 68] will appear in the display and remain on until the Speed Management button is pressed again or the machine is turned off.

When Speed Management is engaged, the machine will travel at the factory default setting of 57% of Standard Travel Speed and the percentage [SPD 57] will appear in the display (Item 2) [Figure 68].

**NOTE: The factory default setting can be changed by the operator. (See Changing The Factory Default Setting on Page 71.)**

While Speed Management is engaged, press the top of the Speed Control switch (Item 2) [Figure 67] to increase the speed up to 99% [SPD 99] or the bottom of the switch (Item 3) [Figure 67] to decrease the speed down to 1% [SPD 01]. The percentages will appear in the display (Items 2, 3, and 4) [Figure 68].

Press button (Item 1) [Figure 67] again to disengage Speed Management and return to Standard Travel Speed. [STD] (Item 5) [Figure 68] will appear in the display.

The system will retain the speed percentage as long as the loader remains ON.

**EXAMPLE: You can be using the machine at 40%, then disengage Speed Management to reposition the loader, and then reengage Speed Management. The speed percentage will still be at 40%.**

**EXAMPLE: Turning the key switch to STOP will return the Speed Management setting to default. The next time you start the engine and engage Speed Management, the speed is set at 57% (factory default setting) or the last default setting saved by the operator. (See Changing The Factory Default Setting on Page 71.)**

**NOTE: You must disengage Speed Management before you can select high range.**



## SPEED MANAGEMENT (CONT'D)

### Changing The Factory Default Setting

The Speed Management factory default setting can be changed by the operator to save adjustment time.

**EXAMPLE:** Your machine is often used for trenching and you prefer a Speed Management setting of 28% of Standard Travel Speed for that application. The Speed Management default setting can be changed to 28% of Standard Travel Speed instead of the factory default setting of 57%. Each time you start the machine and first select Speed Management, the machine will default to 28% of Standard Travel Speed.

Engage Speed Management. (See Operation on Page 70.)

Figure 69

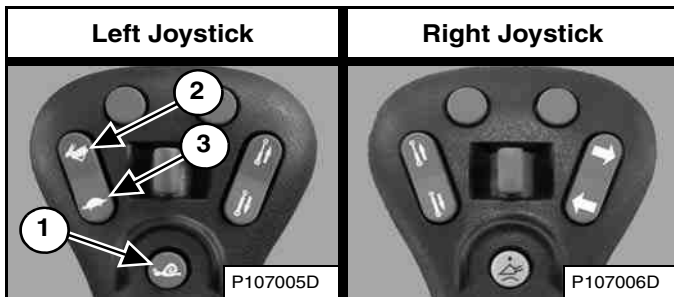

Adjust the speed percentage higher (Item 2) or lower (Item 3) [Figure 69] by pressing the Speed Control switch until the desired default setting is displayed.

Press and hold the button (Item 1) [Figure 69] on the left joystick to save the default setting.

Figure 70



The alarm will beep once, display [SET ##] [Figure 70] (## will indicate the percentage you selected) and remain in Speed Management mode.

Pressing the button (Item 1) [Figure 69] on the left joystick or turning the machine off will disengage Speed Management and return the loader to Standard Travel Speed.

When Speed Management is first selected each time the machine is started, the percentage you selected is the default setting. Speed Management can still be adjusted from 1% to 99% of Standard Travel Speed.

The default setting can be changed any time the operator chooses.



## DRIVE RESPONSE

### Description

Drive Response changes how responsive (more or less) the loaders drive and steering systems are when the operator moves the joystick(s).

Drive Response can be changed by the operator for different drive response preferences, various job conditions, and attachment use.

**NOTE: Changes to drive response do not affect braking or stopping the loader.**

There are three drive response settings:

- **[DR-1]** provides a smooth responsive reaction to joystick movement. (Drive only)
- **[DR-2]** is the default setting and provides a normal responsive reaction to joystick movement. (Drive only)
- **[DR-3]** provides a quick responsive reaction to joystick movement. (Drive only)

### Operation

Perform PRE-STARTING PROCEDURE and STARTING THE ENGINE procedures:

1. Fasten seat belt.
2. Lower seat bar.
3. Put joysticks in NEUTRAL position.
4. Start the engine.
5. Press the PRESS TO OPERATE LOADER button.
6. Current drive response setting is displayed briefly in the data display.

## DRIVE RESPONSE (CONT'D)

### Operation (Cont'd)

Figure 71

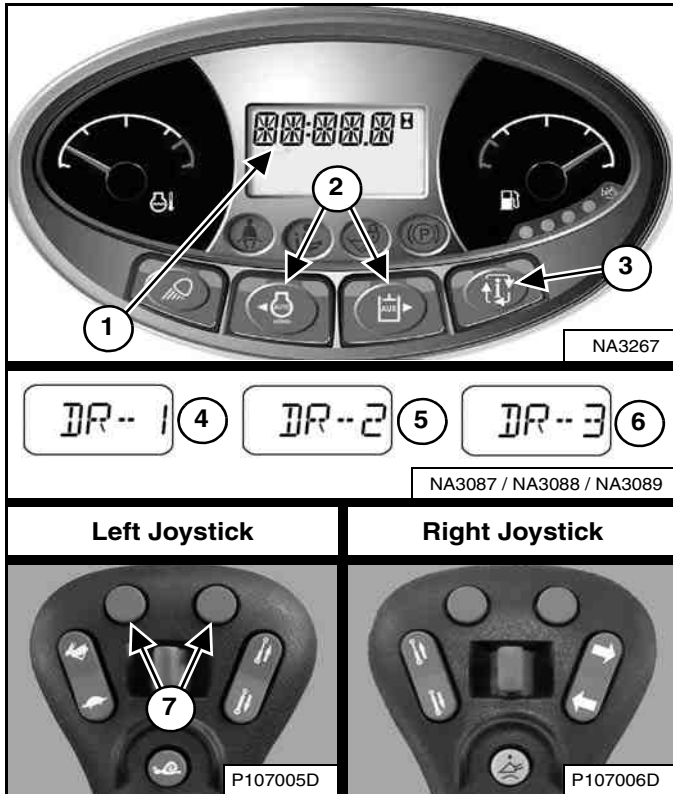

Press the Information button (Item 3) to cycle the data display until the drive response menu is displayed. The current drive response setting will appear in the data display (Item 1) [Figure 71].

Press the left or right scroll button (Item 2) [Figure 71] on the left panel to adjust the setting. Adjustments to the drive response are effective immediately.

**OR**

Press the left or right button (Item 7) [Figure 71] on the left joystick to adjust the setting. Adjustments to the drive response are effective immediately.

Press the left scroll button on the left panel or the left button on the left joystick to scroll down through the three drive response settings (Items 4, 5, and 6). Press the right scroll button on the left panel or the right button of the left joystick to scroll up through the three drive response settings (Items 4, 5, and 6) [Figure 71].

### Saving The Drive Response Setting:

The current drive response setting can be saved by pressing the Information button (Item 3) [Figure 71] to exit from the drive response adjustment menu.

**OR**

If no buttons are pressed for 10 seconds, the drive response setting will be saved and the display screen will change to the hourmeter.

**NOTE:** Machines equipped with a Deluxe Instrumentation Panel will save the drive response setting for each user. Example: If user 1 saves the setting [DR-2], the machine will be in [DR-2] the next time user 1 password is entered.

## STEERING DRIFT COMPENSATION

### Description

Steering Drift Compensation can be used to reduce steering drift to maintain a desired travel path in forward and reverse directions.

Examples of applications where this feature can be used:

- To compensate for normal variations such as track tension and track wear.
- Using side shift attachments such as trenchers, planers, and silt fence installers.
- Driving on uneven terrain such as crowned road surfaces.

### Operation

Perform PRE-STARTING PROCEDURE and STARTING THE ENGINE procedures:

1. Fasten seat belt.
2. Lower seat bar.
3. Put joysticks in NEUTRAL position.
4. Start the engine.
5. Press the PRESS TO OPERATE LOADER button.
6. Current drive response setting is displayed briefly in the data display.

Figure 72

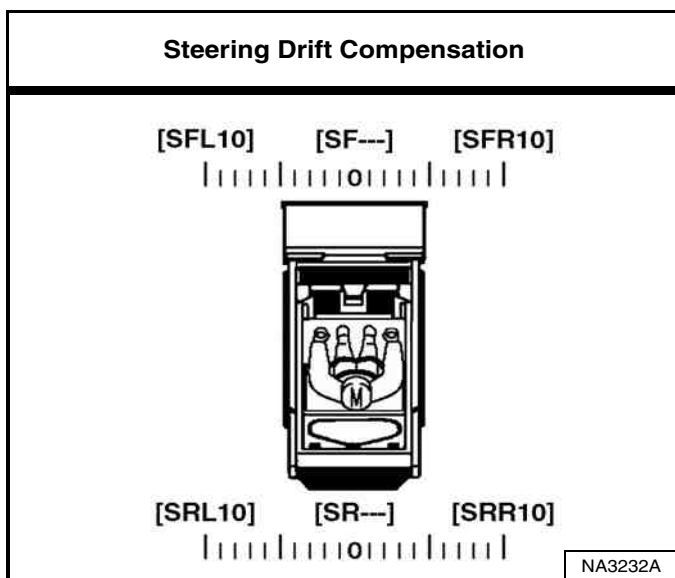

Steering drift compensation contains a total of 21 settings. Steering drift compensation can be set to any point from NEUTRAL to [SFL10] or [SRL10] left, and from NEUTRAL to [SFR10] or [SRR10] right. [SF---] or [SR---] is displayed when set for NEUTRAL [Figure 72].

## STEERING DRIFT COMPENSATION (CONT'D)

### Operation (Cont'd)

**Figure 73**

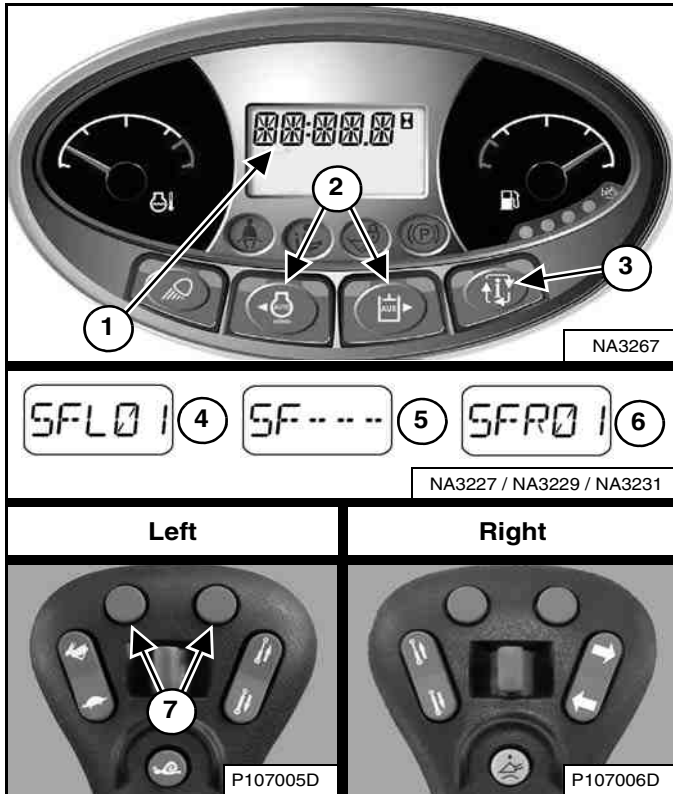

Press the Information button (Item 3) to cycle the data display until the steering drift compensation menu is displayed. The current steering drift compensation setting will appear in the data display (Item 1) [Figure 73].

Press the left or right scroll button (Item 2) [Figure 73] on the left panel to adjust the setting. Adjustments to steering drift compensation are effective immediately and saved automatically.

#### OR

Press the left or right button (Item 7) [Figure 73] on the left control to adjust the setting. Adjustments to the steering drift compensation are effective immediately and saved automatically.

Press the left scroll button on the left panel or the left button on the left control to adjust the machine left. [SFL01] (Item 4) through a maximum of [SFL10] will appear in the data display (Item 1) [Figure 73]. The number will increase by one each time you press the button. The higher the number, the greater the amount of steering drift compensation to the left.

Press the right scroll button on the left panel or the right button on the left control to adjust the machine back toward centre. The display will decrease down to NEUTRAL displayed as [SF---] (Item 5). Another press of the upper right button will cause [SFR01] (Item 6) to appear in the data display (Item 1) [Figure 73]. The number will increase by one each time you press the button up to a maximum of [SFR10]. The higher the number, the greater the amount of steering drift compensation to the right.

Forward steering drift compensation setting can be adjusted with the steering controls in NEUTRAL or during forward travel. Reverse steering drift compensation setting can be adjusted during reverse travel. The letter [R] will appear in place of the letter [F] in the data display when setting reverse steering drift compensation. (EXAMPLES: [SRL01], [SRR01], and [SR---].

#### *Exiting The Steering Drift Compensation Menu:*

Press the Information button (Item 3) [Figure 73] to exit from the steering drift compensation adjustment menu.

#### OR

If no buttons are pressed for 10 seconds, the display screen will change to the hourmeter.



## LIFT AND TILT COMPENSATION

### Description

Lift and Tilt Compensation can be used to adjust the lift and tilt control sensitivity. This enables the operator to increase or decrease the amount of control movement before lift up, lift down, tilt back, and tilt out begins. The operator can change each setting to their preference.

**EXAMPLE: Your machine is being used with a mower attachment. The mower slowly lowers because you move the controls slightly when passing over extremely rough ground. Adjusting the lift down control to a low setting will provide an increased NEUTRAL band and allow for more control movement before the lift arms move.**

The procedure that follows provides a starting point for the lift and tilt control compensation. Operators can adjust the settings to account for attachment weight, engine rpm and application.

### Operation

**NOTE: Lift and Tilt Compensation should be performed when the machine has been warmed to operating temperature and any attachment has been removed.**

Perform PRE-STARTING PROCEDURE and STARTING THE ENGINE procedures:

1. Fasten seat belt.
2. Lower seat bar and engage the parking brake.
3. Put joysticks in NEUTRAL position.
4. Start the engine.
5. Select 'H' control pattern.
6. Press the PRESS TO OPERATE LOADER button.
7. Raise the lift arms approximately 1 m (3 ft) off the ground and tilt the Bob-Tach frame forward approximately 300 mm (1 ft).
8. Raise and lower the seat bar to engage the interlocks and enable the procedure to be performed.
9. Increase engine speed to high idle.

**NOTE: When the procedure has begun, raising the seat bar will cause the machine to disengage from lift and tilt compensation. Changes made to the lift and tilt compensation settings will NOT be saved.**

## LIFT AND TILT COMPENSATION (CONT'D)

### Operation (Cont'd)

This procedure is described using the 'H' control pattern. The procedure can be performed using the 'ISO' control pattern.

Figure 74

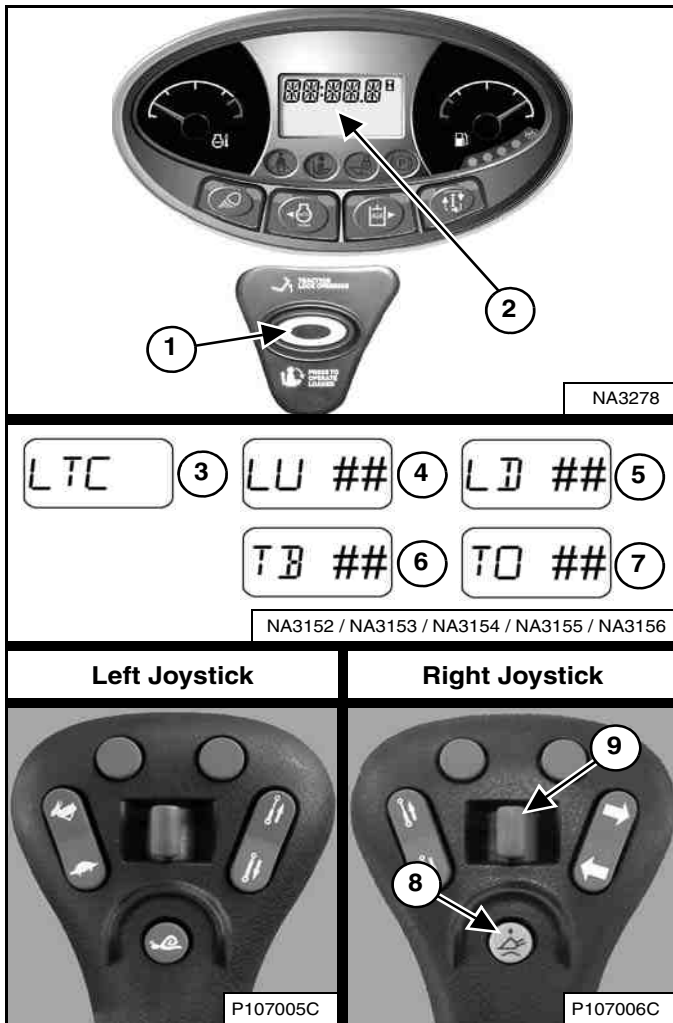

LTC – Lift and Tilt Compensation  
 LU – Lift Up  
 LD – Lift Down  
 TB – Tilt Back  
 TO – Tilt Out

1. Press and hold the float button (Item 8). Press the PRESS TO OPERATE LOADER button (Item 1). Release both buttons. This will open the lift and tilt compensation menu. [LTC] (Item 3) will appear in the data display (Item 2) [Figure 74].

2. Move the left joystick outward and hold. [LU ##] (Item 4) will appear in the data display. (## will indicate the current setting.) Move the switch (Item 9) [Figure 74] to the right repeatedly until a slight upward movement of the lift arms is noticed. The setting will increase by one each time the switch is moved. The available range of adjustment is -25 to 35.

**NOTE: If the lift arms begin to move immediately, move the switch (Item 9) [Figure 74] to the left repeatedly until lift arm movement stops, then move the switch to the right repeatedly until a slight upward movement of the lift arms is noticed. (This procedure also applies to the next three steps.)**

3. Move the left joystick inward and hold. [LD ##] (Item 5) will appear in the data display. Move the switch (Item 9) [Figure 74] to the right repeatedly until a slight downward movement of the lift arms is noticed.
4. Move the right joystick inward and hold. [TB ##] (Item 6) will appear in the data display. Move the switch (Item 9) [Figure 74] to the right repeatedly until a slight backward tilt movement of the Bob-Tach frame is noticed.
5. Move the right joystick outward and hold. [TO ##] (Item 7) will appear in the data display. Move the switch (Item 9) [Figure 74] to the right repeatedly until a slight forward tilt movement of the Bob-Tach frame is noticed.

#### Exiting The Lift And Tilt Compensation Menu:

The current lift and tilt compensation setting can be saved by pressing the PRESS TO OPERATE LOADER button (Item 1) [Figure 74]. The machine will exit from the lift and tilt compensation menu.

#### OR

Raise and lower the seat bar to exit from the lift and tilt compensation menu without saving. This will cancel all changes made. Press the PRESS TO OPERATE LOADER button (Item 1) [Figure 74] to continue machine operation.

Perform several lift and tilt functions to determine if the settings match your preferences. Repeat procedure if desired.

## HYDRAULIC CONTROLS

Put your feet on the footrests and **KEEP THEM THERE** any time you operate the loader.

### Selectable Joystick Controls (SJC) In 'ISO' Control Pattern

Figure 75

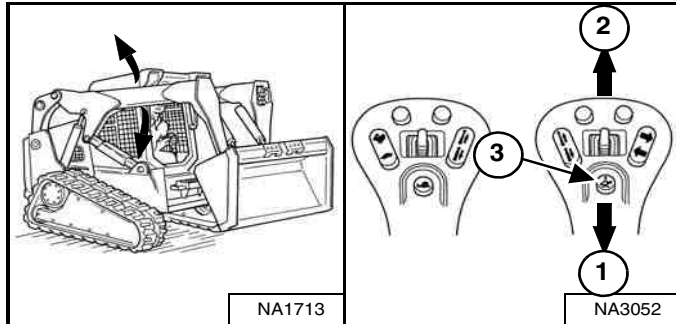

#### Lift Arm Operation – (Right Hand Joystick)

Move the joystick backward (Item 1) [Figure 75] to raise the lift arms.

Move the joystick forward (Item 2) [Figure 75] to lower the lift arms.

#### Lift Arm Float Position – (Right Hand Joystick)

Press and hold the Float button (Item 3) while the joystick is in NEUTRAL. Move the joystick to lift arm down position (Item 2) [Figure 75], then release the button.

Press Float button (Item 3) again or move the joystick to lift arm up position (Item 1) [Figure 75] to disengage.

Use the float position of the lift arms to level loose material while driving backward.

Figure 76

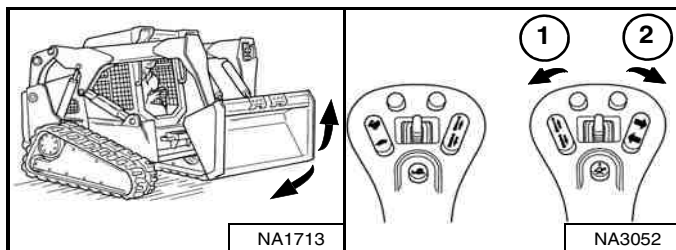

#### Tilt Operation – (Right Hand Joystick)

Move the joystick inward (Item 1) [Figure 76] to tilt the bucket backward.

Move the joystick outward (Item 2) [Figure 76] to tilt the bucket forward.

### Selectable Joystick Controls (SJC) In 'H' Control Pattern

Figure 77

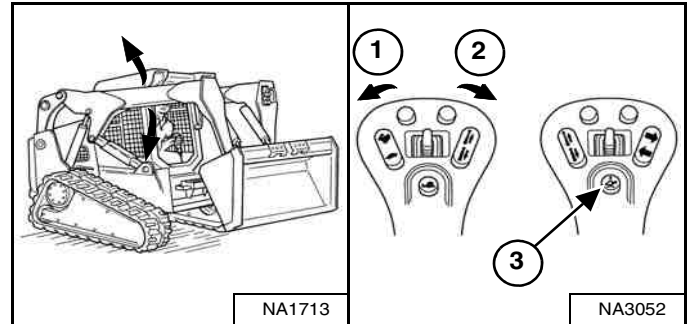

#### Lift Arm Operation – (Left Hand Joystick)

Move the joystick outward (Item 1) [Figure 77] to raise the lift arms.

Move the joystick inward (Item 2) [Figure 77] to lower the lift arms.

#### Lift Arm Float Position – (Left And Right Hand Joysticks)

Press and hold the Float button (Item 3) while the joysticks are in NEUTRAL. Move the left joystick to lift arm down position (Item 2) [Figure 77], then release the button.

Press Float button (Item 3) again or move the left joystick to lift arm up position (Item 1) [Figure 77] to disengage.

Use the float position of the lift arms to level loose material while driving backward.

Figure 78

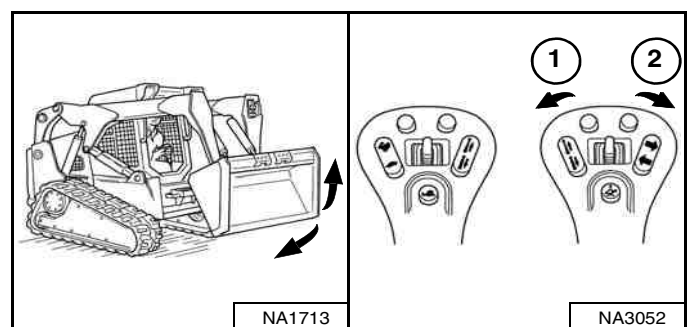

#### Tilt Operation – (Right Hand Joystick)

Move the joystick inward (Item 1) [Figure 78] to tilt the bucket backward.

Move the joystick outward (Item 2) [Figure 78] to tilt the bucket forward.



## HYDRAULIC CONTROLS (CONT'D)

### Hydraulic Bucket Positioning

The function of hydraulic bucket positioning is to keep the bucket at the same approximate angle as the lift arms are raised.

Figure 79

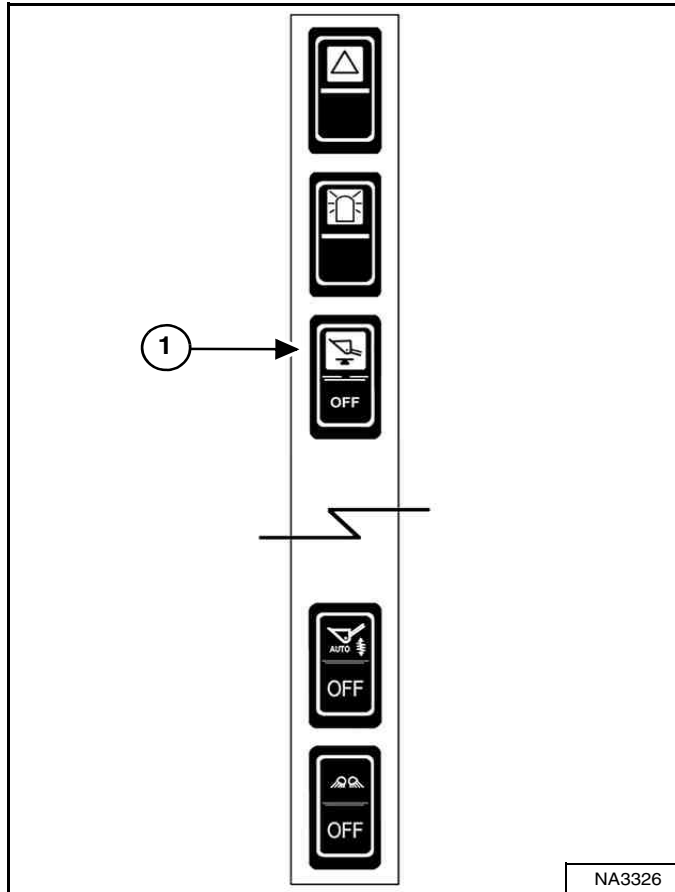

Press the top of the Bucket Positioning switch (Item 1) [Figure 79] on the left switch panel to engage the bucket positioning function. The amber light in the switch will turn ON.

Press the bottom of the switch to disengage. The amber light will turn OFF.

Bucket positioning functions only during upward lift cycle.

## HYDRAULIC CONTROLS (CONT'D)

### Automatic Ride Control

This machine may be equipped with Automatic Ride Control.

Automatic ride control provides a smoother ride, reduced load spillage, and improved machine control when traveling over uneven ground with heavy loads or in heavy digging applications.

Figure 80

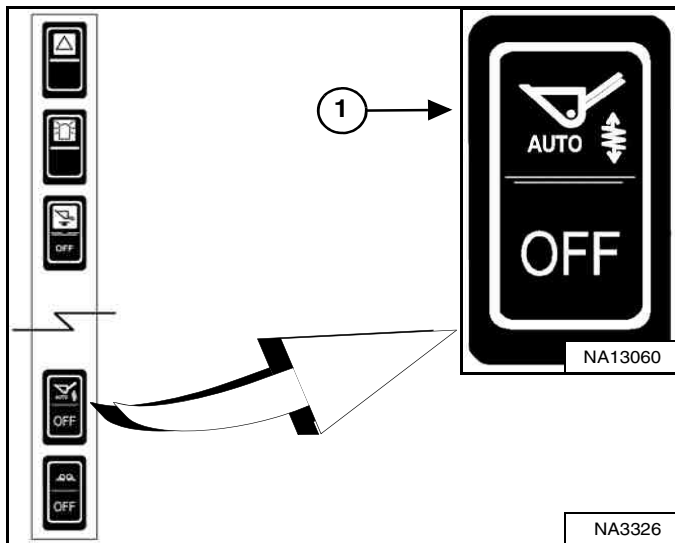

Press the top of the Automatic Ride Control switch (Item 1) [Figure 80] on the left switch panel to engage the automatic ride control function.

The loader software will engage and disengage ride control automatically based on lift arm load and operation.

The automatic ride control system uses an accumulator that requires occasional service. (See AUTOMATIC RIDE CONTROL ACCUMULATOR on Page 181.)

Press the bottom of the switch to disengage.

**NOTE:** Certain applications will not benefit from using automatic ride control. Turn OFF when using certain attachments for better performance.

## WARNING

**AVOID UNEXPECTED LIFT ARM MOVEMENT**  
Operating with the Automatic Ride Control switch in the AUTO position may result in the lift arms slowly raising during certain conditions when the operator moves the hydraulic controls in a specific manner:

1. A small or no load on the lift arms. **EXAMPLE:** Empty bucket or no attachment installed.

WITH

2. High hydraulic pressure in the tilt or auxiliary hydraulic system. **EXAMPLE:** Holding the tilt control forward or backward after it stops moving OR when an attachment hydraulic motor is stalled.

AND

3. While moving the lift control to raise or lower the lift arms.

**NOTE:** The slow upward movement of the lift arms will continue briefly even after the operator moves the hydraulic controls back to NEUTRAL under the conditions and operation described above.

Disengage the automatic ride control functions for applications where precise lift arm control is required or whenever unexpected lift arm movement is not desired.

W-3017-0816

## HYDRAULIC CONTROLS (CONT'D)

### Reversing Fan

This machine may be equipped with a Reversing Fan.

The function of the reversing fan is to clear dust and debris from the rear grille. This is accomplished by reversing the direction of the cooling fan for several seconds.

The operator can select automatic or manual operation of the reversing fan.

Figure 81

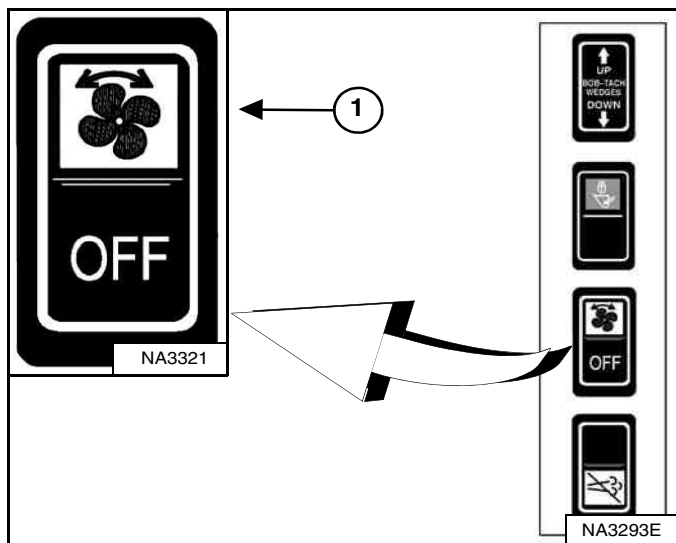

#### Automatic:

- Press the top of the Reversing Fan switch (Item 1) [Figure 81] on the right switch panel to put the switch into the middle position.
- The machine will reverse the fan automatically based on fluid temperature as long as automatic operation is selected.

#### Manual:

- Fully press the top of the Reversing Fan switch (Item 1) [Figure 81] on the right switch panel to perform one reversing cycle.
- The switch will return to automatic operation when released.

The top of the switch will light in the Automatic and Manual positions.

Press the bottom of the switch to disengage.

**NOTE:** To protect vital systems, the fan will not reverse when fluid temperatures approach overheating conditions. Cleaning or servicing the cooling system may be required to continue operation. (See Cleaning on Page 151.)

Figure 82



Reversing fan is disabled when the engine coolant or hydraulic fluid temperature is too high or too low.

Selecting manual operation of the reversing fan when disabled will cause the following indications:

1. The alarm will beep once.
2. Service code [RFOFF] will appear in the data display [Figure 82] for several seconds.

## HYDRAULIC CONTROLS (CONT'D)

### FRONT Auxiliary Hydraulics Operation

Figure 83



Press the Auxiliary Hydraulics button (Item 2) [Figure 83] once to activate the auxiliary hydraulics.

The light (Item 1) [Figure 83] is ON.

Figure 84

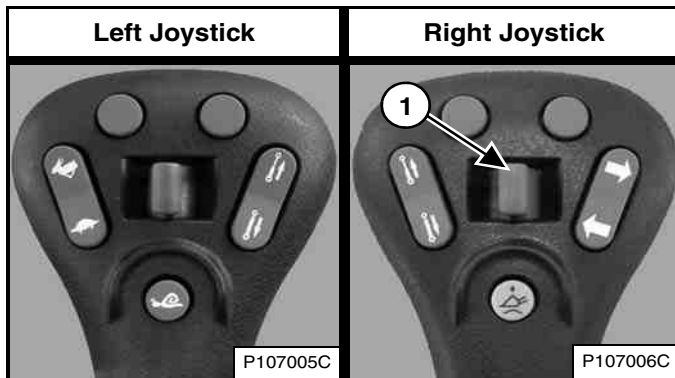

Move the Front Auxiliary Hydraulic switch (Item 1) [Figure 84] to the right or left to change direction of the auxiliary hydraulic fluid flow to the front quick couplers. If you move the switch halfway, the auxiliary functions move at approximately one-half speed. (EXAMPLE: Open and close grapple teeth.)

Release the Front Auxiliary Hydraulic switch to stop hydraulic fluid flow to the front quick couplers.

#### Loaders Without High-Flow Hydraulics

To deactivate the auxiliary hydraulics, press the Auxiliary Hydraulics button (Item 2) [Figure 83] again.

#### Loaders With High-Flow Hydraulics

To deactivate the auxiliary hydraulics, press the Auxiliary Hydraulics button (Item 2) [Figure 83] two times.

#### All Loaders

The light (Item 1) [Figure 83] is OFF.

**NOTE: When the operator is seated and raises the seat bar, the Auxiliary Hydraulic System (Front and Rear) will deactivate.**

## HYDRAULIC CONTROLS (CONT'D)

### FRONT Auxiliary Hydraulics Operation (CONTINUOUS FLOW)

Figure 85

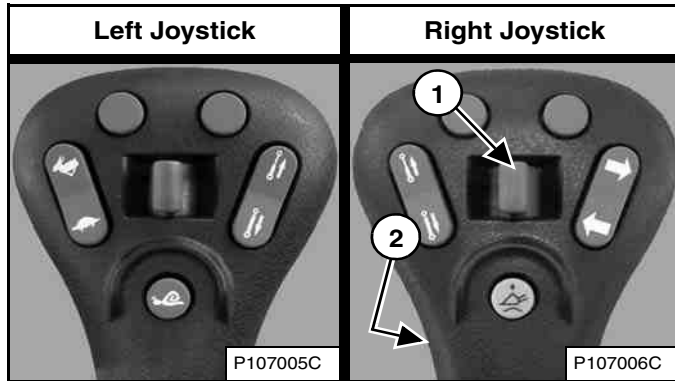

After activating the auxiliary hydraulics, press the Continuous Flow Control switch (Item 2) [Figure 85] to allow constant auxiliary hydraulic fluid flow to the front female coupler (female coupler is pressurised). (EXAMPLE: Operate a backhoe.)

To stop continuous auxiliary hydraulic fluid flow, press the Continuous Flow Control switch (Item 2) [Figure 85] a second time.

**NOTE:** When the operator is seated and raises the seat bar, the Auxiliary Hydraulic System (Front *and* Rear) will deactivate.

### FRONT Auxiliary Hydraulics Operation (REVERSE CONTINUOUS FLOW)

To allow constant auxiliary hydraulic fluid flow to the front male coupler (male coupler is pressurised):

1. Activate the auxiliary hydraulics.
2. Move the Front Auxiliary Hydraulic switch (Item 1) [Figure 85] to the left and hold.
3. Press the Continuous Flow Control switch (Item 2) [Figure 85].
4. Release the Front Auxiliary Hydraulic switch.

**NOTE:** Reverse flow can cause damage to some attachments. Use reverse flow with your attachment only if approved. See your attachment Operation & Maintenance Manual for detailed information.

To stop reverse continuous auxiliary hydraulic fluid flow, press the Continuous Flow Control switch (Item 2) [Figure 85] a second time.

**NOTE:** When the operator is seated and raises the seat bar, the Auxiliary Hydraulic System (Front *and* Rear) will deactivate.

## HYDRAULIC CONTROLS (CONT'D)

### REAR Auxiliary Hydraulics Operation

This machine may be equipped with rear auxiliary hydraulics.

**Figure 86**

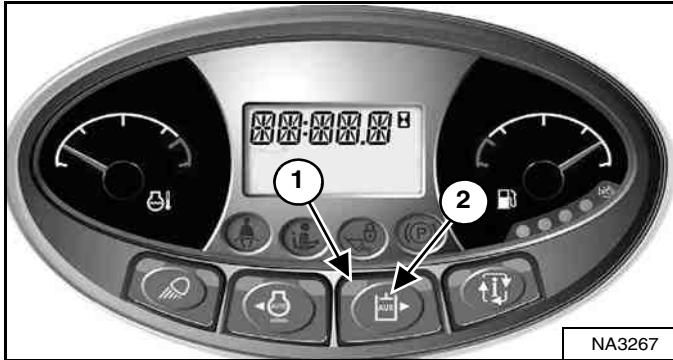

Press the Auxiliary Hydraulics button (Item 2) [Figure 86] once to activate the auxiliary hydraulics.

The light (Item 1) [Figure 86] is ON.

**Figure 87**

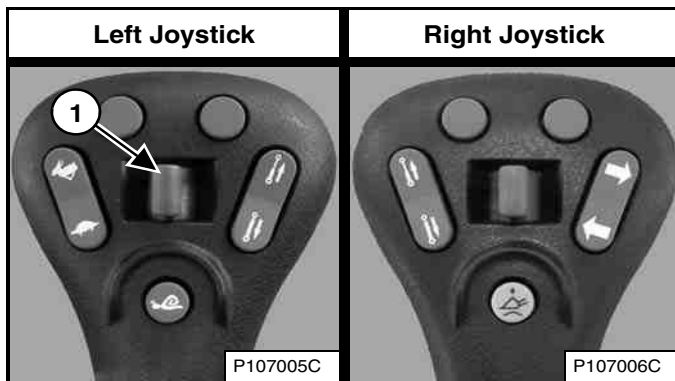

**Figure 88**



Move the Rear Auxiliary Hydraulic switch (Item 1) [Figure 87] to the right or left to change direction of the auxiliary hydraulic fluid flow to the rear quick couplers [Figure 88]. (EXAMPLE: Raise and lower rear stabilisers.) Release the switch to stop fluid flow.

#### *Loaders Without High-Flow Hydraulics*

To deactivate the auxiliary hydraulics, press the Auxiliary Hydraulics button (Item 2) [Figure 86] again.

#### *Loaders With High-Flow Hydraulics*

To deactivate the auxiliary hydraulics, press the Auxiliary Hydraulics button (Item 2) [Figure 86] two times.

#### *All Loaders*

The light (Item 1) [Figure 86] is OFF.

**NOTE:** When the operator is seated and raises the seat bar, the Auxiliary Hydraulic System (Front and Rear) will deactivate.

## HYDRAULIC CONTROLS (CONT'D)

### High-Flow Auxiliary Hydraulics Operation

This machine may be equipped with High-Flow Auxiliary Hydraulics.

The High-Flow function provides additional hydraulic fluid flow to the system to operate an attachment that requires more hydraulic flow. (EXAMPLE: High-Flow Planer)

**Figure 89**



Press the Auxiliary Hydraulics button (Item 2) once to activate the auxiliary hydraulics. The light (Item 1) [Figure 89] is ON.

Press the Auxiliary Hydraulics button (Item 2) a second time to activate high-flow auxiliary hydraulics. Both lights (Items 1 and 3) are ON. [HIFLO] (Item 4) [Figure 89] will appear briefly in the data display.

Press the Auxiliary Hydraulics button (Item 2) a third time to deactivate auxiliary hydraulics. Both lights (Items 1 and 3) [Figure 89] are OFF.

#### *Attachments That Automatically Enable High-Flow Hydraulics:*

Press button once to activate auxiliary hydraulics and high-flow, both lights are ON; second button press will deactivate high-flow hydraulics, right light is OFF; third button press will deactivate auxiliary hydraulics, both lights are OFF.

#### *Attachments That Automatically Disable High-Flow Hydraulics:*

Press button once to activate auxiliary hydraulics, left light is ON; second button press will not activate high-flow hydraulics, right light is ON briefly and turns OFF; third button press will deactivate auxiliary hydraulics, both lights are OFF.

**NOTE: See attachment Operation & Maintenance Manual for more information.**

## HYDRAULIC CONTROLS (CONT'D)

### Quick Couplers

# ! WARNING

#### AVOID INJURY OR DEATH

Diesel fuel or hydraulic fluid under pressure can penetrate skin or eyes, causing serious injury or death. Fluid leaks under pressure may not be visible. Use a piece of cardboard or wood to find leaks. Do not use your bare hand. Wear safety goggles. If fluid enters skin or eyes, get immediate medical attention from a doctor familiar with this injury.

W-2072-EN-0909

# ! WARNING

#### AVOID BURNS

Hydraulic fluid, tubes, fittings and quick couplers can get hot when running machine and attachments. Be careful when connecting and disconnecting quick couplers.

W-2220-0396

Figure 90

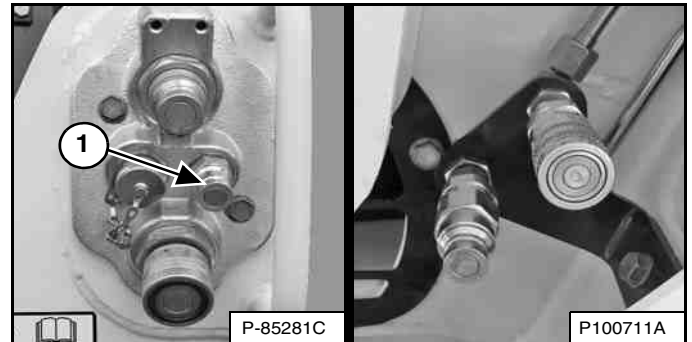

#### To Connect:

Remove dirt or debris from the surface of the male and female couplers, and from the outside diameter of the male couplers. Visually check the couplers for corroding, cracking, damage, or excessive wear. If any of these conditions exist, the coupler(s) [Figure 90] must be replaced.

Install the male couplers into the female couplers. Full connection is made when the ball release sleeves slide forward on the female couplers.

Some attachments have a case drain that needs to be connected to the small quick coupler (Item 1) [Figure 90].

#### To Disconnect:

Hold the male couplers. Retract the sleeves on the female couplers until couplers disconnect.



**HYDRAULIC CONTROLS (CONT'D)**

**Relieve Auxiliary Hydraulic Pressure (Loader And Attachment)**



**AVOID BURNS**

Hydraulic fluid, tubes, fittings and quick couplers can get hot when running machine and attachments. Be careful when connecting and disconnecting quick couplers.

W-2220-0396



**AVOID INJURY OR DEATH**

Diesel fuel or hydraulic fluid under pressure can penetrate skin or eyes, causing serious injury or death. Fluid leaks under pressure may not be visible. Use a piece of cardboard or wood to find leaks. Do not use your bare hand. Wear safety goggles. If fluid enters skin or eyes, get immediate medical attention from a doctor familiar with this injury.

W-2072-EN-0909

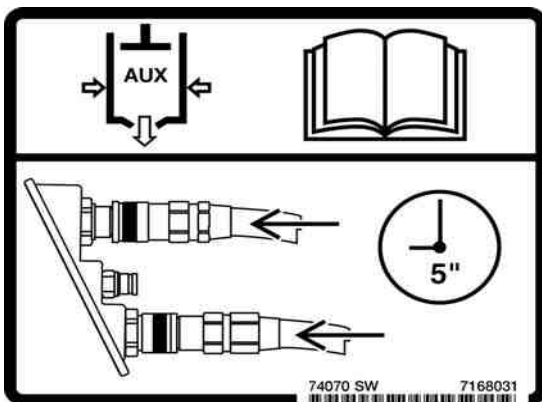

*Front Auxiliary Quick Couplers*

*When Connecting:* Push the quick couplers tightly together and hold for 5 seconds; the pressure is automatically relieved as the couplers are installed.

*When Disconnecting:* Push the quick couplers tightly together and hold for 5 seconds; then retract the sleeves until the couplers disconnect.

*Rear Auxiliary Quick Couplers*

Put the attachment flat on the ground. Stop the engine and turn the key switch to RUN.

**Figure 91**



Press the Auxiliary Hydraulics button (Item 1) [Figure 91].

**Figure 92**

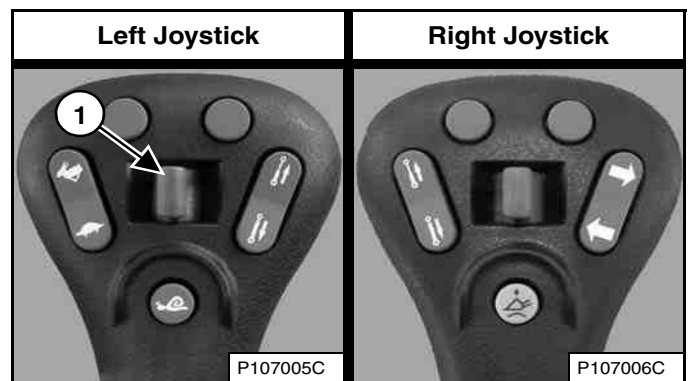

Move the Rear Auxiliary Hydraulic switch (Item 1) [Figure 92] to the left and right several times. Turn the key switch to STOP.

## ATTACHMENT CONTROL DEVICE (ACD)

This machine may be equipped with an Attachment Control Device.

### Description

Figure 93

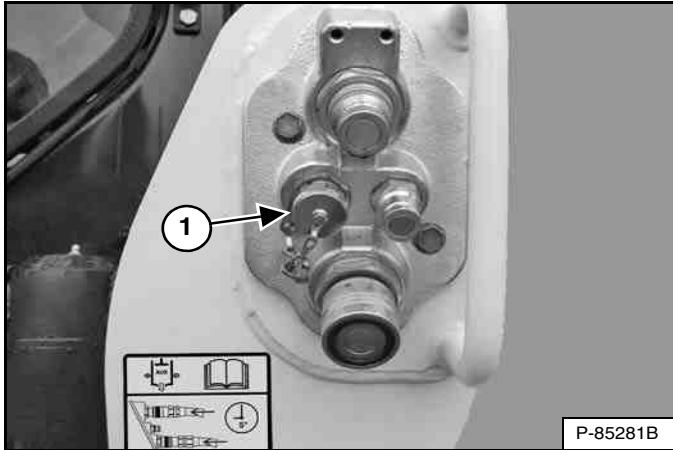

Connect the attachment electrical harness to the attachment control device (Item 1) [Figure 93].

Figure 94

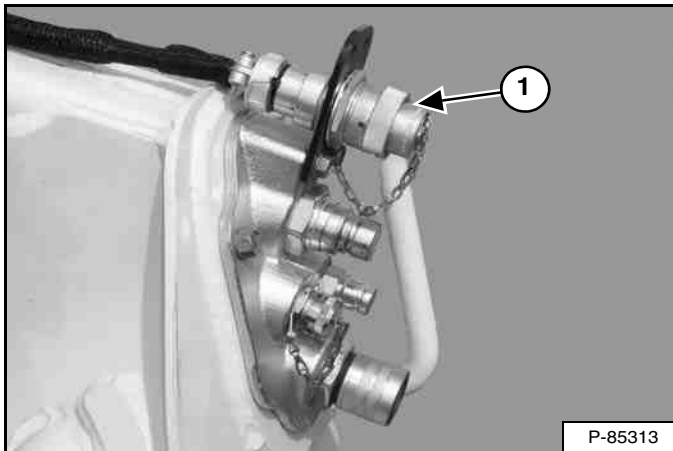

You will need the 14-Pin Attachment Control Device kit (Item 1) [Figure 94] to operate early model attachments. See your Bobcat loader dealer.

Figure 95

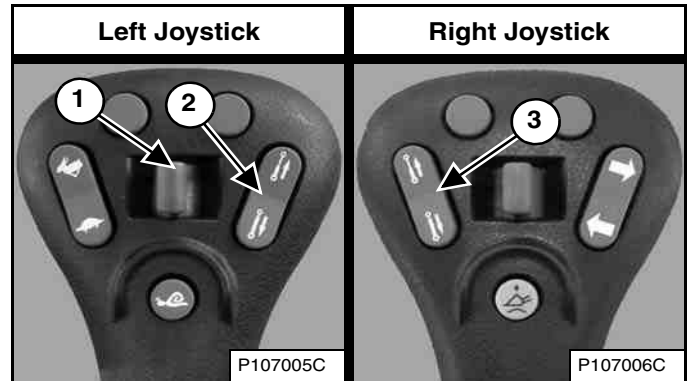

Additional switches (Items 1, 2, and 3) [Figure 95] are used to control some attachment functions through the attachment control device.

**NOTE:** ACD takes over the function of the Rear Auxiliary Hydraulic switch (Item 1) [Figure 95] from rear auxiliary hydraulics when an attachment electrical harness is attached to the ACD.

See the appropriate attachment Operation & Maintenance Manual for control details.

## DAILY INSPECTION

### Daily Inspection And Maintenance

Maintenance work must be done at regular intervals. Failure to do so will result in excessive wear and early failures. The Service Checklist And Schedule is a guide for correct maintenance of the Bobcat loader.

Figure 96

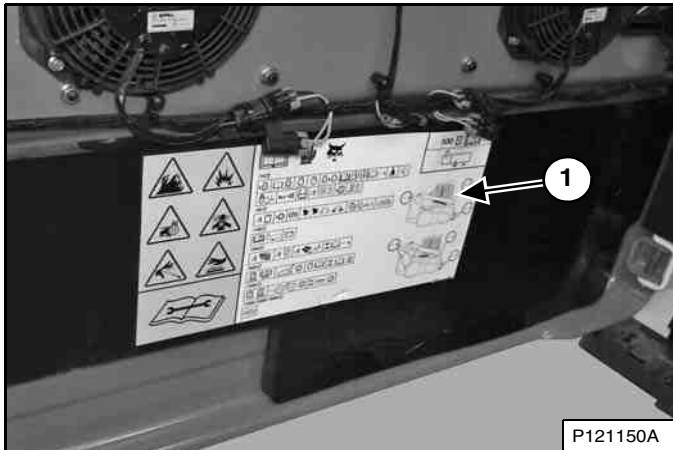

The Service Checklist And Schedule (Item 1) [Figure 96] is located inside the rear door of the loader.

A complete list of scheduled maintenance tasks is also located in the Preventive Maintenance section of this manual. (See SERVICE SCHEDULE on Page 123.)

## WARNING

### AVOID INJURY OR DEATH

- Keep door / cover closed except for service.
- Keep engine clean of flammable material.
- Keep body, loose objects and clothing away from electrical contacts, moving parts, hot parts and exhaust.
- Do not use the machine in space with explosive dusts or gases or with flammable material near exhaust.
- Never use ether or starting fluid on diesel engine with glow plugs or air intake heater. Use only starting aids as approved by engine manufacturer.
- Leaking fluids under pressure can enter skin and cause serious injury.
- Battery acid causes severe burns; wear goggles. If acid contacts eyes, skin, or clothing, flush with water. For contact with eyes, flush and get medical attention.
- Battery makes flammable and explosive gas. Keep arcs, sparks, flames and lighted tobacco away.
- For jump start, connect negative cable to the machine engine last (never at the battery). After jump start, remove negative connection at the engine first.
- Exhaust gases can kill. Always ventilate.

W-2782-0409

**NOTE:** Fluids such as engine oil, hydraulic fluid, and coolant must be disposed of in an environmentally safe manner. Some regulations require that certain spills and leaks on the ground must be cleaned in a specific manner. See local regulations for correct disposal.

## WARNING

Operator must have instructions before operating the machine. Untrained operators can cause injury or death.

W-2001-0502



## DAILY INSPECTION (CONT'D)

### Daily Inspection And Maintenance (Cont'd)

The following list of items must be checked daily:

- Engine Oil Level
- Hydraulic Fluid Level
- Engine Air Cleaner – Check System for Damage or Leaks
- Engine Cooling System – Check System for Damage or Leaks, Check Coolant Level, Clean Hydraulic Fluid Cooler and Radiator Assembly, Fuel Cooler, Rear Grille, and Screens on Rear Door and Engine Cover
- Operator Cab and Cab Mounting Hardware
- Seat Belt
- Seat Bar and Control Interlocks
- Bobcat Interlock Control System (BICS™)
- Front Horn – Check for Proper Function
- Grease Pivot Pins (Lift Arms, Lift Links, Bob-Tach, Cylinders, Bob-Tach Wedges)
- Tracks – Check for Wear or Damage
- Loose or Broken Parts – Repair or Replace as Necessary
- Safety Treads and Safety Signs (Decals) – Replace as Necessary
- Lift Arm Support Device – Replace if Damaged

## IMPORTANT

This machine is factory equipped with a spark arrester exhaust system that must be maintained for proper function.

- **WITH MUFFLER**  
The muffler chamber must be emptied every 100 hours of operation to keep it in working condition.
- **WITH SELECTIVE CATALYST REDUCTION (SCR) AND / OR DIESEL OXIDATION CATALYST (DOC)**  
Do not remove or modify the DOC or SCR.

The SCR must be maintained according to the instructions in the Operation & Maintenance Manual for proper function.

- **WITH DIESEL PARTICULATE FILTER (DPF)**  
The DPF must be maintained according to the instructions in the Operation & Maintenance Manual for proper function.

(If this machine is operated on flammable forest, brush or grass cover land, a spark arrester attached to the exhaust system may be required and must be maintained in working order. Refer to local laws and regulations for spark arrester requirements.)

I-2350-EN-1114

## IMPORTANT

### PRESSURE WASHING DECALS

- Never direct the stream at a low angle toward the decal that could damage the decal causing it to peel from the surface.
- Direct the stream at a 90 degree angle and at least 300 mm (12 in) from the decal. Wash from the centre of the decal toward the edges.

I-2226-EN-0910

**PRE-STARTING PROCEDURE**

**Entering The Loader**

**Figure 97**



Use the bucket or attachment steps, grab handles, and safety treads (on the loader lift arms and frame) to get on and off the loader, maintaining a three-point contact at all times **[Figure 97]**. Do not jump.

Safety treads are installed on the Bobcat loader to provide a slip resistant surface for getting on and off the loader.

Keep safety treads clean and replace when damaged. Replacement treads are available from your Bobcat dealer.

**Operation & Maintenance Manual And Operator's Handbook Locations**

**Figure 98**

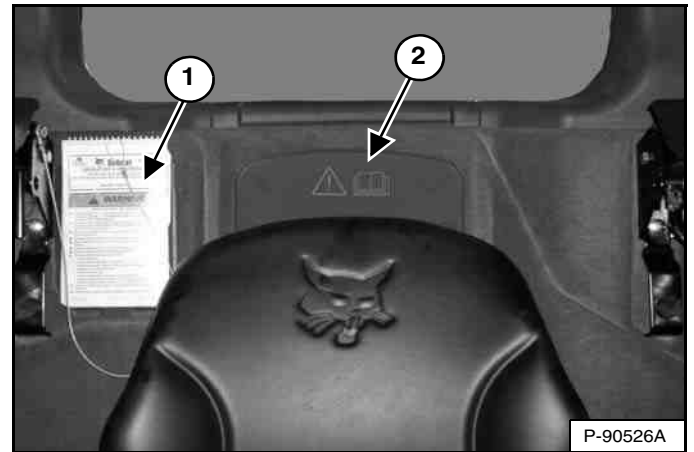

Read and understand the Operation & Maintenance Manual and the Operator's Handbook (Item 1) **[Figure 98]** before operating the loader.

The Operation & Maintenance Manual and other manuals can be kept in a container (Item 2) **[Figure 98]** provided behind the operator seat.



**AVOID INJURY OR DEATH**

Instructions are necessary before operating or servicing machine. Read and understand the Operation & Maintenance Manual, Operator's Handbook and signs (decals) on machine. Follow warnings and instructions in the manuals when making repairs, adjustments or servicing. Check for correct function after adjustments, repairs or service. Untrained operators and failure to follow instructions can cause injury or death.

W-2003-0807

## PRE-STARTING PROCEDURE (CONT'D)

### Seat Adjustment

#### *Suspension Seat (Standard)*

**Figure 99**

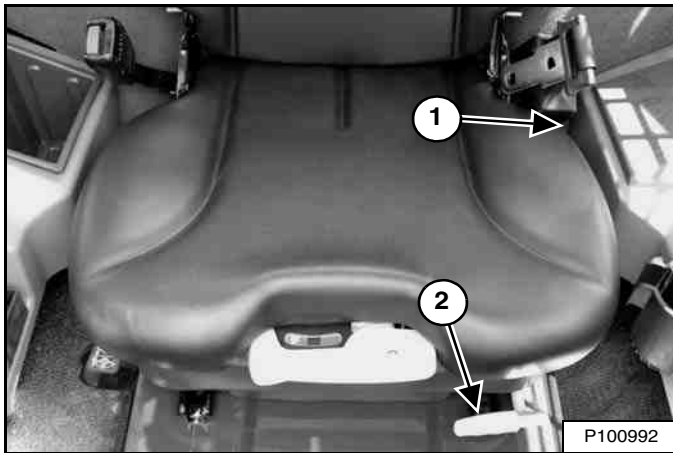

Pull the lever (Item 1) [Figure 99] up to adjust the angle of the seat back.

Pull the lever (Item 2) [Figure 99] up to adjust the seat position for comfortable operation of the loader controls.

**Figure 100**

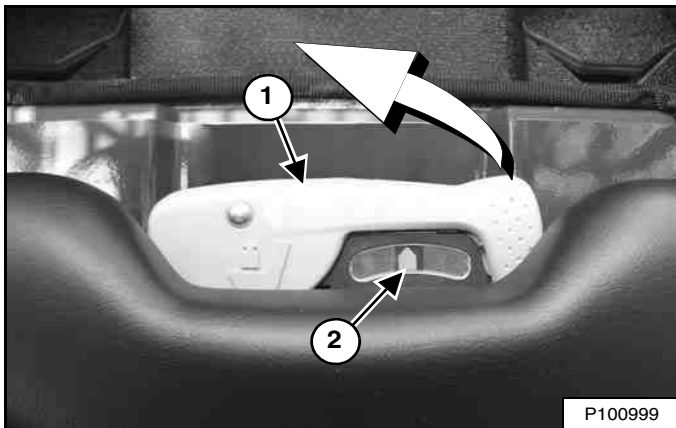

The lever (Item 1) is used to adjust the suspension response of the seat depending on the operator's weight. The optimum setting is achieved with the needle (Item 2) [Figure 100] centred in the gauge with the operator normally seated.

Pivot the lever out fully to adjust the setting. Pump lever between middle and upper positions to move the needle to the right. Pump lever between middle and lower positions to move the needle to the left. Return lever to the middle position and pivot lever back fully to lock in setting.

#### *Air Ride Suspension Seat (Option)*

**Figure 101**

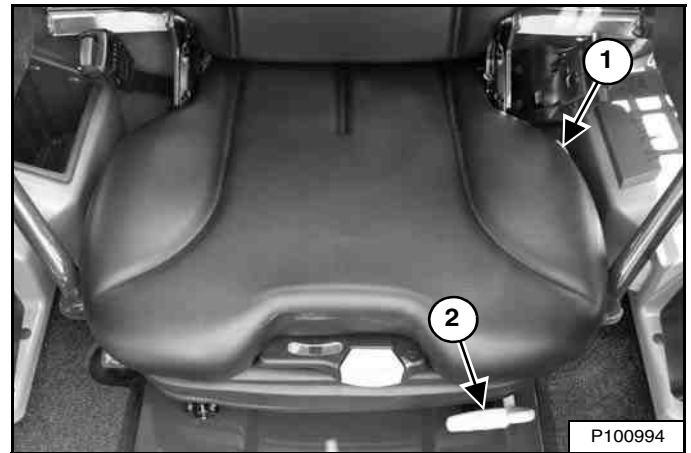

Pull the lever (Item 1) [Figure 101] up to adjust the angle of the seat back.

Pull the lever (Item 2) [Figure 101] up to adjust the seat position for comfortable operation of the loader controls.

**Figure 102**

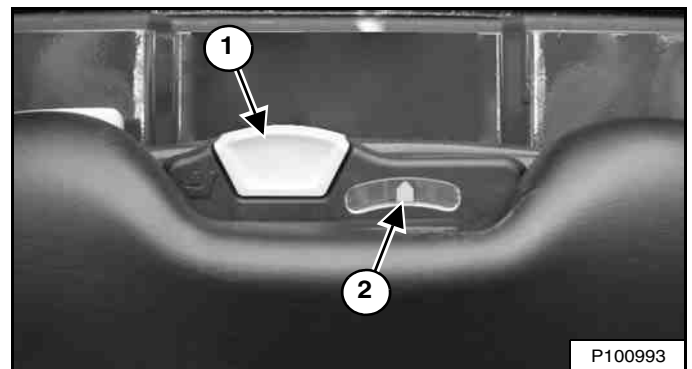

The lever (Item 1) is used to adjust the suspension response of the seat depending on the operator's weight. The optimum setting is achieved with the needle (Item 2) [Figure 102] centred in the gauge with the operator normally seated.

Pull the lever (Item 1) [Figure 102] up and hold to increase the amount of air in the seat suspension. Push the lever down and hold to decrease the amount of air in the seat suspension.

**NOTE: The loader electrical system must be turned ON to increase the amount of air in the seat suspension.**

**PRE-STARTING PROCEDURE (CONT'D)**

**Seat Belt Adjustment**

**Figure 103**

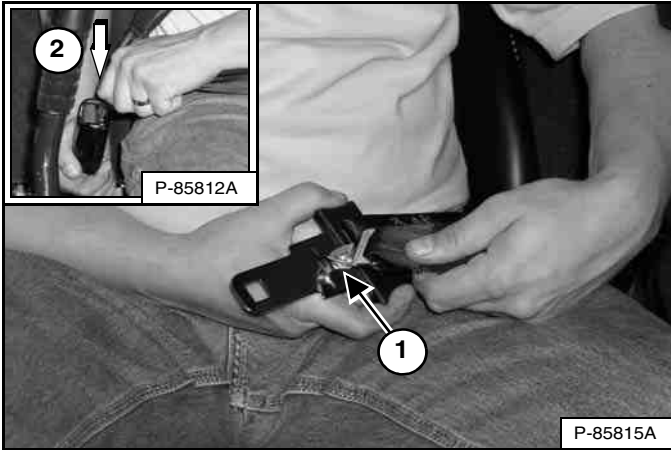

Connect the shoulder belt to the lap belt (Item 1). Pull the lap belt across to the right side of the seat and fasten (Item 2) [Figure 103].

The shoulder belt must be positioned over your left shoulder and lap belt over your lower hips.

**IMPORTANT**

Check the seat belt and shoulder belt retractors for correct operation.

Keep retractors clean and replace as necessary.

I-2199-0200

**Seat Bar**

**Figure 104**



Lower the seat bar and engage the parking brake [Figure 104].

Put the joysticks in NEUTRAL position.

**NOTE: Keep your hands on the joysticks and your feet on the footrests while operating the loader.**

**! WARNING**

**AVOID INJURY OR DEATH**

When operating the machine:

- Keep the seat belt fastened snugly.
- The seat bar must be lowered.
- Keep your feet on the foot rests and hands on control levers.

W-2399-0501

PRE-STARTING PROCEDURE (CONT'D)

Joystick Position Adjustment

Figure 105

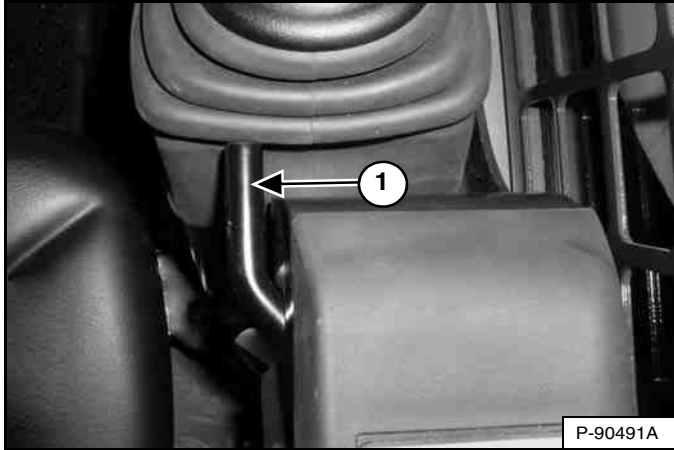

Pull the joystick adjustment lever (Item 1) [Figure 105] up to slide the loader joystick forward or backward to adjust for comfortable operation. (Right side shown.)



## STARTING THE ENGINE

### Standard Key Panel

# ! WARNING

### AVOID SERIOUS INJURY OR DEATH

- Engines can have hot parts and hot exhaust gas. Keep flammable material away.
- Do not use machines in atmosphere containing explosive dust or gases.

W-2051-0212

Perform the PRE-STARTING PROCEDURE. (See PRE-STARTING PROCEDURE on Page 91.)

Figure 106



Set the engine speed control to the low idle position [Figure 106].

Figure 107

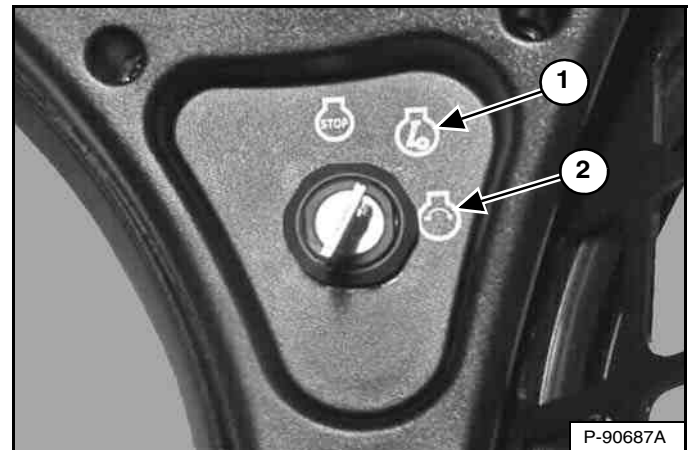

Turn the key switch to RUN (Item 1) [Figure 107]. The indicator lights on the left instrument panel will come ON briefly and the instrument panel / monitoring system will perform a self test.

Figure 108

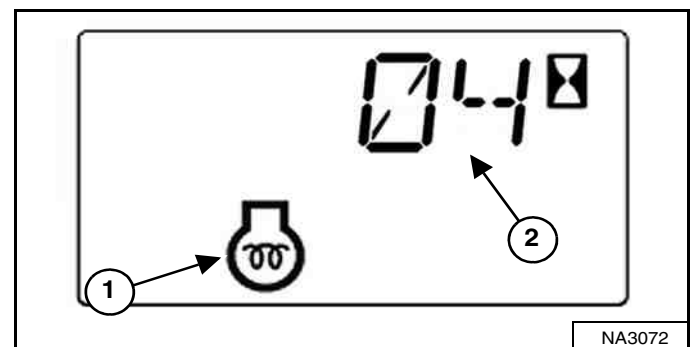

The machine will cycle the air intake heater automatically based on temperature. The engine preheat icon (Item 1) and the cycle time remaining (Item 2) [Figure 108] are displayed in the data display.

**NOTE:** It is recommended in cold weather to cycle the air intake heater twice before attempting to start the engine. This will allow for additional heating time for cold weather starting.

When the engine preheat icon goes OFF, turn the key switch to START (Item 2). Release the switch when the engine starts and allow the switch to return to the RUN position (Item 1) [Figure 107].

**STARTING THE ENGINE (CONT'D)**

**Standard Key Panel (Cont'd)**

**NOTE:** Make sure both joysticks are in the **NEUTRAL** position before starting the engine. Do not move the joysticks from the **NEUTRAL** position when turning the key switch to **RUN** or **START** with the BICS™ activated.

**! WARNING**

**AVOID INJURY OR DEATH**

- Fasten seat belt, start and operate only from the operator's seat.
- Never wear loose clothing when working near machine.

W-2135-1108

Figure 109

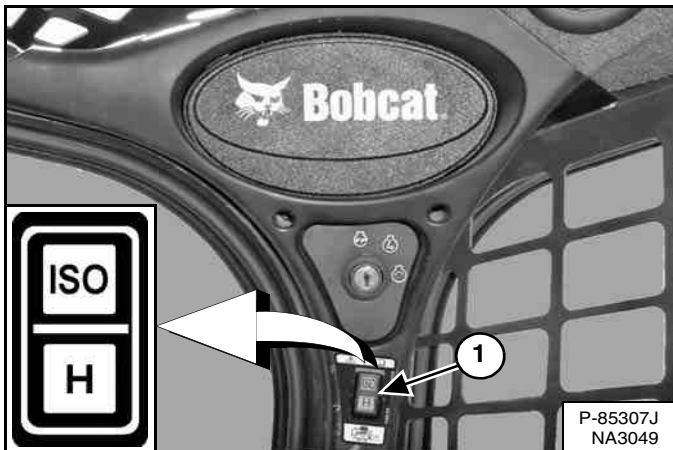

Select 'ISO' or 'H' Control Pattern (Item 1) [Figure 109].

Figure 110

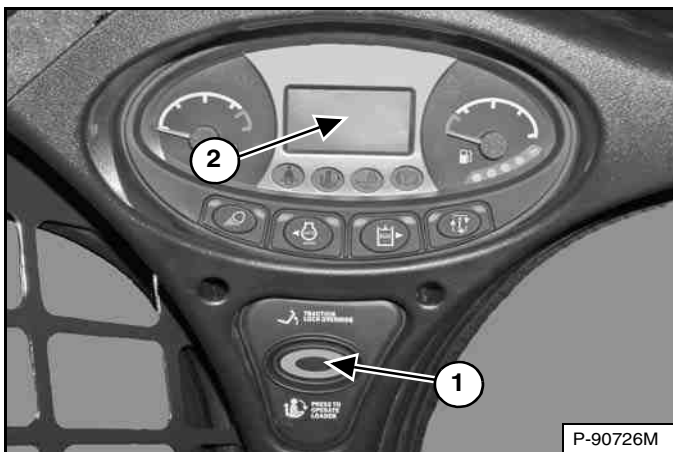

Press the **PRESS TO OPERATE LOADER** button (Item 1) [Figure 110] to activate the BICS™ and to perform hydraulic and loader functions.

The current drive response setting is displayed briefly in the data display (Item 2) each time the **PRESS TO OPERATE LOADER** button (Item 1) [Figure 110] is pressed.

**NOTE:** The light of the current switch position (ISO or H) will flash, which indicates **PRESS TO OPERATE LOADER** is required. The light will flash when the key switch is in the **RUN** position and continue to flash until the **PRESS TO OPERATE LOADER** button is pressed, then the light will become solid. If the mode (ISO / H) is changed while driving, the active mode light will remain solid and the pending mode light will flash. When operation of the machine is returned to **NEUTRAL**, the active mode light will turn off and the pending mode light will continue to flash until the **PRESS TO OPERATE LOADER** button is pressed.

**! WARNING**

**AVOID INJURY OR DEATH**

When an engine is running in an enclosed area, fresh air must be added to avoid concentration of exhaust fumes. If the engine is stationary, vent the exhaust outside. Exhaust fumes contain odorless, invisible gases which can kill without warning.

W-2050-0807

STARTING THE ENGINE (CONT'D)

Keyless Start Panel



**AVOID SERIOUS INJURY OR DEATH**

- Engines can have hot parts and hot exhaust gas. Keep flammable material away.
- Do not use machines in atmosphere containing explosive dust or gases.

W-2051-0212

Perform the PRE-STARTING PROCEDURE. (See PRE-STARTING PROCEDURE on Page 91.)

Figure 111



Set the engine speed control to the low idle position [Figure 111].

**NOTE:** Loaders with a Keyless Start Panel have a permanent, randomly generated Master Password set at the factory. Your loader will also have an Owner Password. The owner password can be changed to prevent unauthorised use of your loader. (See Changing The Owner Password on Page 208.) Keep your password in a safe location for future needs.

**NOTE:** The Password Lockout feature can be used to allow starting of the loader without a password. (See Password Lockout Feature on Page 208.)

Figure 112

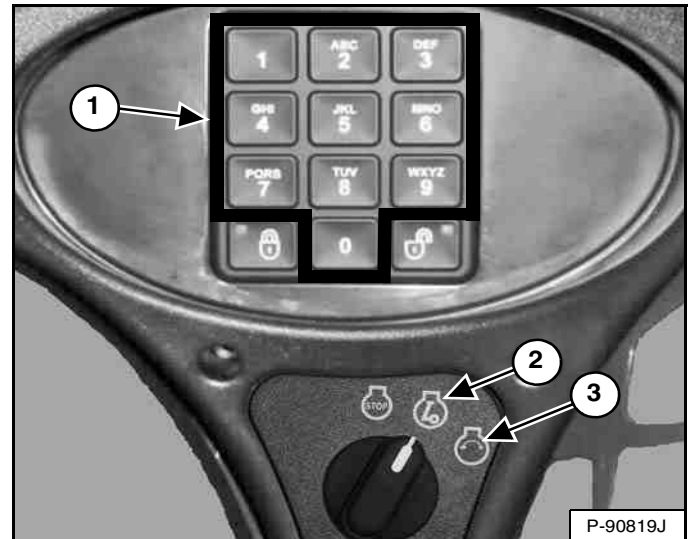

Turn the key switch to RUN (Item 2). The indicator lights on the left instrument panel will come ON briefly and the instrument panel / monitoring system will perform a self test. Use the numeric keypad (Item 1) [Figure 112] to enter the password.

Figure 113

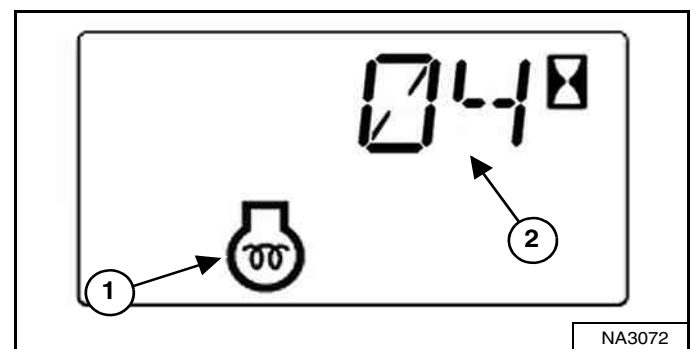

The machine will cycle the air intake heater automatically based on temperature. The engine preheat icon (Item 1) and the cycle time remaining (Item 2) [Figure 113] are displayed in the data display.

**NOTE:** It is recommended in cold weather to cycle the air intake heater twice before attempting to start the engine. This will allow for additional heating time for cold weather starting.

When the engine preheat icon goes OFF, turn the key switch to START (Item 3). Release the switch when the engine starts and allow the switch to return to the RUN position (Item 2) [Figure 112].

**STARTING THE ENGINE (CONT'D)**

**Keyless Start Panel (Cont'd)**

**NOTE:** Make sure both joysticks are in the **NEUTRAL** position before starting the engine. Do not move the joysticks from the **NEUTRAL** position when turning the key switch to **RUN** or **START** with the BICS™ activated.

**! WARNING**

**AVOID INJURY OR DEATH**

- Fasten seat belt, start and operate only from the operator's seat.
- Never wear loose clothing when working near machine.

W-2135-1108

Figure 114

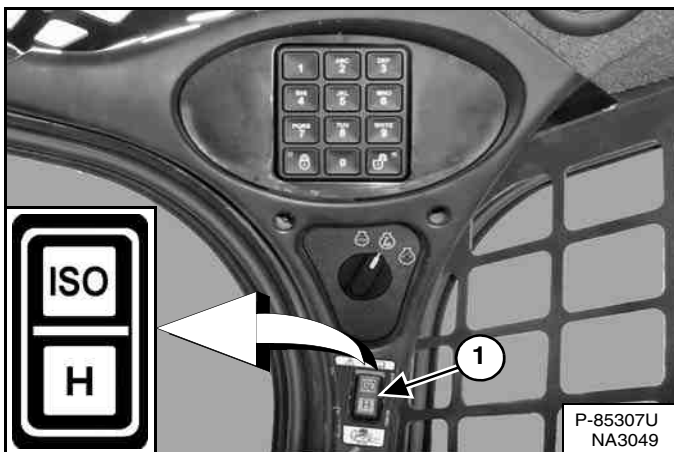

Select 'ISO' or 'H' Control Pattern (Item 1) [Figure 114].

Figure 115

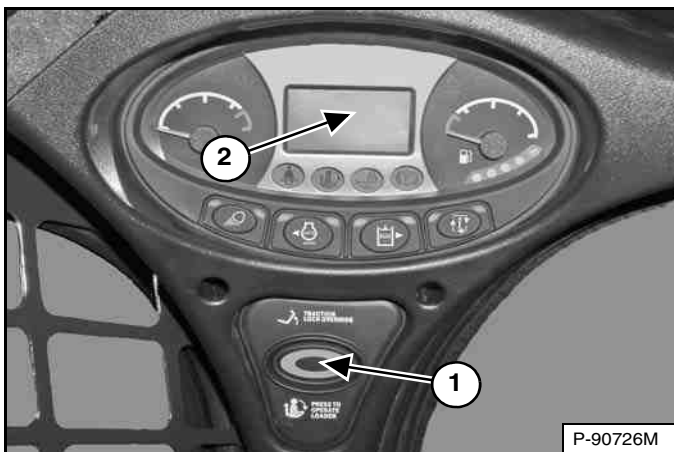

Press the **PRESS TO OPERATE LOADER** button (Item 1) [Figure 115] to activate the BICS™ and to perform hydraulic and loader functions.

The current drive response setting is displayed briefly in the data display (Item 2) each time the **PRESS TO OPERATE LOADER** button (Item 1) [Figure 115] is pressed.

**NOTE:** The light of the current switch position (**ISO** or **H**) will flash, which indicates **PRESS TO OPERATE LOADER** is required. The light will flash when the key switch is in the **RUN** position and continue to flash until the **PRESS TO OPERATE LOADER** button is pressed, then the light will become solid. If the mode (**ISO / H**) is changed while driving, the active mode light will remain solid and the pending mode light will flash. When operation of the machine is returned to **NEUTRAL**, the active mode light will turn off and the pending mode light will continue to flash until the **PRESS TO OPERATE LOADER** button is pressed.

**! WARNING**

**AVOID INJURY OR DEATH**

When an engine is running in an enclosed area, fresh air must be added to avoid concentration of exhaust fumes. If the engine is stationary, vent the exhaust outside. Exhaust fumes contain odorless, invisible gases which can kill without warning.

W-2050-0807

STARTING THE ENGINE (CONT'D)

Deluxe Instrumentation Panel



**AVOID SERIOUS INJURY OR DEATH**

- Engines can have hot parts and hot exhaust gas. Keep flammable material away.
- Do not use machines in atmosphere containing explosive dust or gases.

W-2051-0212

Perform the PRE-STARTING PROCEDURE. (See PRE-STARTING PROCEDURE on Page 91.)

Figure 116



Set the engine speed control to the low idle position [Figure 116].

**NOTE:** Loaders with a Deluxe Instrumentation Panel have a permanent, randomly generated Master Password set at the factory. Your loader will also be assigned an Owner Password. Your dealer will provide you with this password. Change the owner password to one that you will easily remember to prevent unauthorised use of your loader. (See Changing The Owner Password on Page 209.) Keep your password in a safe location for future needs.

**NOTE:** The Password Lockout feature can be used to allow starting of the loader without a password. (See Password Lockout Feature on Page 210.)

Figure 117

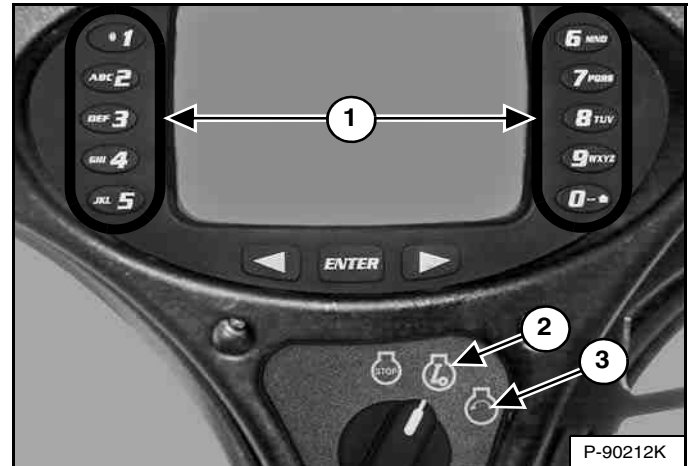

Turn the key switch to RUN (Item 2). The indicator lights on the left instrument panel will come ON briefly and the instrument panel / monitoring system will perform a self test. Use the numeric keypad (Item 1) [Figure 117] to enter the password.

Figure 118

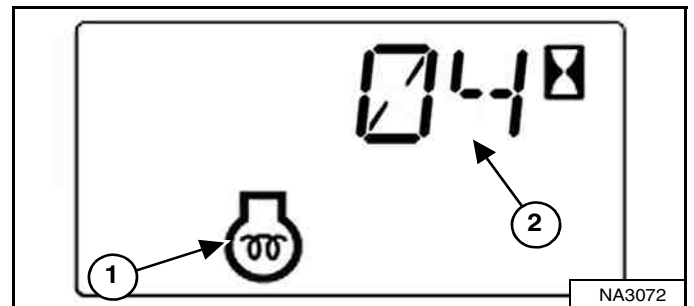

The machine will cycle the air intake heater automatically based on temperature. The engine preheat icon (Item 1) and the cycle time remaining (Item 2) [Figure 118] are displayed in the data display.

**NOTE:** The Deluxe Instrumentation Panel display screen will also display an engine preheat icon and [WAIT TO START].

**NOTE:** It is recommended in cold weather to cycle the air intake heater twice before attempting to start the engine. This will allow for additional heating time for cold weather starting.

When the engine preheat icon goes OFF, turn the key switch to START (Item 3). Release the switch when the engine starts and allow the switch to return to the RUN position (Item 2) [Figure 117].

**STARTING THE ENGINE (CONT'D)**

**Deluxe Instrumentation Panel (Cont'd)**

**NOTE:** Make sure both joysticks are in the **NEUTRAL** position before starting the engine. Do not move the joysticks from the **NEUTRAL** position when turning the key switch to **RUN** or **START** with the BICS™ activated.

**! WARNING**

**AVOID INJURY OR DEATH**

- Fasten seat belt, start and operate only from the operator's seat.
- Never wear loose clothing when working near machine.

W-2135-1108

Figure 119

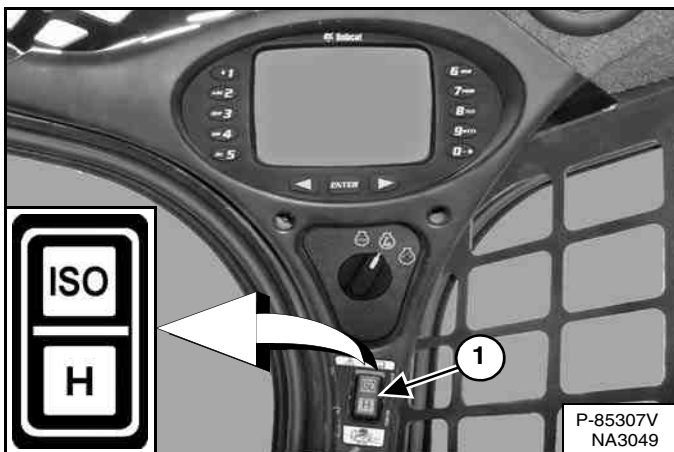

Select 'ISO' or 'H' Control Pattern (Item 1) [Figure 119].

Figure 120



Press the **PRESS TO OPERATE LOADER** button (Item 1) [Figure 120] to activate the BICS™ and to perform hydraulic and loader functions.

The current drive response setting is displayed briefly in the data display (Item 2) each time the **PRESS TO OPERATE LOADER** button (Item 1) [Figure 120] is pressed.

**NOTE:** The light of the current switch position (**ISO** or **H**) will flash, which indicates **PRESS TO OPERATE LOADER** is required. The light will flash when the key switch is in the **RUN** position and continue to flash until the **PRESS TO OPERATE LOADER** button is pressed, then the light will become solid. If the mode (**ISO / H**) is changed while driving, the active mode light will remain solid and the pending mode light will flash. When operation of the machine is returned to **NEUTRAL**, the active mode light will turn off and the pending mode light will continue to flash until the **PRESS TO OPERATE LOADER** button is pressed.

**! WARNING**

**AVOID INJURY OR DEATH**

When an engine is running in an enclosed area, fresh air must be added to avoid concentration of exhaust fumes. If the engine is stationary, vent the exhaust outside. Exhaust fumes contain odorless, invisible gases which can kill without warning.

W-2050-0807

## STARTING THE ENGINE (CONT'D)

### Warming The Hydraulic / Hydrostatic System

Let the engine operate for a minimum of 5 minutes to warm the engine and hydrostatic transmission fluid before operating the loader.

**NOTE:** The full range of the engine speed control will not be available until the engine controller determines the engine is adequately warmed.

## IMPORTANT

When the temperature is below  $-30^{\circ}\text{C}$  ( $-20^{\circ}\text{F}$ ), hydrostatic oil must be warmed before starting. The hydrostatic system will not get enough oil at low temperatures and will be damaged. Park the machine in an area where the temperature will be above  $-18^{\circ}\text{C}$  ( $0^{\circ}\text{F}$ ) if possible.

I-2007-0910

### Cold Temperature Starting

## ! WARNING

**EXPLOSION CAN CAUSE SERIOUS INJURY, DEATH OR SEVERE ENGINE DAMAGE**  
DO NOT use ether or starting fluid with glow plug or air intake heater systems.

W-2071-0415

If the temperature is below freezing, perform the following to make starting the engine easier:

- Replace the engine oil with the correct type and viscosity for the anticipated starting temperature. (See Engine Oil Chart on Page 148.)
- Make sure the battery is fully charged.
- Install an engine heater, available from your Bobcat loader dealer.

**NOTE:** The display screen of the Deluxe Instrumentation Panel may not be at full intensity when the temperature is below  $-26^{\circ}\text{C}$  ( $-15^{\circ}\text{F}$ ). The display screen may take 30 seconds to several minutes to warm up. All systems remain monitored even when the display screen is off.

### Cold Temperature Engine Speed Control

Figure 121



The engine controller will not allow full engine speed and torque when the engine temperature is too low. The following indications and actions are performed automatically by the engine controller:

1. Service code [COLD] will appear in the data display [Figure 121].
2. The engine controller will override the operator engine speed control setting and maintain optimum engine warm-up speed.  
  
Moving the operator engine speed control will cause the alarm to beep three times. The engine speed will remain overridden.
3. The alarm will beep two times and the data display will change to the hourmeter when the engine controller is no longer overriding engine speed. Engine speed control is returned to the operator.

**NOTE:** Engine speed will remain at low idle until the operator moves the engine speed control regardless of the engine speed control position.

**Full engine speed and torque may not be available until the engine controller determines the engine is adequately warmed.**

## MONITORING THE DISPLAY PANELS

### Left Panel

Figure 122



Frequently monitor the temperature and fuel gauges and BICS™ lights (all BICS™ lights must be OFF to operate loader) [Figure 122].

After the engine is running, frequently monitor the left instrument panel [Figure 122] for machine condition.

The associated icon is displayed if there is an error condition.

**EXAMPLE:** Engine Coolant Temperature is High.

The Engine Coolant Temperature icon (Item 1) [Figure 122] is ON.

Press the Information button (Item 2) [Figure 122] to cycle the data display until the service code screen is displayed. One of the following SERVICE CODES is displayed.

- [M0810] Engine Coolant Temperature Too High
- [M0811] Engine Coolant Temperature Extremely High

Find the cause of the service code and correct before operating the loader again. (See Service Codes List on Page 191.)

**NOTE:** The optional Deluxe Instrumentation Panel offers an additional view of service codes that includes a brief description. (See Viewing Service Codes on Page 190.)

### Warning And Shutdown

When a WARNING condition exists; the associated icon light is ON and the alarm sounds 3 beeps. If this condition is allowed to continue, there may be damage to the engine or loader hydraulic systems.

When a SHUTDOWN condition exists; the associated icon light is ON and the alarm sounds continuously. The monitoring system will automatically stop the engine in 15 seconds. The engine can be restarted to move or relocate the loader.

The SHUTDOWN feature is associated with the following icons:

- General Warning
- Engine Malfunction
- Engine Coolant Temperature
- Hydraulic System Malfunction



## STOPPING THE ENGINE AND LEAVING THE LOADER

### Procedure

Stop the loader on level ground.

Fully lower the lift arms and put the attachment flat on the ground.

Figure 123



Set the engine speed control to the low idle position [Figure 123].

Engage the parking brake.

Figure 124

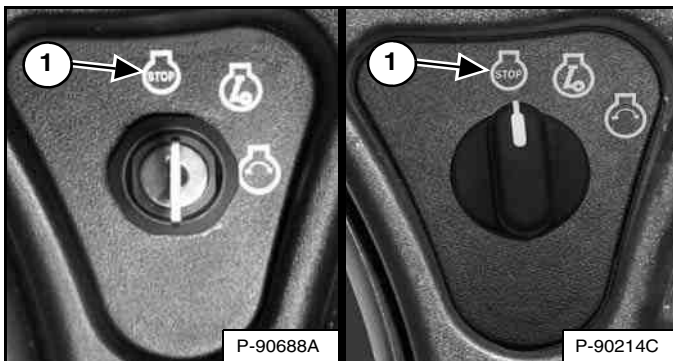

Turn the key switch to the STOP position (Item 1) [Figure 124].

**NOTE:** If the loader lights are ON, they will remain ON for approximately 90 seconds after turning the loader OFF.

**NOTE:** The cooling fans in the rear door may continue to operate for several minutes.

Raise the seat bar and make sure the lift and tilt functions are deactivated.

Unbuckle the seat belt.

**(Standard Key Panel)** Remove the key from the switch to prevent operation of the loader by unauthorised personnel.

**NOTE:** Activating the Password Lockout Feature on machines with the Keyless Start Panel or the Deluxe Instrumentation Panel allows operation of the loader without using a password. (See Password Lockout Feature on Page 208.) or (See Password Lockout Feature on Page 210.)

Figure 125



Exit the loader using grab handles, safety tread, and steps (maintaining a three-point contact) [Figure 125].

## WARNING

### AVOID INJURY OR DEATH

Before you leave the operator's seat:

- Lower the lift arms and put the attachment flat on the ground.
- Stop the engine.
- Engage the parking brake.
- Raise the seat bar.
- Move all controls to the NEUTRAL / LOCKED position to make sure the lift, tilt and traction drive functions are deactivated.

The seat bar system must deactivate these functions when the seat bar is up. See your Bobcat dealer for service if controls do not deactivate.

W-2463-1110



## COUNTERWEIGHTS

### Description

Counterweights can be installed on the loader. See your Bobcat dealer for information about approved loader counterweights and configurations for your job application and attachment.

### Effect On The Loader And Loader Operation

Proper operation of the loader and attachment does not change if counterweights are installed on this loader. Always follow the instructions provided in this manual when operating your loader with counterweights installed.

Counterweights installed on your loader can affect the loader and its operation in some applications. Some examples are:

- Increased machine weight.
- Increased Rated Operating Capacity (ROC).
- Harder steering.
- Accelerated or uneven track wear.
- Increased power consumption.

### When To Consider Using Counterweights

Install counterweights to increase the loaders Rated Operating Capacity (ROC) which could improve attachment performance in some applications. Some examples are:

- Using pallet fork with palletised loads.
- Using grapples or bale fork.
- Using buckets to handle loose material without digging.

### When To Consider Removing Counterweights

Remove counterweights to increase the downward force of the attachment for better attachment performance in some applications. Some examples are:

- Digging with buckets.
- Using Hydraulic Breakers, Scrapers, or Landplanes.

### Accessories That Affect Machine Weight

If your loader is already equipped with accessories like Water Tanks or Rear Stabilisers; installing counterweights may not be necessary.

See your Bobcat dealer for more information about the proper use of counterweights with approved attachments and accessories for your loader.

**ATTACHMENTS**

**Choosing The Correct Bucket**



**AVOID INJURY OR DEATH**

Never use attachments or buckets which are not approved by Bobcat Company. Buckets and attachments for safe loads of specified densities are approved for each model. Unapproved attachments can cause injury or death.

W-2052-0907

**NOTE: Warranty is void if non-approved attachments are used on the Bobcat loader.**

The dealer can identify, for each model loader, the attachments and buckets approved by Bobcat. The buckets and attachments are approved for Rated Operating Capacity (ROC) and for secure fastening to the Bob-Tach.

The ROC for this loader is shown on a decal in the operator cab. (See Performance on Page 214.)

**NOTE: The ROC of a loader can be different depending on the undercarriage the loader is equipped with.**

The ROC is determined by using a bucket and material of normal density, such as dirt or dry gravel. If longer buckets are used, the load centre moves forward and reduces the ROC. If extremely dense material is loaded, the volume must be reduced to prevent overloading.

**Figure 126**

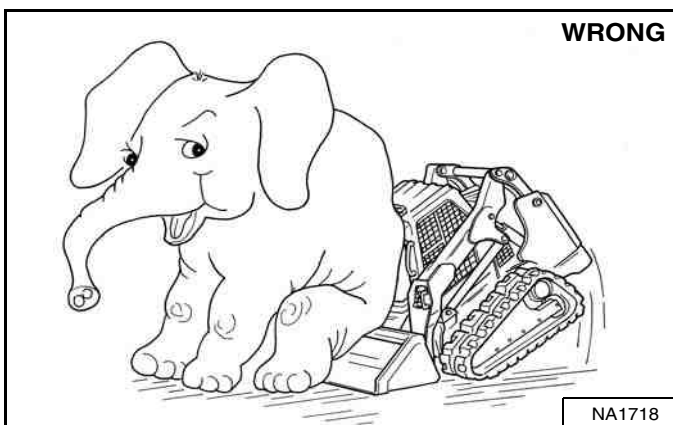

Exceeding the ROC [Figure 126] can cause the following problems:

- Steering the loader may be difficult.
- Tracks will wear faster.
- There will be a loss of stability.
- The life of the Bobcat loader will be reduced.

Use the correct bucket size for the type and density of material being handled. For safe handling of materials and avoiding machine damage, the attachment (or bucket) should handle a full load without going over the ROC for the loader. Partial loads make steering more difficult.

**Pallet Fork**

**Figure 127**

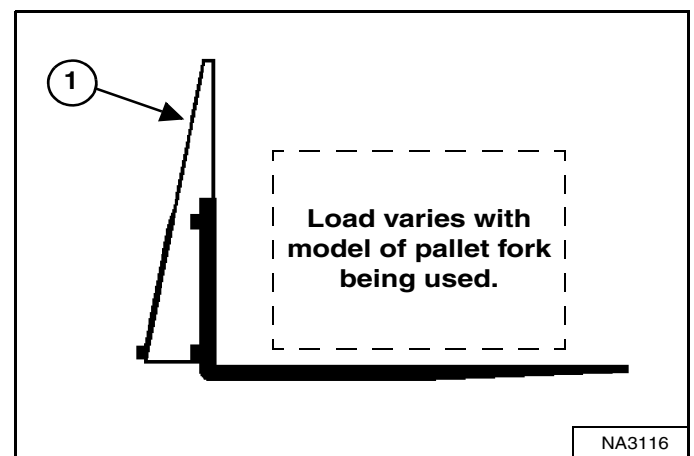

The maximum load to be carried when using a pallet fork is shown on a decal located on the pallet fork frame (Item 1) [Figure 127].

See your Bobcat dealer for more information about pallet fork inspection, maintenance, and replacement. See your Bobcat dealer for ROC when using a pallet fork and for other available attachments.



**AVOID INJURY OR DEATH**

**Do not exceed Rated Operating Capacity (ROC). Excessive load can cause tipping or loss of control.**

W-2053-0903

## ATTACHMENTS (CONT'D)

### Installing And Removing The Attachment (Hand Lever Bob-Tach)

The Bob-Tach is used for fast changing of buckets and attachments. See the appropriate attachment Operation & Maintenance Manual to install other attachments.

#### Installing

Figure 128

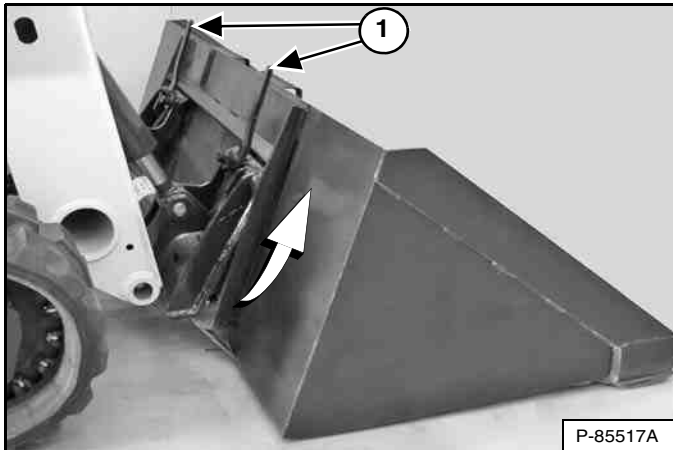

Pull the Bob-Tach levers up until they are fully raised (wedges fully raised) (Item 1) [Figure 128].

Enter the loader and perform the PRE-STARTING PROCEDURE. (See PRE-STARTING PROCEDURE on Page 91.)

Start the engine, press the PRESS TO OPERATE LOADER button, and release the parking brake.

Lower the lift arms and tilt the Bob-Tach forward.

Drive the loader slowly forward until the top edge of the Bob-Tach is completely under the top flange of the bucket mounting frame [Figure 128] (or other attachment).

**NOTE** Be sure the Bob-Tach levers do not hit the attachment.

Figure 129

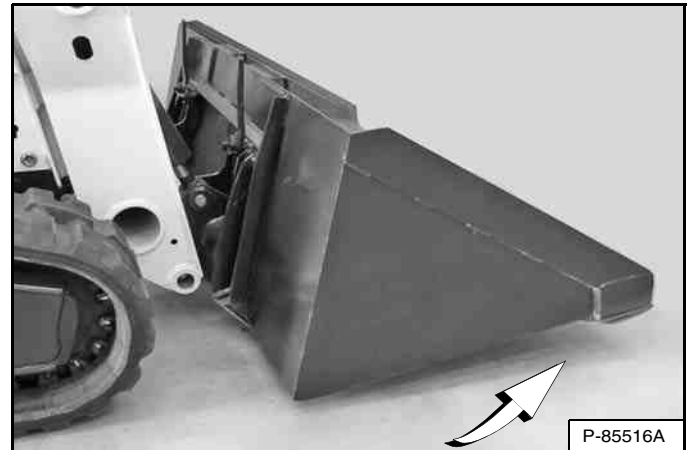

Tilt the Bob-Tach backward until the cutting edge of the bucket (or other attachment) is slightly off the ground [Figure 129]. This procedure will cause the bucket mounting frame to fit up against the front of the Bob-Tach.

Stop the engine and exit the loader. (See STOPPING THE ENGINE AND LEAVING THE LOADER on Page 103.)

## **WARNING**

### AVOID INJURY OR DEATH

Before you leave the operator's seat:

- Lower the lift arms and put the attachment flat on the ground.
- Stop the engine.
- Engage the parking brake.
- Raise the seat bar.
- Move all controls to the NEUTRAL / LOCKED position to make sure the lift, tilt and traction drive functions are deactivated.

The seat bar system must deactivate these functions when the seat bar is up. See your Bobcat dealer for service if controls do not deactivate.

W-2463-1110

ATTACHMENTS (CONT'D)

Installing And Removing The Attachment (Hand Lever Bob-Tach) (Cont'd)

Installing (Cont'd)

Figure 130

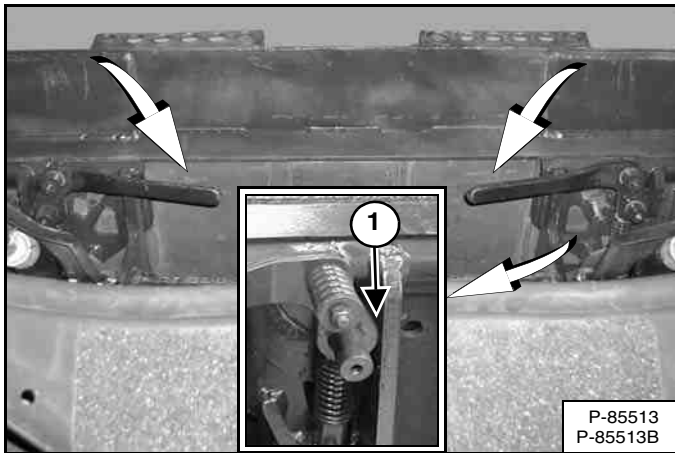

Push down on the Bob-Tach levers until they are fully engaged in the locked position [Figure 130] (wedges fully extended through the attachment mounting frame holes).

Both levers must contact the frame as shown when locked (Item 1) [Figure 130].

If both levers do not engage in the locked position, see your Bobcat dealer for maintenance.

Figure 131

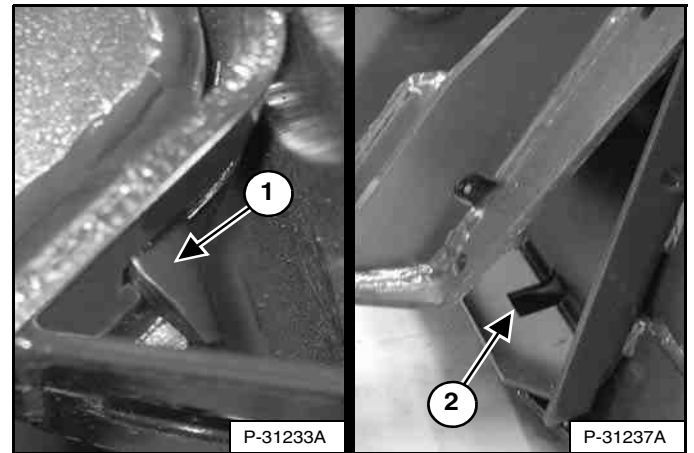

The wedges (Item 1) must extend through the holes (Item 2) [Figure 131] in the mounting frame of the bucket (or other attachment), securely fastening the bucket to the Bob-Tach.

**! WARNING**

**AVOID INJURY OR DEATH**

The Bob-Tach wedges must extend through the holes in the attachment mounting frame. Levers must be fully down and locked. Failure to secure wedges can allow attachment to come off.

W-2715-0208

**ATTACHMENTS (CONT'D)**

**Installing And Removing The Attachment (Hand Lever Bob-Tach) (Cont'd)**

*Removing*

Lower the lift arms and put the attachment flat on the ground. Lower or close any hydraulic equipment, if applicable.

Stop the engine and exit the loader. (See STOPPING THE ENGINE AND LEAVING THE LOADER on Page 103.)



**AVOID INJURY OR DEATH**

**Before you leave the operator's seat:**

- Lower the lift arms and put the attachment flat on the ground.
- Stop the engine.
- Engage the parking brake.
- Raise the seat bar.
- Move all controls to the **NEUTRAL / LOCKED** position to make sure the lift, tilt and traction drive functions are deactivated.

The seat bar system must deactivate these functions when the seat bar is up. See your Bobcat dealer for service if controls do not deactivate.

W-2463-1110

Disconnect attachment electrical harness and water or hydraulic lines, if applicable, from the loader. (See Relieve Auxiliary Hydraulic Pressure (Loader And Attachment) on Page 87.)

**Figure 132**

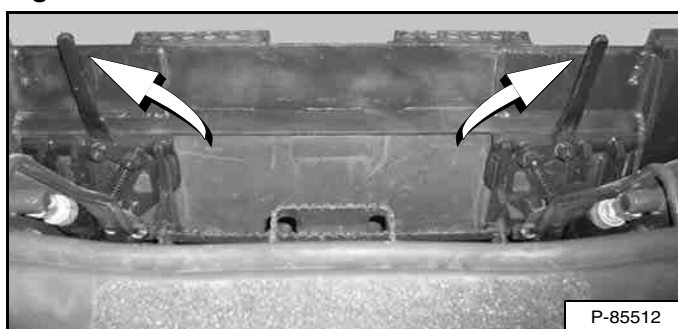

Pull the Bob-Tach levers up [Figure 132] until they are fully raised (wedges fully raised).



**Bob-Tach levers have spring tension. Hold lever tightly and release slowly. Failure to obey warning can cause injury.**

W-2054-1285

Enter the loader and perform the PRE-STARTING PROCEDURE. (See PRE-STARTING PROCEDURE on Page 91.)

Start the engine, press the PRESS TO OPERATE LOADER button, and release the parking brake.

**Figure 133**

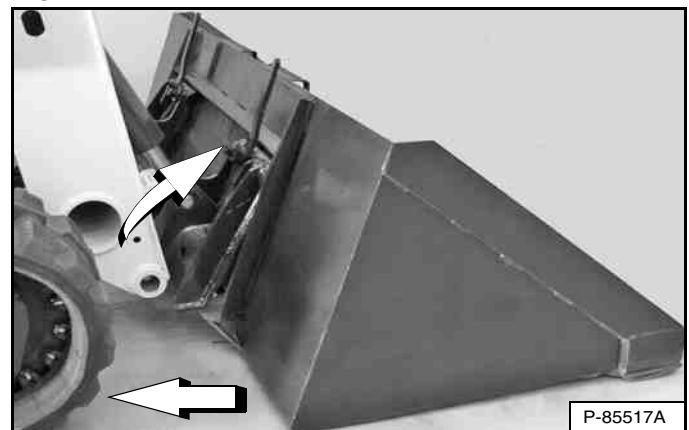

Tilt the Bob-Tach forward and drive the loader backward, away from the bucket or attachment [Figure 133].

## ATTACHMENTS (CONT'D)

### Installing And Removing The Attachment (Power Bob-Tach)

This machine may be equipped with a Power Bob-Tach.

The Power Bob-Tach is used for fast changing of buckets and attachments. See the appropriate attachment Operation & Maintenance Manual to install other attachments.

#### Installing

Enter the loader and perform the PRE-STARTING PROCEDURE. (See PRE-STARTING PROCEDURE on Page 91.)

Start the engine, press the PRESS TO OPERATE LOADER button, and release the parking brake.

Lower the lift arms and tilt the Bob-Tach forward.

Figure 134

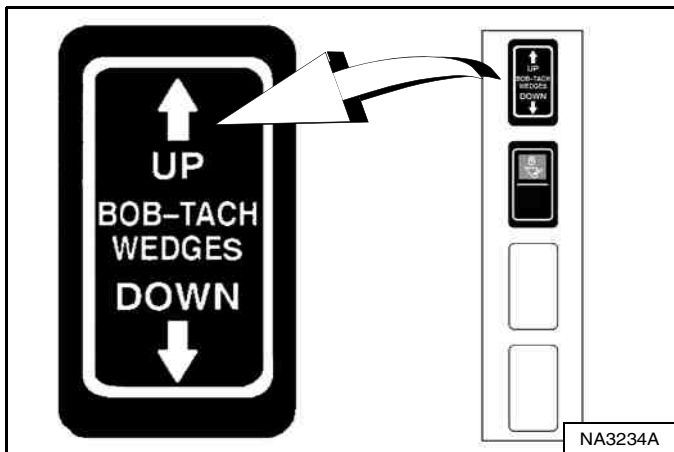
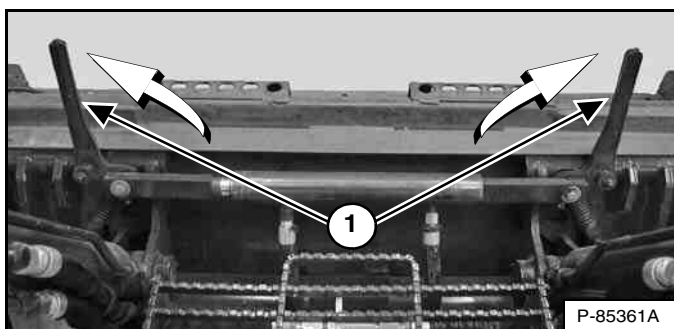
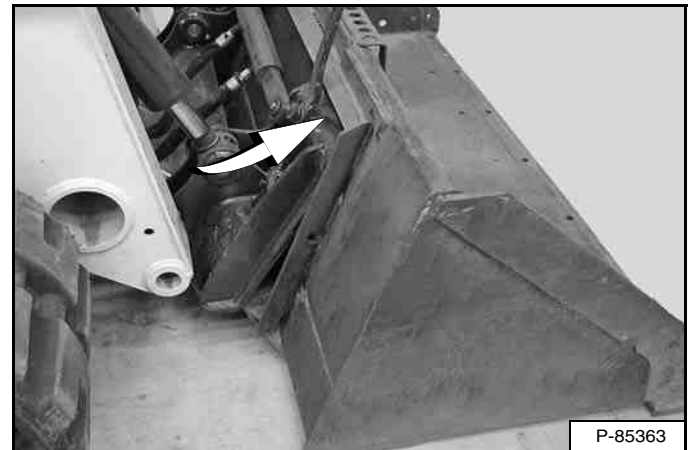

Figure 135



Push and hold BOB-TACH WEDGES “UP” switch (Right Switch Panel) [Figure 134] until levers (Item 1) [Figure 135] are fully raised (wedges fully raised).

Figure 136



Drive the loader slowly forward until the top edge of the Bob-Tach is completely under the top flange of the bucket mounting frame [Figure 136] (or other attachment).

**NOTE:** Be sure the Bob-Tach levers do not hit the attachment.

Figure 137

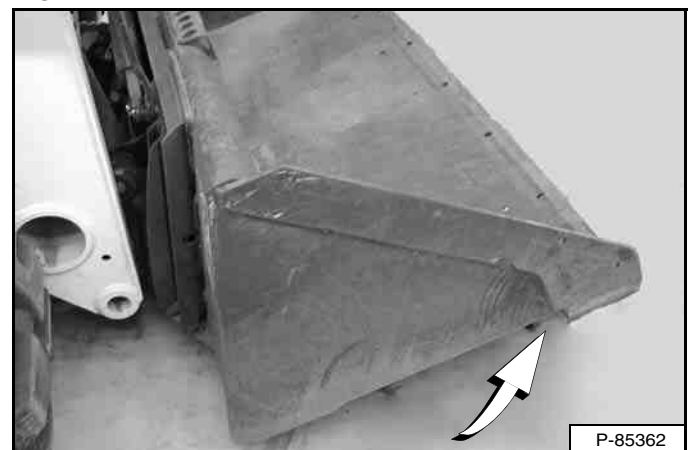

Tilt the Bob-Tach backward until the cutting edge of the bucket (or other attachment) is slightly off the ground [Figure 137]. This procedure will cause the bucket mounting frame to fit up against the front of the Bob-Tach.

ATTACHMENTS (CONT'D)

Installing And Removing The Attachment (Power Bob-Tach) (Cont'd)

Installing (Cont'd)

Figure 138

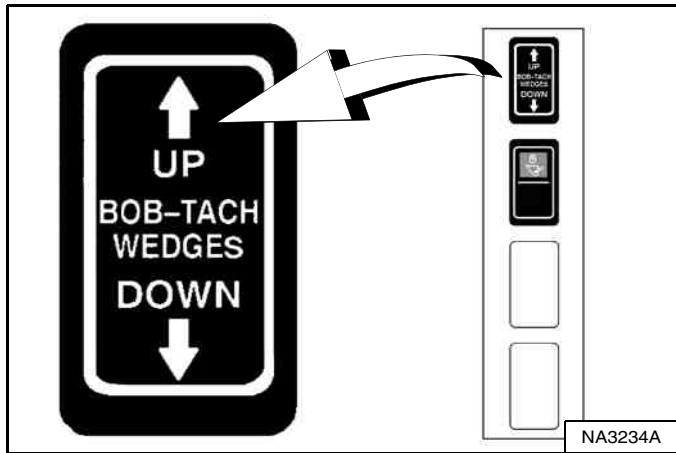

Push and hold BOB-TACH WEDGES “UP” switch (Right Switch Panel) [Figure 138] to make sure the levers are fully raised (wedges fully raised).

**NOTE:** The Power Bob-Tach system uses continuously pressurised hydraulic fluid to keep the wedges in the engaged position and prevent attachment disengagement. Because the wedges can slowly lower, the operator may need to reactivate the switch (BOB-TACH WEDGES “UP”) to be sure both wedges are fully raised before installing the attachment.

Figure 139

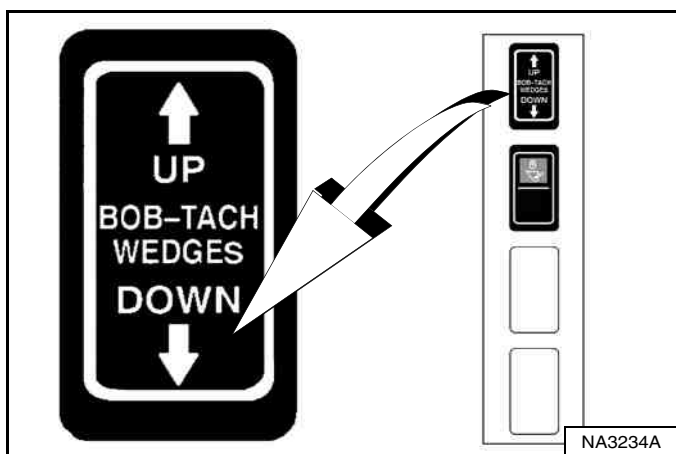
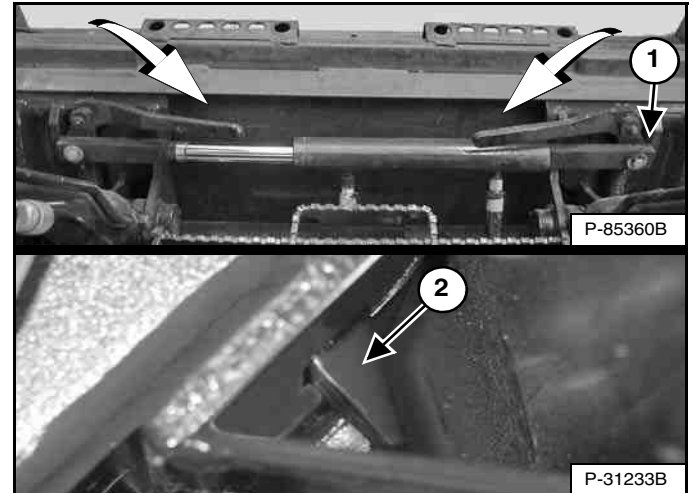

Figure 140



Push and hold BOB-TACH WEDGES “DOWN” switch (Right Switch Panel) [Figure 139] until levers are fully engaged in the locked position [Figure 140] (wedges fully extended through the attachment mounting frame holes).

Both levers must contact the frame as shown when locked (Item 1) [Figure 140].

If both levers do not engage in the locked position, see your Bobcat dealer for maintenance.

The wedges (Item 2) [Figure 140] must extend through the holes in the mounting frame of the bucket (or other attachment), securely fastening the bucket to the Bob-Tach.



**AVOID INJURY OR DEATH**

The Bob-Tach wedges must extend through the holes in the attachment mounting frame. Levers must be fully down and locked. Failure to secure wedges can allow attachment to come off.

W-2715-0208



## ATTACHMENTS (CONT'D)

### Installing And Removing The Attachment (Power Bob-Tach) (Cont'd)

#### Removing

Lower the lift arms and put the attachment flat on the ground. Lower or close any hydraulic equipment, if applicable.

If the attachment has electrical, water, or hydraulic connections to the loader:

1. Stop the engine and exit the loader. (See STOPPING THE ENGINE AND LEAVING THE LOADER on Page 103.)



#### AVOID INJURY OR DEATH

Before you leave the operator's seat:

- Lower the lift arms and put the attachment flat on the ground.
- Stop the engine.
- Engage the parking brake.
- Raise the seat bar.
- Move all controls to the NEUTRAL / LOCKED position to make sure the lift, tilt and traction drive functions are deactivated.

The seat bar system must deactivate these functions when the seat bar is up. See your Bobcat dealer for service if controls do not deactivate.

W-2463-1110

2. Disconnect attachment electrical harness and water or hydraulic lines, if applicable, from the loader. (See Relieve Auxiliary Hydraulic Pressure (Loader And Attachment) on Page 87.)
3. Enter the loader and perform the PRE-STARTING PROCEDURE. (See PRE-STARTING PROCEDURE on Page 91.)
4. Start the engine, press the PRESS TO OPERATE LOADER button, and release the parking brake.

Figure 141

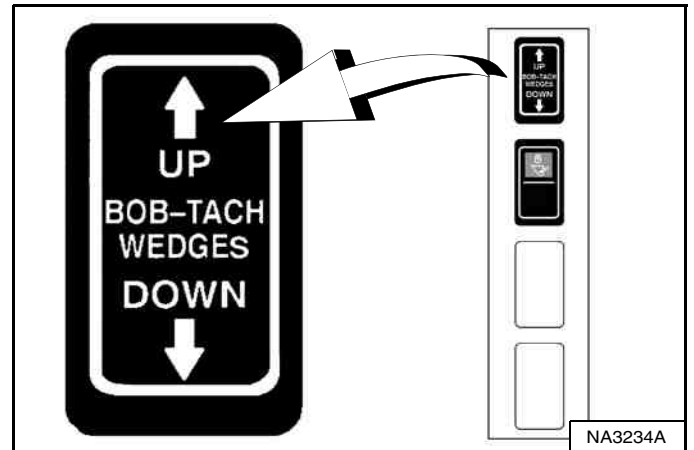

Push and hold BOB-TACH WEDGES "UP" switch (Right Switch Panel) [Figure 141] until levers are fully raised (wedges fully raised).

Figure 142

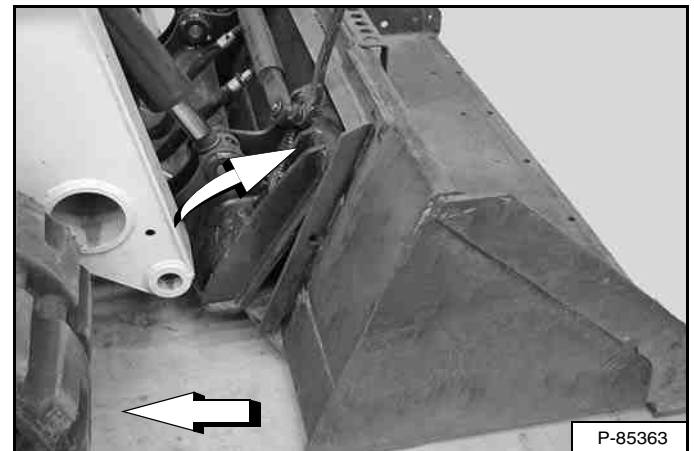

Tilt the Bob-Tach forward and drive the loader backward, away from the bucket or attachment [Figure 142].

**NOTE:** The Power Bob-Tach system uses continuously pressurised hydraulic fluid to keep the wedges in the engaged position and prevent attachment disengagement. Because the wedges can slowly lower, the operator may need to reactivate the switch (BOB-TACH WEDGES "UP") when removing an attachment to be sure both wedges are fully raised.

## TRACK UNDERCARRIAGE SYSTEM

### Introduction

There are many advantages of a Bobcat compact track loader. They provide very high flotation, low ground pressure, turf friendly rubber tracks, and excellent traction.

### Compact Track Loader Operating And Maintenance Tips

**Track Tension:** Correct track tension is important. If the tracks are too loose, they can easily derail. If they are too tight, they will wear faster and cause increased stress on the complete track carriage system. (See TRACK TENSION on Page 171.)

Figure 143

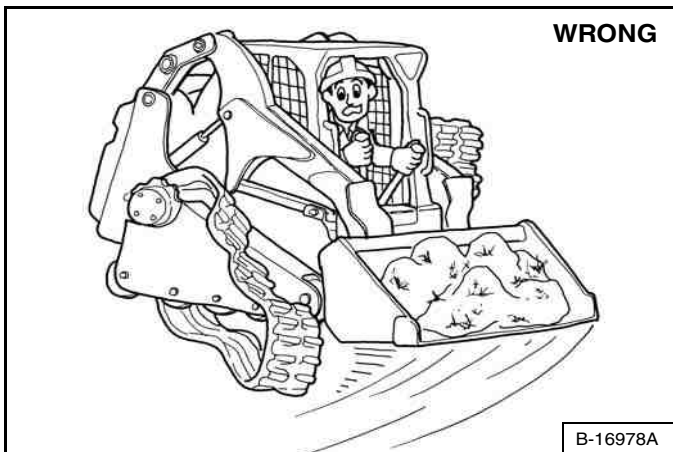

**Turning:** Use a gradual turn (one control farther forward than the other) instead of a fast turn (one control forward and one control backward) on asphalt or concrete surfaces to prevent reduced track life or derailing of the tracks [Figure 143].

Always carry the load low.

Figure 144

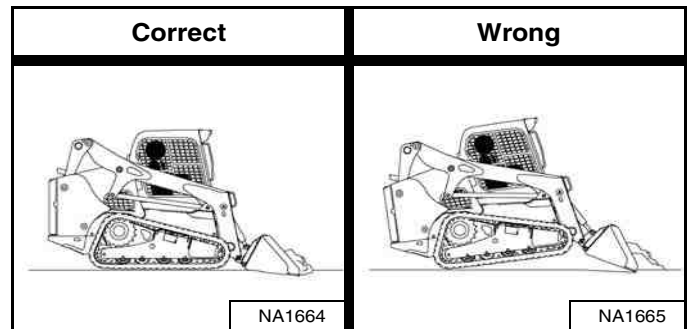

**Digging And Levelling:** Keep the full length of the tracks in contact with the ground [Figure 144] for best traction.

Raising the front end of the tracks off the ground [Figure 144] will reduce traction and cause increased track wear.

**Operating On Slopes:** Go directly up or down a slope, not across the slope, to prevent tracks from derailing.

Figure 145

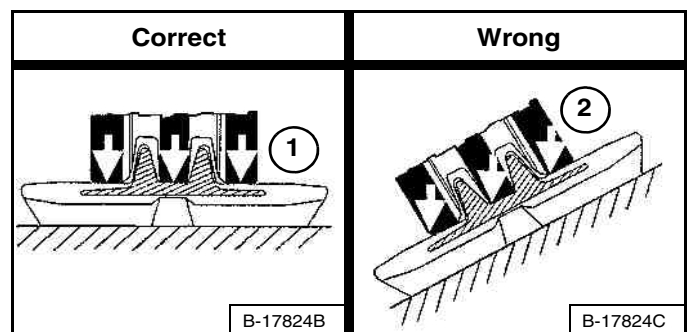

The track carriage components will wear faster when operated on a slope. When the machine is operated on a level surface, the weight of the machine is distributed throughout the entire surface of the rollers to the tracks (Item 1). When operated on a slope, the weight is directed to the edge of the rollers and against the lugs of the track (Item 2) [Figure 145] which causes increased wear.

**TRACK UNDERCARRIAGE SYSTEM (CONT'D)**

**Compact Track Loader Operating And Maintenance Tips (Cont'd)**

**Figure 146**

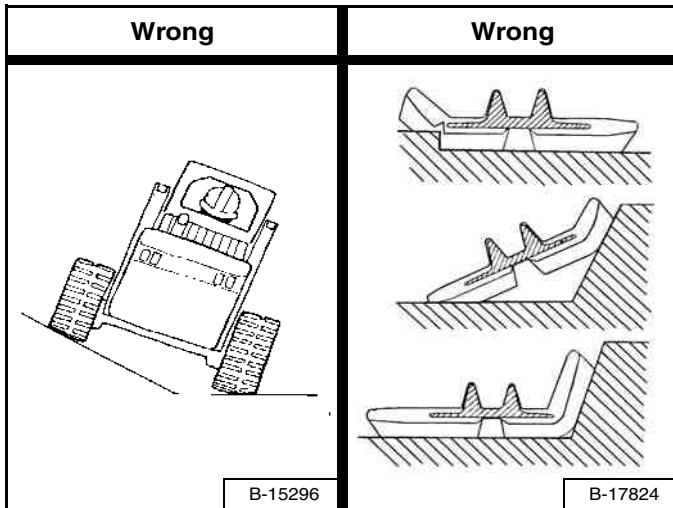

**Operating Conditions:** Avoid operating the loader with one track on a slope and the other on flat ground or with the end of the track turned up against a curb or mound [Figure 146]. This can cause the tracks to derail, cracks in the edge of the tracks, or cracks at the edges of the embedded metal.

**Figure 147**

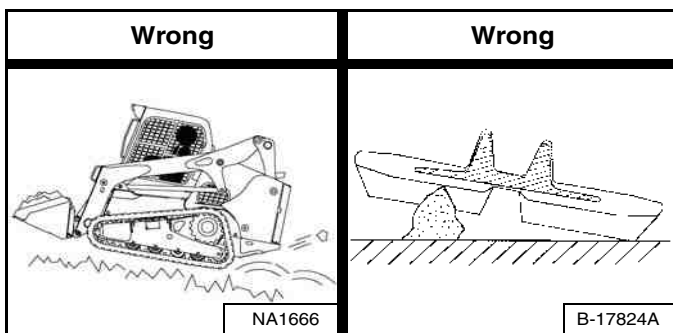

Avoid operating or turning on sharp objects such as jagged rocks, broken concrete, quarry materials, or scrap applications. This can cause cuts on the lug surface of the tracks [Figure 147].

**Cleaning And Maintenance:** Keep the track carriage system as clean as possible. Remove rocks and debris from the tracks and rollers. Use a pressure washer if necessary.

**Rotating:** The tracks and sprockets should be periodically rotated to the opposite side of the machine. It is important to rotate the tracks and sprockets as a set for maximum service life. See your Bobcat dealer for track and sprocket rotation.

**It's All About The Tracks:**

- Follow operating and maintenance tips.
- Keep the rollers and idlers clean.
- Know what conditions can cause accelerated wear.
- Watch for abnormal wear patterns.
- Replace components and tracks as needed.



## OPERATING PROCEDURE

### Inspect The Work Area

Before beginning operation, inspect the work area for unsafe conditions.

Look for sharp drop-offs or rough terrain. Have underground utility lines (gas, electrical, water, sewer, irrigation, etc.) located and marked.

Remove objects or other construction material that could damage the loader or cause personal injury.

Always check ground conditions before starting your work:

- Inspect for signs of instability such as cracks or settlement.
- Be aware of weather conditions that can affect ground stability.
- Check for adequate traction if working on a slope.

### Basic Operating Instructions

Always warm the engine and hydrostatic system before operating the loader.

## IMPORTANT

**Machines warmed up with moderate engine speed and light load have longer life.**

I-2015-0284

Operate the loader with engine at full speed for maximum horsepower. Move the steering controls only a small amount to operate the loader slowly.

New operators must operate the loader in an open area without bystanders. Operate the controls until the loader can be handled at an efficient and safe rate for all conditions of the work area.

### Operating Near An Edge Or Water

Keep the loader as far back from the edge as possible and the loader tracks perpendicular to the edge so that if part of the edge collapses, the loader can be moved back.

Always move the loader back at any indication the edge may be unstable.

## **WARNING**

### **MACHINE TIPPING OR ROLLOVER CAN CAUSE SERIOUS INJURY OR DEATH**

- **Keep the lift arms as low as possible.**
- **Do not travel or turn with the lift arms up.**
- **Turn on level ground. Slow down when turning.**
- **Go up and down slopes, not across them.**
- **Keep the heavy end of the machine uphill.**
- **Do not overload the machine.**
- **Check for adequate traction.**

W-2018-1112

### Driving On Public Roads

When operating on a public road or motorway, always follow local regulations. For example: Slow Moving Vehicle Sign or direction signals may be required.

**NOTE: Road kits are available from your Bobcat dealer to equip your machine for driving on public roads in European Union (EU) countries.**

**Always follow local regulations. For more information, contact your local Bobcat dealer.**

**OPERATING PROCEDURE (CONT'D)**

**Operating With A Full Bucket**

**Figure 148**

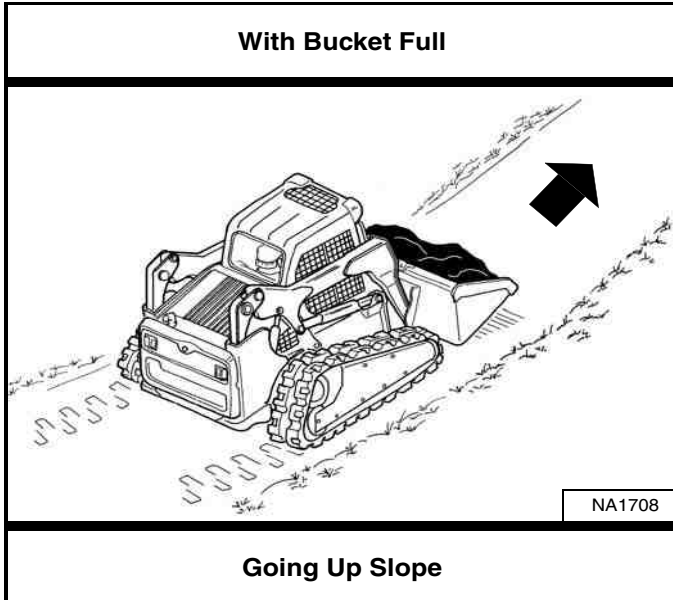

**Operating With An Empty Bucket**

**Figure 150**

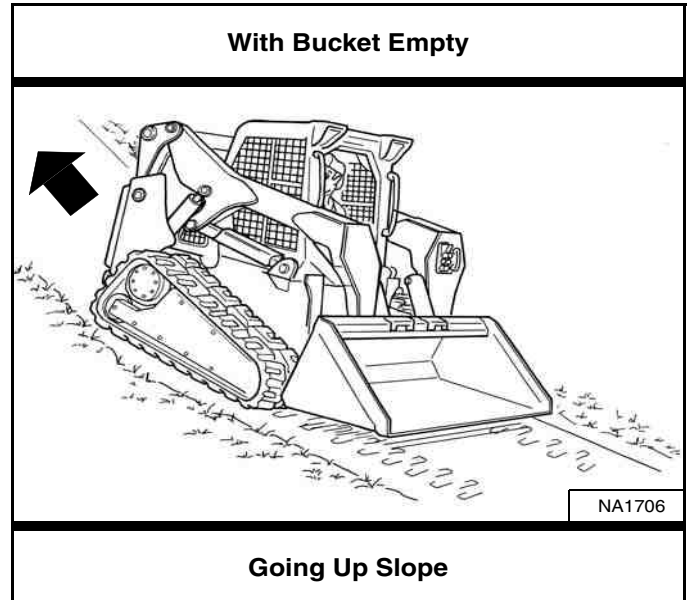

**Figure 149**

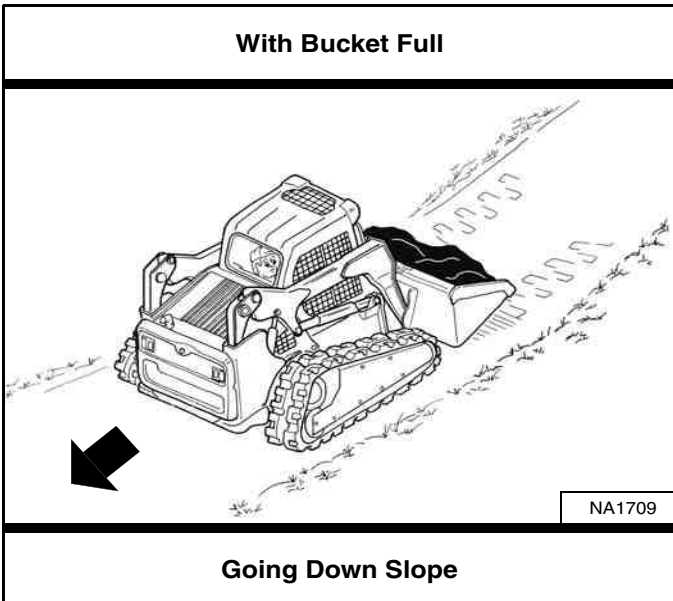

**Figure 151**

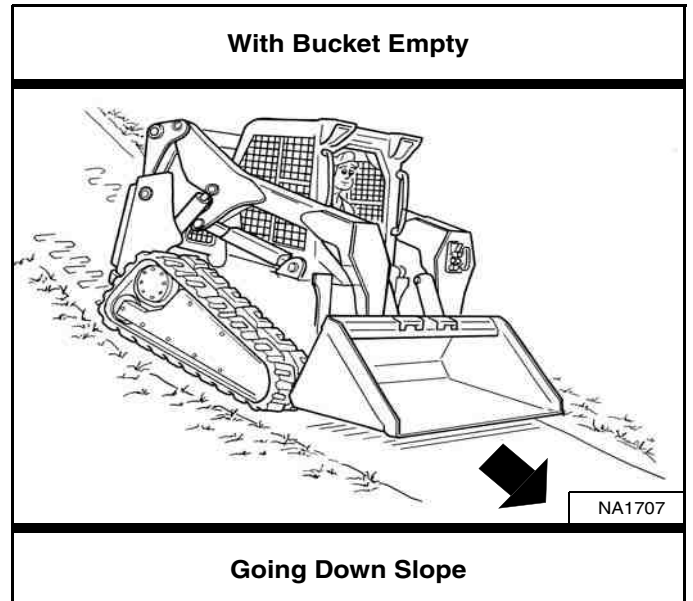

With a full bucket, go up or down the slope with the heavy end toward the top of the slope [Figure 148] and [Figure 149].

Raise the bucket only high enough to avoid obstructions on rough ground.

With an empty bucket, go up or down the slope with the heavy end toward the top of the slope [Figure 150] and [Figure 151].

Raise the bucket only high enough to avoid obstructions on rough ground.

## TOWING THE LOADER

### Procedure

Because of the design of the loader, there is not a recommended towing procedure.

- The loader can be lifted onto a transport vehicle.
- The loader can be skidded a short distance to move for service (EXAMPLE: Move onto a transport vehicle.) without damage to the hydrostatic system. (The tracks will not turn.) There may be slight wear to the tracks when the loader is skidded.

The towing chain (or cable) must be rated at 1.5 times the weight of the loader. (See Performance on Page 214.)

## LIFTING THE LOADER

### Single-Point Lift

# ! WARNING

### AVOID INJURY OR DEATH

- **Before lifting, check fasteners on single point lift and operator cab.**
- **Assemble front cab fasteners as shown in this manual.**
- **Never allow riders in the cab or bystanders within 5 m (15 ft) while lifting the machine.**

W-2007-0910

The loader can be lifted with the Single-Point Lift that is available as a kit from your Bobcat loader dealer.

The Single-Point Lift, supplied by Bobcat, is designed to lift and support the Bobcat loader without affecting roll-over and falling object protection features of the operator cab.

Figure 152

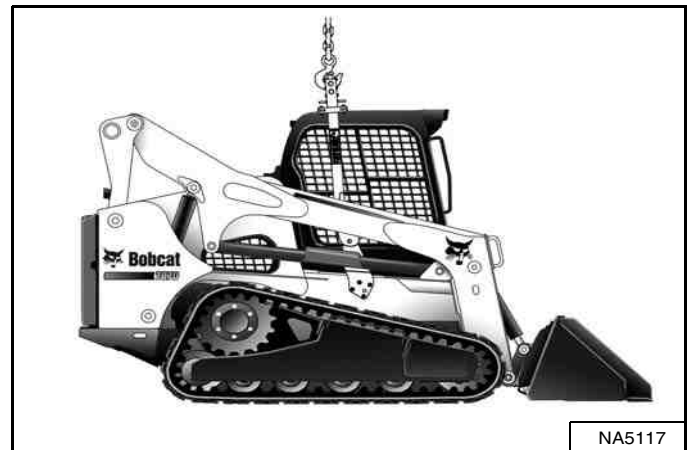

Attach lift to lift eye [Figure 152].

**NOTE:** Be sure the lifting equipment is of adequate size and capacity for the weight of the loader. (See Performance on Page 214.)

LIFTING THE LOADER (CONT'D)

Four-Point Lift



**AVOID INJURY OR DEATH**

- Before lifting, check fasteners on four point lift.
- Never allow riders in the cab or bystanders within 5 m (15 ft) while lifting the machine.

W-2160-0910

The loader can be lifted with the Four-Point Lift that is available as a kit from your Bobcat loader dealer.

Figure 153

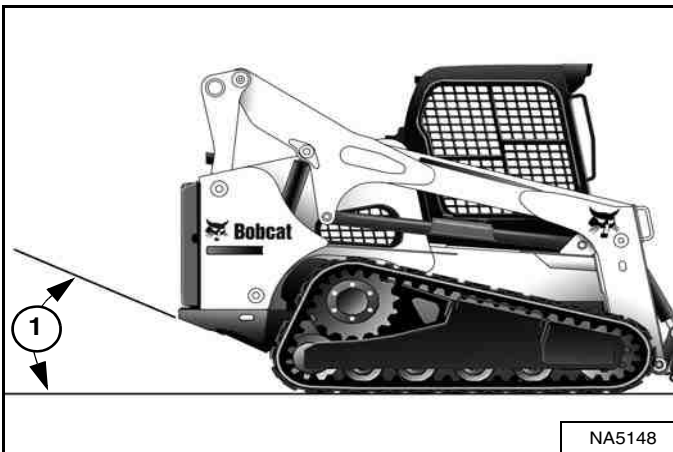

**NOTE:** The loader should be lifted as close to horizontal as possible, but at no time should the angle of the suspended loader exceed the departure angle (Item 1) [Figure 153] provided in the specifications section. (See Machine Dimensions on Page 213.)

Figure 154

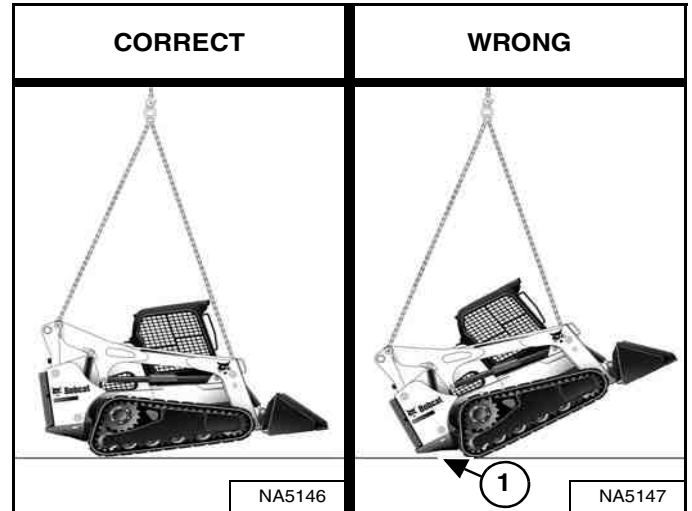

Attach cables or chains to lift eyes [Figure 154].

**NOTE:** Sling legs should not contact any part of the operator cab or lift arms to prevent damage.

**NOTE:** The required length of front and rear sling legs may or may not be equal depending on loader configuration. Departure angle (Item 1) [Figure 154] in this view has been exceeded, sling leg length must be adjusted to prevent this situation.

**NOTE:** Be sure the lifting equipment is of adequate size and capacity for the weight of the loader. (See Performance on Page 214.)

## TRANSPORTING THE LOADER ON A TRAILER

### Loading And Unloading

# ⚠ WARNING

### AVOID SERIOUS INJURY OR DEATH

Adequately designed ramps of sufficient strength are needed to support the weight of the machine when loading onto a transport vehicle. Wood ramps can break and cause personal injury.

W-2058-0807

Be sure the transport and towing vehicles are of adequate size and capacity for weight of loader. (See Performance on Page 214.)

**NOTE:** Always disengage the auto idle feature when loading or unloading the loader on a trailer. (See AUTO IDLE on Page 60.)

Figure 155



A loader with an empty bucket or no attachment must be loaded backward onto the transport vehicle [Figure 155].

The rear of the trailer must be blocked or supported (Item 1) [Figure 155] when loading or unloading the loader to prevent the front end of the trailer from raising up.

### Fastening

Figure 156

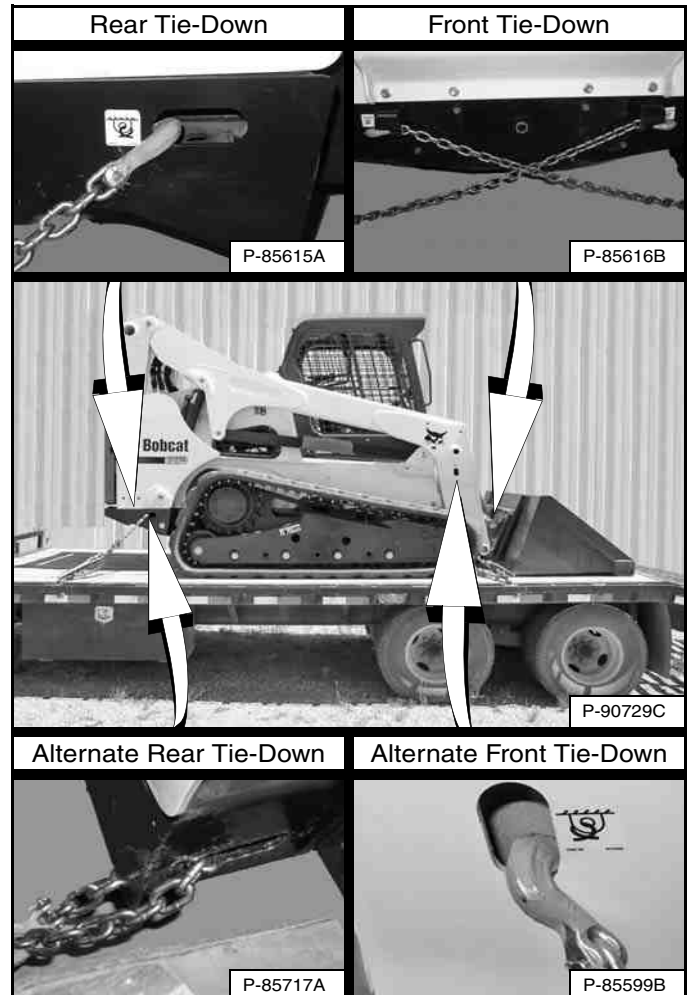

Use the following procedure to fasten the Bobcat loader to the transport vehicle to prevent the loader from moving during sudden stops, or when going up or down slopes [Figure 156].

1. Lower the bucket or attachment to the floor.
2. Stop the engine.
3. Engage the parking brake.
4. Install chains at the front and rear loader tie-down positions [Figure 156]. (Lift arms shown raised for visual clarity.)
5. Fasten each end of the chain to the transport vehicle.
6. Use chain binders to tighten the chains.





**PREVENTIVE MAINTENANCE**

MAINTENANCE SAFETY ..... 122

SERVICE SCHEDULE ..... 123

    Maintenance Intervals ..... 123

    Inspection Checkbook ..... 125

BOBCAT INTERLOCK CONTROL SYSTEM (BICS™) ..... 126

    Inspecting The BICS™ (Engine STOPPED – Key ON) ..... 126

    Inspecting Deactivation Of The Auxiliary Hydraulics System (Engine STOPPED – Key ON) ..... 126

    Inspecting The Seat Bar Sensor (Engine RUNNING) ..... 126

    Inspecting The Traction Lock And Parking Brake (Engine RUNNING) ..... 126

    Inspecting The Lift Arm Bypass Control ..... 126

    Inspecting Deactivation Of Lift And Tilt Functions ..... 126

SEAT BAR RESTRAINT SYSTEM ..... 127

    Description ..... 127

    Inspection And Maintenance ..... 127

SEAT BELT ..... 128

    Inspection And Maintenance ..... 128

LIFT ARM SUPPORT DEVICE ..... 129

    Description ..... 129

    Installing ..... 130

    Removing ..... 131

BACK-UP ALARM SYSTEM ..... 132

    Description ..... 132

    Inspection ..... 132

OPERATOR CAB ..... 133

    Description ..... 133

    Cab Door Sensor ..... 133

    Raising ..... 134

    Lowering ..... 135

REAR DOOR (TAILGATE) ..... 136

    Opening And Closing ..... 136

    Adjusting Latch ..... 136

REAR GRILLE ..... 137

    Removing ..... 137

    Installing ..... 137

HEATING, VENTILATION, AND AIR CONDITIONING (HVAC) SYSTEM ..... 138

    Filters ..... 138

    Air Conditioning Evaporator / Heater Coil ..... 139

    Air Conditioning Condenser ..... 140

    Air Conditioning Lubrication ..... 140

    Troubleshooting ..... 140



ENGINE AIR CLEANER .....	141
Replacing Filters .....	141
FUEL SYSTEM .....	143
Fuel Specifications .....	143
Biodiesel Blend Fuel .....	143
Filling The Fuel Tank .....	144
Fuel Filter .....	145
Removing Air From The Fuel System .....	146
DIESEL EXHAUST FLUID (DEF) / ADBLUE® SYSTEM .....	147
Description .....	147
Filling The DEF / AdBlue® Tank .....	147
ENGINE LUBRICATION SYSTEM .....	148
Checking And Adding Engine Oil .....	148
Engine Oil Chart .....	148
Removing And Replacing Oil And Filter .....	149
ENGINE COOLING SYSTEM .....	151
Maintenance Platform .....	151
Cleaning .....	151
Checking And Adding Coolant .....	154
Removing And Replacing Coolant .....	155
ELECTRICAL SYSTEM .....	157
Description .....	157
Fuse And Relay Location / Identification .....	157
Battery Maintenance .....	162
Using A Booster Battery (Jump Starting) .....	163
Removing And Installing Battery .....	164
HYDRAULIC / HYDROSTATIC SYSTEM .....	165
Checking And Adding Fluid .....	165
Hydraulic / Hydrostatic Fluid Chart .....	165
Removing And Replacing Hydraulic Fluid .....	166
Removing And Replacing Hydraulic / Hydrostatic Filter .....	168
Removing And Replacing Hydraulic Charge Filter .....	169
Replacing Reservoir Breather Cap .....	170
TRACK TENSION .....	171
Description .....	171
Checking .....	171
Adjusting (Earlier Models With Two Track Tension Fittings) .....	172
Adjusting (Later Models With One Track Tension Fitting) .....	173
HYDROSTATIC DRIVE MOTOR .....	174
Removing And Replacing Oil .....	174
TRACK SPROCKET MAINTENANCE .....	174
Tightening Procedure .....	174



ALTERNATOR BELT .....	175
Belt Adjustment .....	175
Belt Replacement .....	175
AIR CONDITIONING BELT .....	176
Belt Adjustment .....	176
Belt Replacement .....	176
DRIVE BELT .....	178
Belt Adjustment .....	178
Stop Adjustment .....	178
Belt Replacement .....	179
AUTOMATIC RIDE CONTROL ACCUMULATOR .....	181
Checking Accumulator Charge .....	181
LUBRICATING THE LOADER .....	182
Lubrication Locations .....	182
TRACK ROLLER AND IDLER LUBRICATION .....	185
Procedure .....	185
PIVOT PINS .....	185
Inspection And Maintenance .....	185
BOB-TACH (HAND LEVER) .....	186
Inspection And Maintenance .....	186
BOB-TACH (POWER) .....	187
Inspection And Maintenance .....	187
LOADER STORAGE AND RETURN TO SERVICE .....	188
Storage .....	188
Return To Service .....	188

# MAINTENANCE SAFETY

## WARNING

Instructions are necessary before operating or servicing machine. Read and understand the Operation & Maintenance Manual, Operator's Handbook and signs (decals) on machine. Follow warnings and instructions in the manuals when making repairs, adjustments or servicing. Check for correct function after adjustments, repairs or service. Untrained operators and failure to follow instructions can cause injury or death.

W-2003-0807

**Safety Alert Symbol:** This symbol with a warning statement, means: "Warning, be alert! Your safety is involved!" Carefully read the message that follows.

CORRECT

P-90216

**Never service the Bobcat Skid-Steer Loader without instructions.**

CORRECT

NA1711

**Use the correct procedure to lift or lower operator cab.**

CORRECT

NA1715

**Cleaning and maintenance are required daily.**

WRONG

NA1714

**Have good ventilation when welding or grinding painted parts.**

**Wear dust mask when grinding painted parts. Toxic dust and gas can be produced.**

**Avoid exhaust fume leaks which can kill without warning. Exhaust system must be tightly sealed.**

WRONG

NA1710

**Disconnecting or loosening any hydraulic tubeline, hose, fitting, component or a part failure can cause lift arms to drop. Do not go under lift arms when raised unless supported by an approved lift arm support device. Replace it if damaged.**

WRONG

NA1712

**Never work on loader with lift arms up unless lift arms are held by an approved lift arm support device. Replace if damaged.**

**Never modify equipment or add attachments not approved by Bobcat Company.**

WRONG

NA1722

**Stop, cool and clean engine of flammable materials before checking fluids.**

**Never service or adjust loader with the engine running unless instructed to do so in the manual.**

**Avoid contact with leaking hydraulic fluid or diesel fuel under pressure. It can penetrate the skin or eyes.**

**Never fill fuel tank with engine running, while smoking or when near open flame.**

WRONG

NA1725

**Keep body, jewelry and clothing away from moving parts, electrical contact, hot parts and exhaust.**

**Wear eye protection to guard from battery acid, compressed springs, fluids under pressure and flying debris when engines are running or tools are used. Use eye protection approved for type of welding.**

**Keep rear door closed except for service. Close and latch door before operating the loader.**

WRONG

B-6589

**Lead-acid batteries produce flammable and explosive gases.**

**Keep arcs, sparks, flames and lighted tobacco away from batteries.**

**Batteries contain acid which burns eyes or skin on contact.**

**Wear protective clothing. If acid contacts body, flush well with water. For eye contact flush well and get immediate medical attention.**

Maintenance procedures which are given in the Operation & Maintenance Manual can be performed by the owner/operator without any specific technical training. Maintenance procedures which are **not** in the Operation & Maintenance Manual must be performed **ONLY BY QUALIFIED BOBCAT SERVICE PERSONNEL**. Always use genuine Bobcat replacement parts. The Service Safety Training Course is available from your Bobcat dealer.



## SERVICE SCHEDULE

### Maintenance Intervals

Maintenance work must be done at regular intervals. Failure to do so will result in excessive wear and early failures.

The service schedule is a guide for correct maintenance of the Bobcat loader.

## WARNING

### AVOID INJURY OR DEATH

Instructions are necessary before operating or servicing machine. Read and understand the Operation & Maintenance Manual, Operator's Handbook and signs (decals) on machine. Follow warnings and instructions in the manuals when making repairs, adjustments or servicing. Check for correct function after adjustments, repairs or service. Untrained operators and failure to follow instructions can cause injury or death.

W-2003-0807

### *Every 10 Hours (Before Starting The Loader)*

- **Engine Oil** – Check level and add as needed. (See Page 148.)
- **Engine Air Filters and Air System** – Check display panel. Service only when required. Check for leaks and damaged components. (See Page 141.)
- **Engine Cooling System** – Clean debris from hydraulic fluid cooler and radiator assembly, fuel cooler, air conditioning condenser (if equipped), rear grille, and screens on the rear door and engine cover. Check coolant level COLD and add premixed coolant as needed. (See Page 151.) and (See Page 154.)
- **Fuel Filter** – Check the display panel. Remove the trapped water when required. (See Page 145.)
- **Lift Arms, Lift Links, Cylinders, Bob-Tach, Pivot Pins, Wedges** – Lubricate with multipurpose lithium based grease. (See Page 182.)
- **Seat Belt, Seat Belt Retractors, Seat Bar, Control Interlocks** – Check the condition of seat belt. Clean or replace seat belt retractors as needed. Check the seat bar and control interlocks for correct operation. Clean dirt and debris from moving parts. (See Page 127.) and (See Page 128.)
- **Bobcat Interlock Control Systems (BICS™)** – Check for correct function. Lift and Tilt functions MUST NOT operate with seat bar raised. (See Page 126.)
- **Front Horn** – Check for proper function. (See Page 48.)
- **Operator Cab** – Check the fastening bolts, washers, and nuts. Check the condition of the cab. (See Page 133.)
- **Indicators and Lights** – Check for correct operation of all indicators and lights. (See Page 38.)
- **Safety Signs and Safety Treads** – Check for damaged signs (decals) and safety treads. Replace any signs or safety treads that are damaged or worn. (See Page 19.) and (See Page 91.)
- **Hydraulic Fluid** – Check fluid level and add as needed. (See Page 165.)
- **Heater and Air Conditioning Filters** (if equipped) – Clean or replace filters as needed. (See Page 138.)



## SERVICE SCHEDULE (CONT'D)

### Maintenance Intervals (Cont'd)

#### *Every 50 Hours*

- **Hydraulic Hoses and Tubelines** – Check for damage and leaks. Repair or replace as needed.
- **Parking Brake and Joysticks** – Check for correct operation. Repair or adjust as needed.
- **Track Drive Sprocket Nuts** – Check for loose sprocket nuts and tighten to correct torque. (See Page 174.)
- **Track Tension** – Check tension and adjust as needed. (See Page 171.)
- **Engine / Hydrostatic Drive Belt** – Perform at first 50 hours, then as scheduled. Check for wear or damage. Adjust or replace as needed. (See Page 178.)
- **Engine Oil and Filter** – Perform at first 50 hours, then as scheduled. Replace oil and filter. (See Page 149.)

#### *Every 100 Hours*

- **Battery** – Check cables, connections, and electrolyte level; add distilled water as needed. (See Page 162.)
- **Engine Oil and Filter** – Perform every 100 hours when operating under severe conditions. Replace oil and filter. (See Page 149.)

#### *Every 250 Hours or Every 12 Months*

- **Engine / Hydrostatic Drive Belt** – Check for wear or damage. Adjust or replace as needed. (See Page 178.)
- **Drive Belts (Alternator, air conditioning, water pump)** – Check condition. Replace as needed. (See Page 175.) and (See Page 176.)
- **Bobcat Interlock Control System (BICS™)** – Check the function of the lift arm bypass control. (See Page 126.)

#### *Every 500 Hours or Every 12 Months*

- **Fuel Filter** – Replace filter element. (See Page 145.)
- **Hydraulic Charge Filter, Hydraulic Reservoir Breather Cap** – Replace the charge filter and the reservoir breather cap. (See Page 169.) and (See Page 170.)
- **Hydrostatic Motor Carrier** – Replace oil with high performance synthetic oil. (See Page 174.)
- **Engine Oil and Filter** – Replace oil and filter. (See Page 149.)
- **Heater Coil and Air Conditioning Evaporator** (if equipped) - Clean the heater coil and air conditioning evaporator. Clean the plenum drains. (See Page 139.)

#### *Every 1000 Hours or Every 12 Months*

- **Hydraulic / Hydrostatic Filter** – Replace the hydraulic / hydrostatic filter. (See Page 168.)
- **Hydraulic Reservoir** – Replace the fluid. (See Page 166.)
- **Engine Valves** – Adjust the engine valve clearance.

#### *Every 1500 Hours or Every 24 Months*

- **Coolant** – Replace the coolant. (See Page 155.)

#### *Every 3000 Hours or Every 36 Months*

- **Diesel Exhaust Fluid (DEF) / AdBlue® Filter** – Replace the diesel exhaust fluid (DEF) / AdBlue® filter.

**NOTE: The Inspection Checkbook can be ordered for you by your local dealer. Part number 7296478.**



## SERVICE SCHEDULE (CONT'D)

### Inspection Checkbook

Maintenance work must be done at regular intervals. Failure to do so will result in excessive wear and early failures.

The service schedule is a guide for correct maintenance of the Bobcat loader.

The Inspection Checkbook contains the following information:

- Doosan Bobcat EMEA s.r.o. Warranty Policy
- Doosan Bobcat EMEA s.r.o. Extended Warranty Policy

The Inspection Checkbook has to be filled in by the Dealer for any maintenance and service work of your Bobcat machine. This book may be required anytime by an authorised dealer or by Bobcat Europe, should a breakdown occur on the Bobcat equipment.

Your local dealer can order the Inspection Checkbook. Part number: 7296478.

## BOBCAT INTERLOCK CONTROL SYSTEM (BICS™)

See the SERVICE SCHEDULE for the correct service interval. (See SERVICE SCHEDULE on Page 123.)

### Inspecting The BICS™ (Engine STOPPED – Key ON)

Figure 157

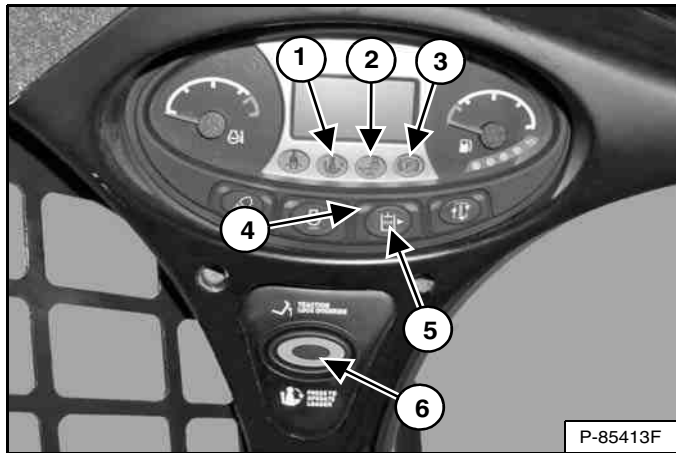

1. Sit in operator's seat. Turn key switch to RUN. Lower seat bar and disengage parking brake. Press the PRESS TO OPERATE LOADER button (Item 6). Two BICS™ lights (Items 1 and 2) [Figure 157] [SEAT BAR and LIFT AND TILT VALVE] on left instrument panel must be OFF. The PRESS TO OPERATE LOADER button will light.
2. Raise seat bar fully. All three BICS™ lights (Items 1, 2, and 3) [Figure 157] [SEAT BAR, LIFT AND TILT VALVE, and PARKING BRAKE] on left instrument panel must be ON. The PRESS TO OPERATE LOADER button light will turn OFF.

### Inspecting Deactivation Of The Auxiliary Hydraulics System (Engine STOPPED – Key ON)

3. Sit in operator's seat, lower seat bar, and press the PRESS TO OPERATE LOADER button (Item 6). Press the Auxiliary Hydraulics button (Item 5). The auxiliary hydraulics light will turn ON (Item 4) [Figure 157]. Raise the seat bar. The light will turn OFF.

### Inspecting The Seat Bar Sensor (Engine RUNNING)

4. Sit in operator's seat, lower seat bar, engage parking brake, and fasten seat belt.
5. Start engine and operate at low idle. Press the PRESS TO OPERATE LOADER button. While raising the lift arms, raise the seat bar fully. The lift arms must stop. Repeat using the tilt function.

### Inspecting The Traction Lock And Parking Brake (Engine RUNNING)

6. Fasten seat belt, disengage parking brake, press the PRESS TO OPERATE LOADER button, and raise seat bar fully. Move joystick(s) slowly forward and backward. The TRACTION lock must be engaged. Lower the seat bar. Press the PRESS TO OPERATE LOADER button.
7. Engage parking brake and move joystick(s) slowly forward and backward. The TRACTION lock must be engaged. See your Bobcat dealer for service if loader fails to stop.

**NOTE:** The PARKING BRAKE light on the left instrument panel will remain ON until the engine is started, the PRESS TO OPERATE LOADER button is pressed, and the parking brake is disengaged.

### Inspecting The Lift Arm Bypass Control

8. Raise the lift arms 2 m (6 ft) off the ground. Stop engine. Turn lift arm bypass control knob 90° clockwise. Pull up and hold lift arm bypass control knob until lift arms slowly lower.

### Inspecting Deactivation Of Lift And Tilt Functions

9. Sit in operator's seat and fasten seat belt. Lower seat bar, start engine, and press the PRESS TO OPERATE LOADER button.
10. Raise lift arms approximately 2 m (6 ft) off the ground.
11. Turn key switch to STOP and wait for the engine to come to a complete stop.
12. Turn key switch to RUN. Press the PRESS TO OPERATE LOADER button, move the joystick to lower the lift arms. Lift arms must not lower.
13. Move the control joystick to tilt the bucket (or attachment) forward. The bucket (or attachment) must not tilt forward.

## WARNING

### AVOID INJURY OR DEATH

The Bobcat Interlock Control System (BICS™) must deactivate the lift, tilt and traction drive functions. If it does not, contact your dealer for service. DO NOT modify the system.

W-2151-1111



## SEAT BAR RESTRAINT SYSTEM

### Description

**Figure 158**

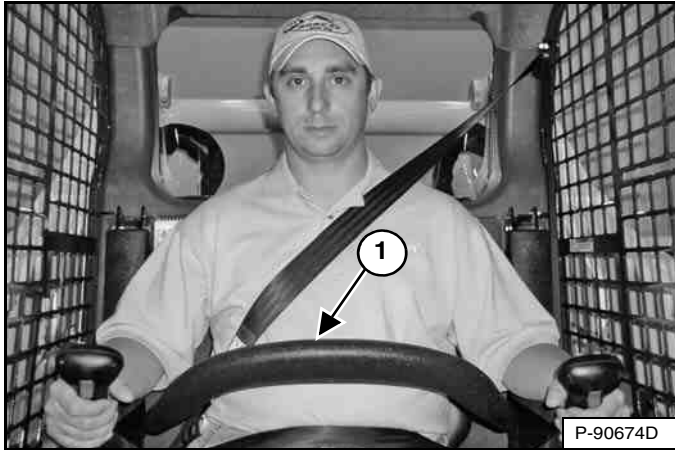

The seat bar restraint system has a pivoting seat bar with armrests (Item 1) [Figure 158].

The operator controls the use of the seat bar. The seat bar in the down position helps to keep the operator in the seat.

When the seat bar is down, the engine is running, the PRESS TO OPERATE LOADER button is activated, and the brake is released; the lift, tilt, and traction drive functions can be operated.

When the seat bar is up, the lift and tilt functions are deactivated even though the joysticks do not mechanically lock.

### Inspection And Maintenance

See the SERVICE SCHEDULE for the correct service interval. (See SERVICE SCHEDULE on Page 123.)

Sit in the seat and fasten the seat belt. Engage the parking brake. Pull the seat bar all the way down. Start the engine. Press the PRESS TO OPERATE LOADER button.

Operate the hydraulic controls to check that the lift and tilt functions operate correctly. Raise the lift arms until the attachment is approximately 600 mm (2 ft) off the ground.

Raise the seat bar. Move the joysticks. There must be no motion of the lift arms or tilt (attachment) when the controls are moved.

Lower the seat bar, press the PRESS TO OPERATE LOADER button, and lower the lift arms. Operate the lift control. While the lift arms are going up, raise the seat bar. The lift arms must stop.

Lower the seat bar, press the PRESS TO OPERATE LOADER button, lower the lift arms, and put the attachment flat on the ground. Stop the engine.

**Figure 159**

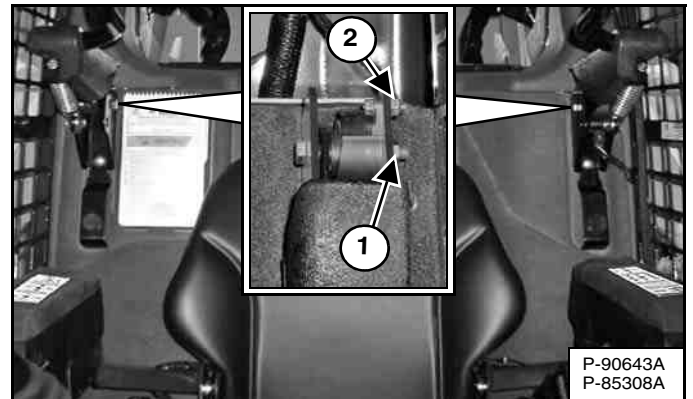

Use compressed air to clean any debris or dirt from the pivot parts. Do not lubricate. Inspect all mounting hardware. The correct hinge nut (both sides) (Item 1) torque is 34 – 38 N•m (25 – 28 ft-lb). The seat bar sensor nut (left side only) (Item 2) [Figure 159] torque is 6 – 8 N•m (50 – 70 in-lb).

If the seat bar system does not function correctly, replace parts that are worn or damaged. Use only genuine Bobcat replacement parts.

## **WARNING**

**The seat bar system must deactivate the lift and tilt control functions when the seat bar is up. See your Bobcat dealer for service if hydraulic controls do not deactivate.**

W-2465-0111

## SEAT BELT

### Inspection And Maintenance

# ! WARNING

Failure to properly inspect and maintain the seat belt can cause lack of operator restraint resulting in serious injury or death.

W-2466-0703

Check the seat belt daily for correct function.

Inspect the seat belt system thoroughly at least once each year, or more often if the machine is exposed to severe environmental conditions or applications.

Any seat belt system that shows cuts, fraying, extreme or unusual wear, significant discolourations due to ultraviolet UV exposure, dusty / dirty conditions, abrasion to the seat belt webbing, or damage to the buckle, latch plate, retractor (if equipped), hardware, or any other obvious problem should be replaced immediately.

The items below are referenced in [Figure 160].

1. Check the webbing. If the system is equipped with a retractor, pull the webbing completely out and inspect the full length of the webbing. Look for cuts, wear, fraying, dirt, and stiffness.
2. Check the buckle and latch for correct operation. Make sure latch plate is not excessively worn or deformed and buckle is not damaged or casing broken.
3. Check the retractor web storage device (if equipped) by extending webbing to determine if it looks correct, and that it spools out and retracts webbing correctly.
4. Check webbing in areas exposed to ultraviolet (UV) rays from the sun, or extreme dust or dirt. If the original colour of the webbing in these areas is extremely faded and / or the webbing is packed with dirt, the webbing strength may have deteriorated.
5. Check the hardware on both sides of the seat. Hardware should be tight. Hardware must not be missing, rusted, corroded, or damaged.

See your Bobcat dealer for seat belt system replacement parts for your machine.

Figure 160

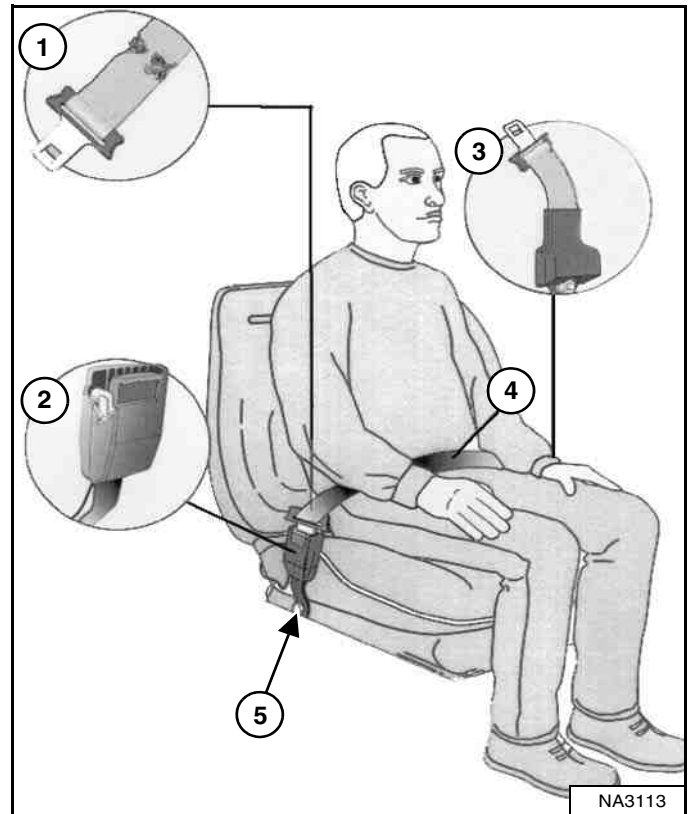

## LIFT ARM SUPPORT DEVICE

### Description



Never work on a machine with the lift arms up unless the lift arms are secured by an approved lift arm support device. Failure to use an approved lift arm support device can allow the lift arms or attachment to fall and cause injury or death.

Service lift arm support device if damaged or if parts are missing. Using a damaged lift arm support or with missing parts can cause lift arms to drop causing injury or death.

W-2572-0407

Figure 161

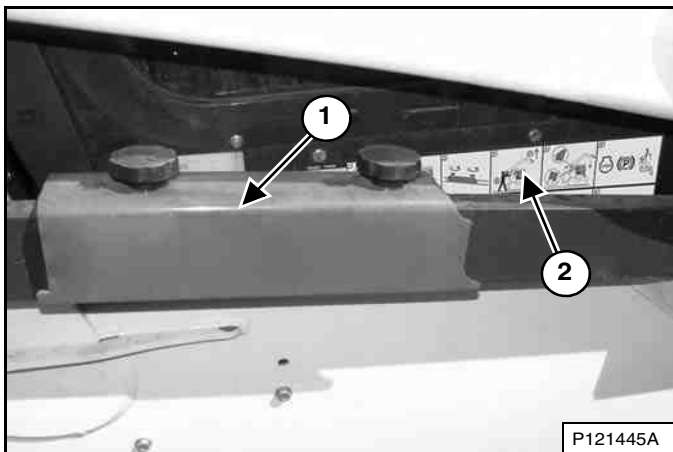

The lift arm support device (Item 1) [Figure 161] is used to support the lift arms while working on a machine with the lift arms up.

A decal (Item 2) [Figure 161] located on the right side of the operator cab provides instructions for installing and removing the lift arm support device.

The procedures are described in more detail on the following pages. (See Installing on Page 130.) and (See Removing on Page 131.)

LIFT ARM SUPPORT DEVICE (CONT'D)

Installing



P-90328

**AVOID DEATH**

- Disconnecting or loosening any hydraulic tubeline, hose, fitting, component or a part failure can cause lift arms to drop.
- Keep out of this area when lift arms are raised unless supported by an approved lift arm support. Replace if damaged.

D-1009-0409

Remove attachment from the loader. (See Installing And Removing The Attachment (Hand Lever Bob-Tach) on Page 106.) **OR** (See Installing And Removing The Attachment (Power Bob-Tach) on Page 109.)

Figure 162

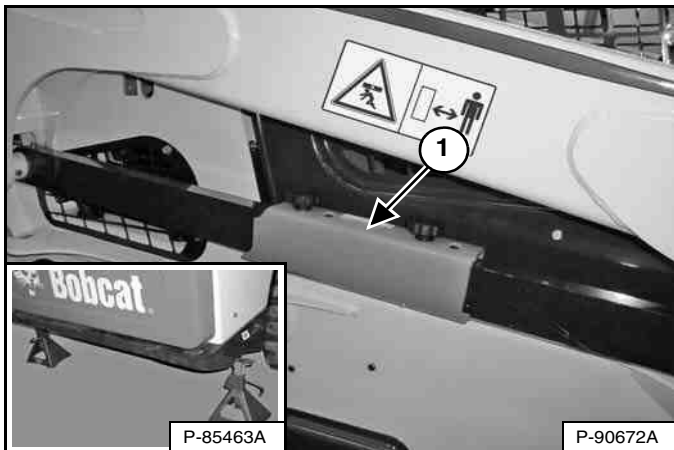

Put jackstands under the rear corners of the loader frame (Inset) [Figure 162].

Remove the lift arm support device (Item 1) [Figure 162] from the storage position.

The operator must stay in the operator seat with the seat belt fastened and the seat bar lowered until the lift arm support device is installed.

Start the engine and raise the lift arms all the way up.

Figure 163



Have a second person install the lift arm support device over the rod of one of the lift cylinders [Figure 163].

The lift arm support device must be tight against the cylinder rod.

Figure 164

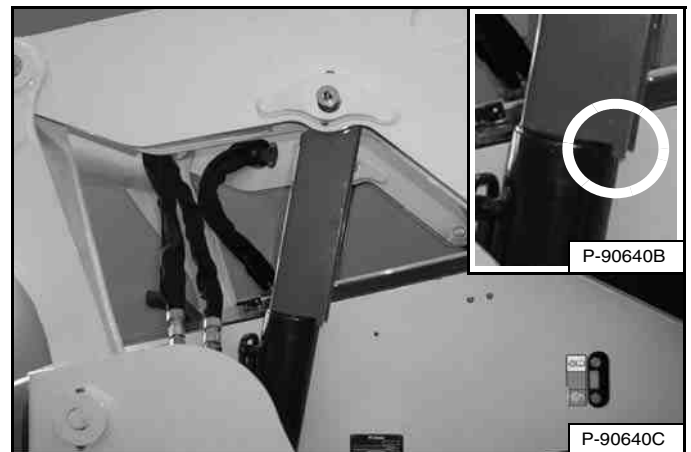

Lower the lift arms slowly until the lift arm support device is held between the lift arms and the lift cylinder. The tabs of the lift arm support device must go past the end of the cylinder (Inset) [Figure 164].

LIFT ARM SUPPORT DEVICE (CONT'D)

Removing

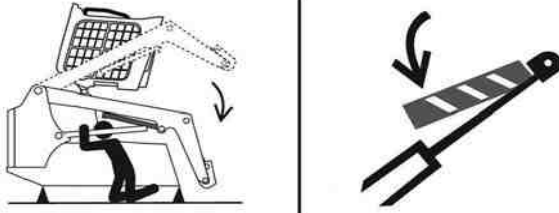

P-90328

**AVOID DEATH**

- **Disconnecting or loosening any hydraulic tubeline, hose, fitting, component or a part failure can cause lift arms to drop.**
- **Keep out of this area when lift arms are raised unless supported by an approved lift arm support. Replace if damaged.**

D-1009-0409

The operator must stay in the operator seat with the seat belt fastened and the seat bar lowered until the lift arm support device is removed and the lift arms are lowered all the way.

Start the engine and raise the lift arms all the way up.

**Figure 165**



Have a second person remove the lift arm support device [Figure 165].

Lower the lift arms all the way and stop the engine.

**Figure 166**



Return the lift arm support device to the storage position and secure with the clamping knobs [Figure 166].

Remove the jackstands.

## BACK-UP ALARM SYSTEM

This machine may be equipped with a back-up alarm.

### Description

The back-up alarm will sound when the operator moves the joystick(s) into the reverse position. Slight movement of the controls into the reverse position is required with hydrostatic transmissions, before the back-up alarm will sound.

### Inspection

See the SERVICE SCHEDULE for the correct service interval. (See SERVICE SCHEDULE on Page 123.)

#### Figure 167

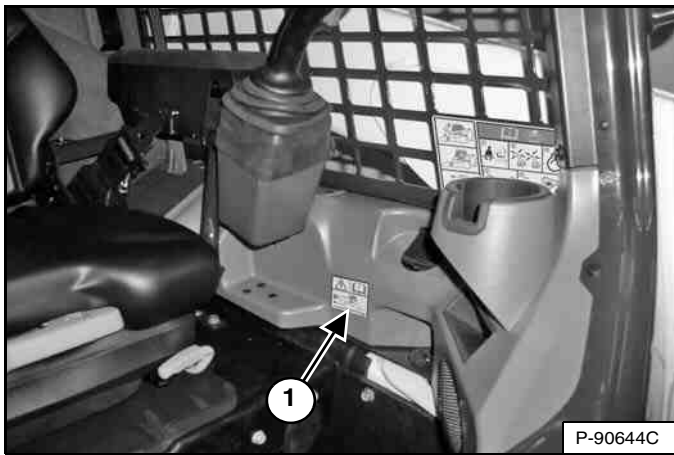

Inspect for damaged or missing back-up alarm decal (Item 1) [Figure 167]. Replace if required.

Sit in the seat and fasten the seat belt. Engage the parking brake. Pull the seat bar all the way down. Start the engine. Press the PRESS TO OPERATE LOADER button. Disengage the parking brake.

Move the joystick(s) into the reverse position. The back-up alarm must sound when both tracks are moving in reverse.

The back-up alarm is located on the inside of the rear door.

#### Figure 168

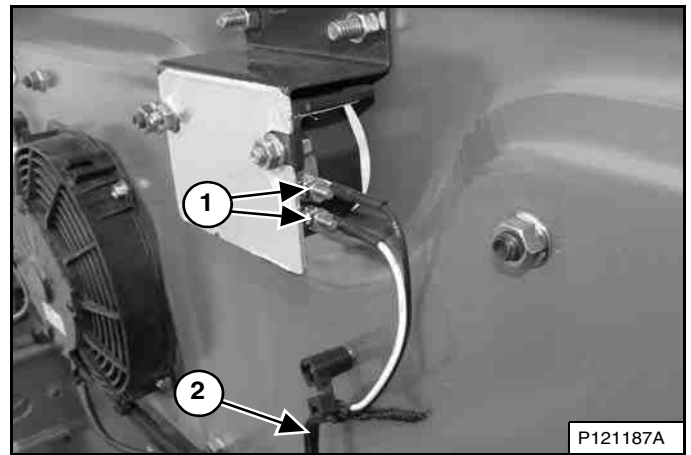

Inspect the back-up alarm electrical connections (Item 1) and wire harness (Item 2) [Figure 168] for tightness and damage. Repair or replace any damaged components.

**NOTE: See your Bobcat dealer for service if your back-up alarm does not sound.**

## OPERATOR CAB

### Description

The Bobcat loader has an operator cab (ROPS and FOPS) as standard equipment to protect the operator from rollover and falling objects. The seat belt must be worn for rollover protection.

Check the cab, mounting, and hardware for damage. Never modify the cab. Replace the cab and hardware if damaged. See your Bobcat dealer for parts.

ROPS – Roll-Over Protective Structure per ISO 3471 and FOPS – Falling-Object Protective Structure per ISO 3449, Level I. Level II is available.

#### Level I

Protection from falling bricks, small concrete blocks, and hand tools encountered in operations, such as: motorway maintenance, landscaping, and other construction sites.

#### Level II

Protection from falling trees, rocks: for machines involved in site clearing, overhead demolition, or forestry.



Never modify operator cab by welding, grinding, drilling holes or adding attachments unless instructed to do so by Bobcat Company. Changes to the cab can cause loss of operator protection from rollover and falling objects, and result in injury or death.

W-2069-0200

### Cab Door Sensor

This machine may be equipped with a Cab Door Sensor.

**Figure 169**

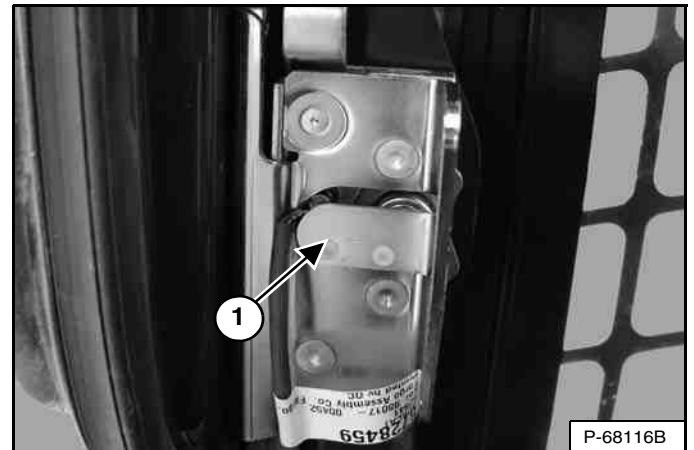

The cab door has a sensor (Item 1) [Figure 169] installed that deactivates the lift and tilt valves when the door is open.

**Figure 170**



The LIFT AND TILT VALVE light (Item 1) [Figure 170] is OFF when the door is closed, the key switch is turned to RUN, the seat bar is lowered, and the PRESS TO OPERATE LOADER button is pressed.

The LIFT AND TILT VALVE light (Item 1) [Figure 170] is ON when the door is open, the key switch is turned to RUN, the seat bar is lowered, and the PRESS TO OPERATE LOADER button is pressed.

[DOOR] will appear in the data display (Item 2) [Figure 170] when the door is open, the key switch is turned to RUN, the seat bar is lowered, and the PRESS TO OPERATE LOADER button is pressed.

## OPERATOR CAB (CONT'D)

### Raising

Always stop the engine before raising or lowering the operator cab.

Stop the loader on a level surface. Lower the lift arms. If the lift arms must be up while raising the operator cab, install the lift arm support device. (See LIFT ARM SUPPORT DEVICE on Page 129.)

**Figure 171**

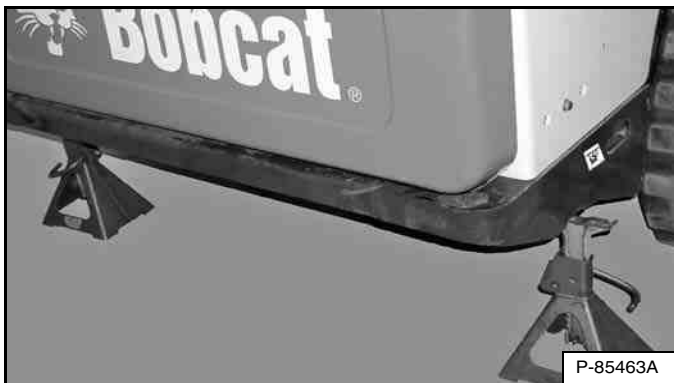

Install jackstands under the rear of the loader frame [Figure 171].

**Figure 172**

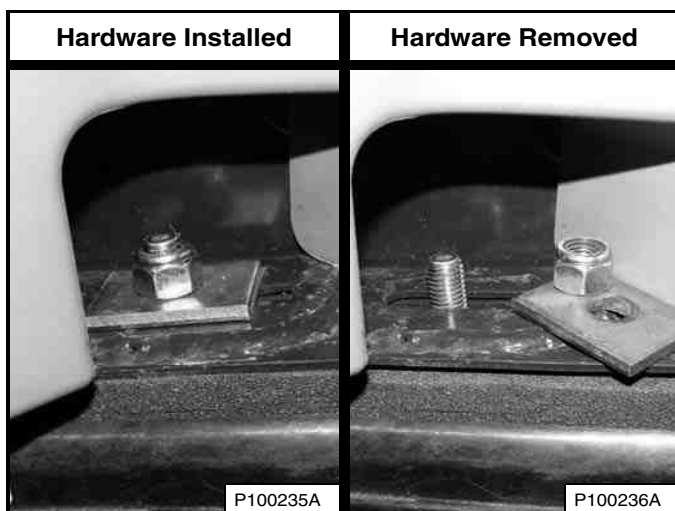

Remove the nuts and washers [Figure 172] (both sides) at the front corners of the operator cab.

**Figure 173**



Lift on the grab handles and bottom of the operator cab [Figure 173] slowly until the operator cab is all the way up and the latching mechanism engages.



## OPERATOR CAB (CONT'D)

### Lowering

Always stop the engine before raising or lowering the operator cab.

**NOTE:** Always use the grab handles to lower the operator cab.

Figure 174



Pull down on the bottom of the operator cab until stopped by the latching mechanism [Figure 174].

**NOTE:** The weight of the operator cab increases when equipped with options and accessories, such as: cab door, heater, and air conditioning. In these cases, the operator cab may need to be raised slightly from the latch to be able to release the latch.

Support the operator cab and release the latching mechanism (Inset) [Figure 174]. Remove your hand from the latch mechanism when the operator cab is past the latch stop. Use both hands to lower the operator cab all the way down.

# ! WARNING

**PINCH POINT CAN CAUSE INJURY**

Remove your hand from the latching mechanism when the cab is past the latch stop.

W-2469-0803

Figure 175

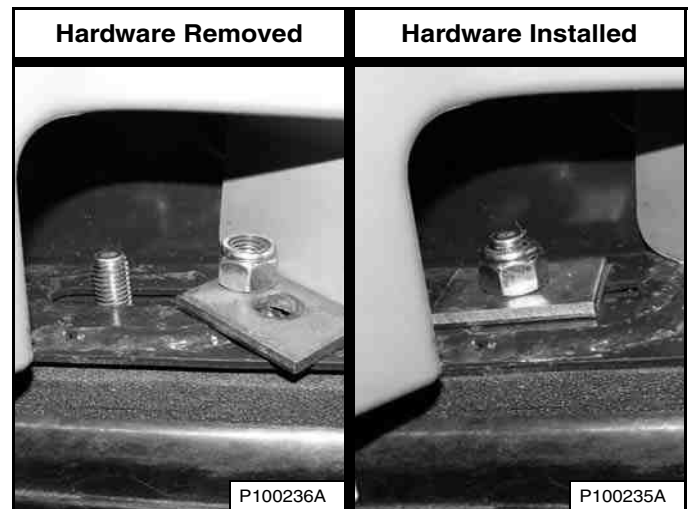

Install the washers and nuts (both sides) [Figure 175].

Tighten the nuts to 54 – 61 N•m (40 – 45 ft-lb) torque.

Remove the jackstands.

## REAR DOOR (TAILGATE)

### Opening And Closing

Figure 176

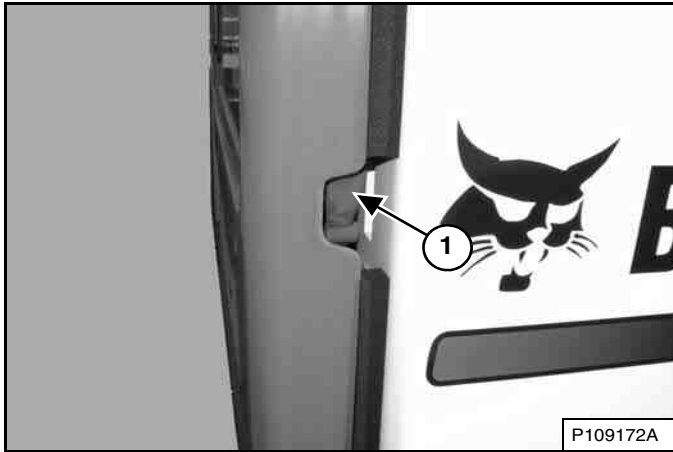

Reach into the slot on the right side of the rear door and pull the latch handle (Item 1) [Figure 176]. Pull the rear door open.

The rear door is equipped with a door stop feature on the top hinge.

Figure 177

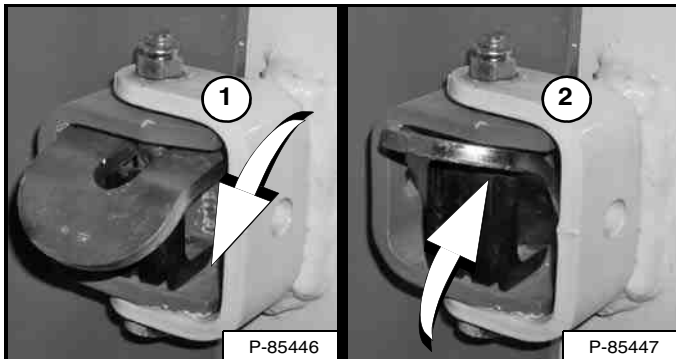

Move the door stop into the engaged position (Item 1) to hold the door open. Move the door stop up (Item 2) [Figure 177] to allow the door to close.

## **WARNING**

Keep the rear door closed when operating the machine. Failure to do so could seriously injure a bystander.

W-2020-1285

Close the rear door.

### Adjusting Latch

Figure 178

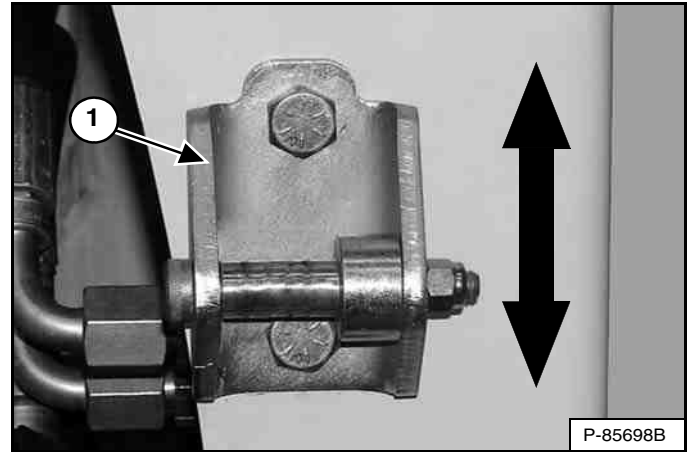

The door latch striker (Item 1) [Figure 178] can be adjusted up or down for alignment with the door latch.

Close the rear door before operating the loader.

## REAR GRILLE

### Removing

Stop the engine.

**Figure 179**

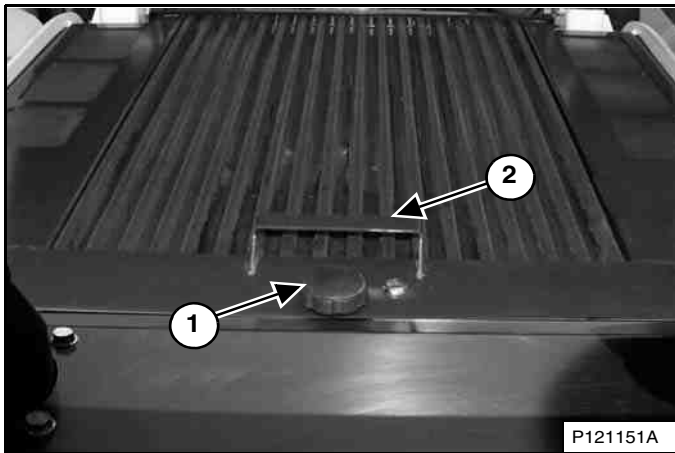

Remove the clamping knob (Item 1). Lift using the handle (Item 2) [Figure 179] and pull the rear grille backward to remove from the loader.

**Figure 180**

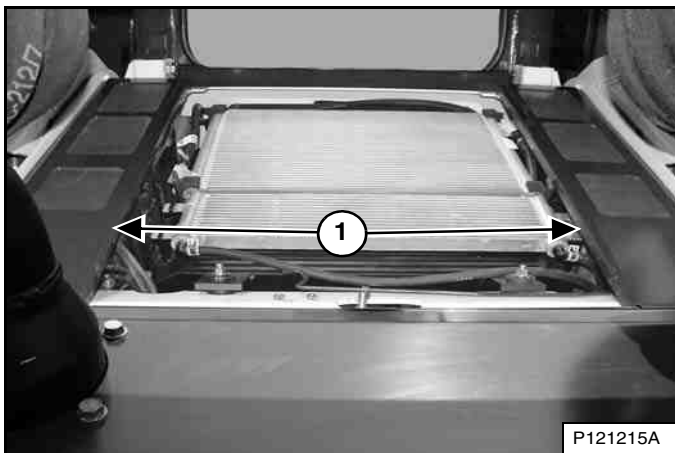

Lift and remove the two side covers (Item 1) [Figure 180].

### Installing

**Figure 181**



Insert the front tab of the two side covers into the slots in the loader frame and lower [Figure 181]. (Left side shown.)

**Figure 182**

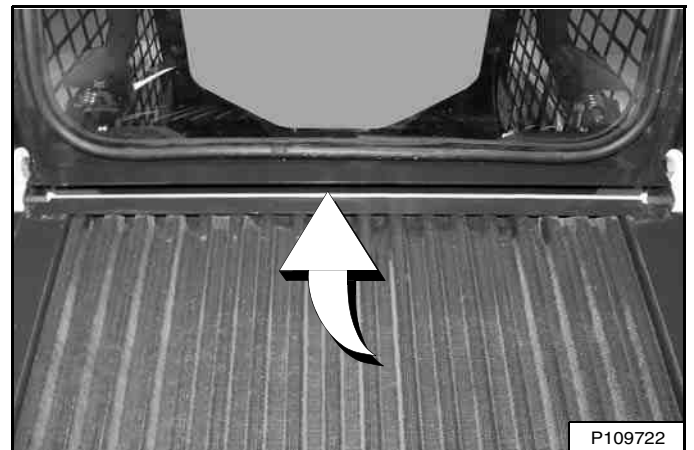

Insert the edge of the rear grille under the loader frame and slide rear grille in while lowering [Figure 182].

Install the clamping knob (Item 1) [Figure 179].

## HEATING, VENTILATION, AND AIR CONDITIONING (HVAC) SYSTEM

This machine may be equipped with a cab heater or HVAC system.

### Filters

See the SERVICE SCHEDULE for the correct service interval. (See SERVICE SCHEDULE on Page 123.)

#### Fresh Air Filters

**Figure 183**

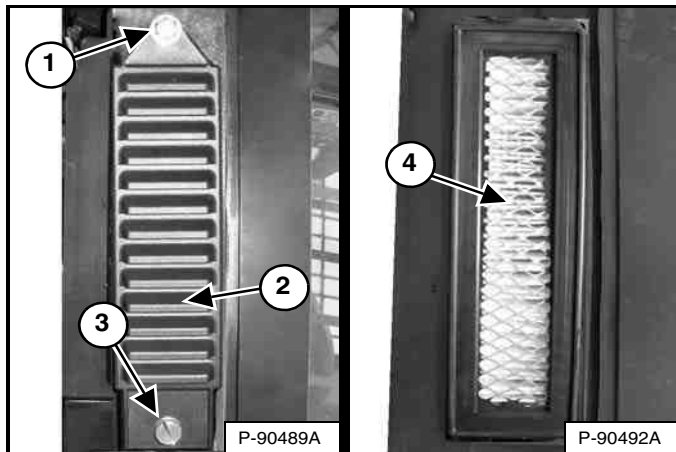

The fresh air filters are located behind the side windows outside the operator cab. (Right side shown) Remove the retaining screw (Item 3) and the filter cover (Item 2) [Figure 183]. (Lift arms shown raised for visual clarity.)

**NOTE: Loosen the upper filter cover bolt (Item 1) [Figure 183] to allow removal and installation of the cover if equipped with the High-Efficiency Particulate Air (HEPA) filter kit.**

Shake the filter (Item 4) [Figure 183] or use low pressure air to remove dirt. This procedure can be done several times before replacement is required. Install the filter, the filter cover, and the retaining screw.

#### Recirculation Filter

**Figure 184**

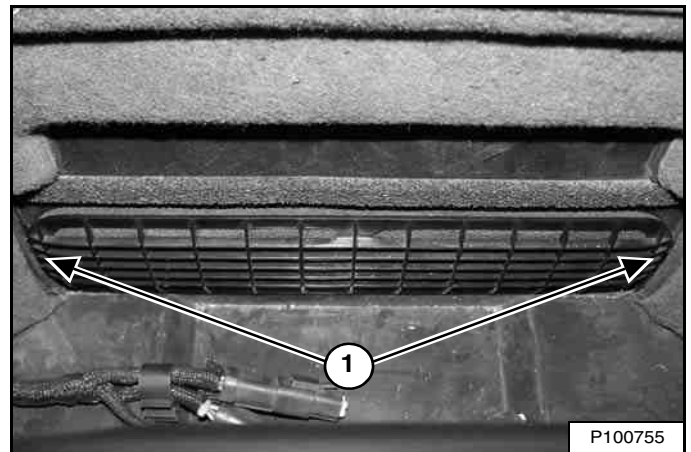

The recirculation filter is located behind the operator's seat inside the operator cab. The filter cover is held in position with three clips. Pull the cover at each end (Item 1) [Figure 184] to remove.

Rinse the filter with water or use a vacuum cleaner to clean. Do not use solvents.

Line up the clips on the filter cover with the slots provided and push the cover into position.

## HEATING, VENTILATION, AND AIR CONDITIONING (HVAC) SYSTEM (CONT'D)

### Air Conditioning Evaporator / Heater Coil

See the SERVICE SCHEDULE for the correct service interval. (See SERVICE SCHEDULE on Page 123.)

Stop the engine and raise the operator cab. (See Raising on Page 134.)

**Figure 185**

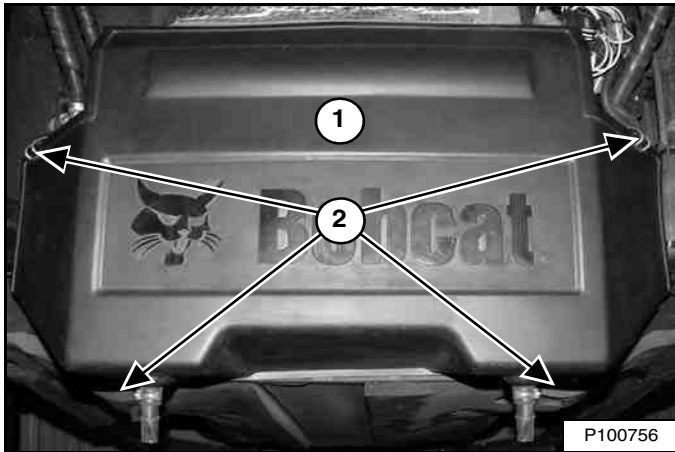

Unhook the cover latches (Item 2) and remove the cover (Item 1) [Figure 185].

**Figure 186**

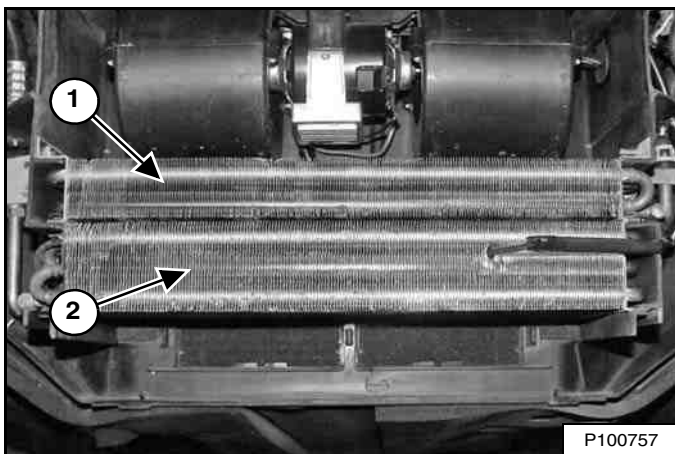

Use low pressure air or water to remove debris from the heater coil (Item 1) and evaporator (Item 2) [Figure 186].

**Figure 187**

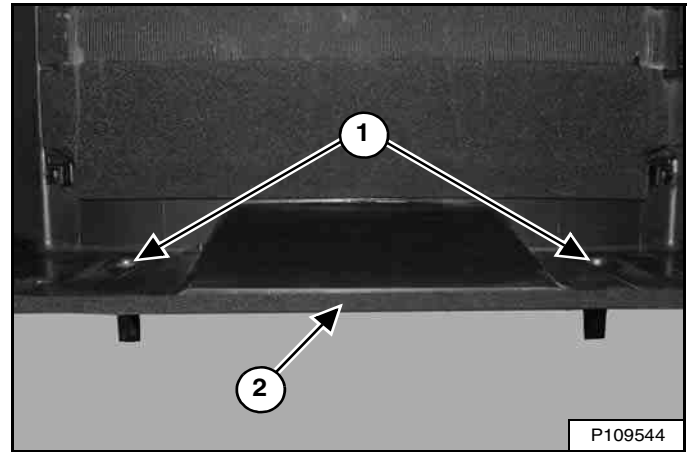

Clean the plenum drains (Item 1) [Figure 187] to ensure they are not plugged by debris.

Inspect the cover seal (Item 2) [Figure 187] for breaks and tears. Ensure the seal is firmly attached all around the cover. See your Bobcat dealer for a replacement seal.

**Figure 188**

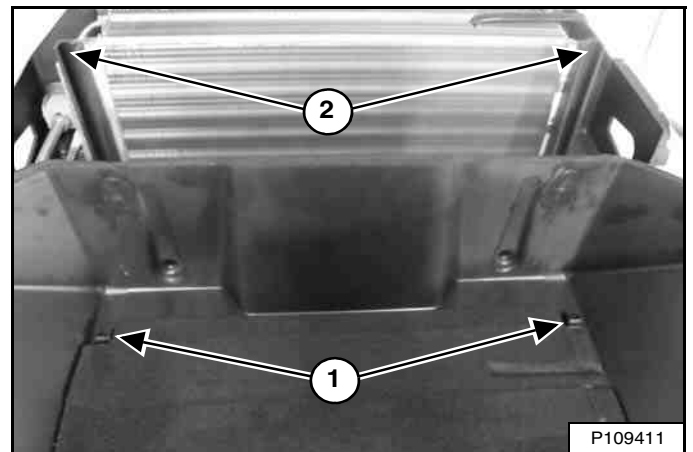

**NOTE:** The bosses (Item 1) fit inside the core supports (Item 2) [Figure 188] when the cover is installed. Deformity of the cover indicates they are out of position.

## HEATING, VENTILATION, AND AIR CONDITIONING (HVAC) SYSTEM (CONT'D)

### Air Conditioning Evaporator / Heater Coil (Cont'd)

**NOTE:** Improper cover installation can damage the seal, which may lead to HVAC component failure. Perform the following steps in the order given to prevent cover seal damage.

Figure 189

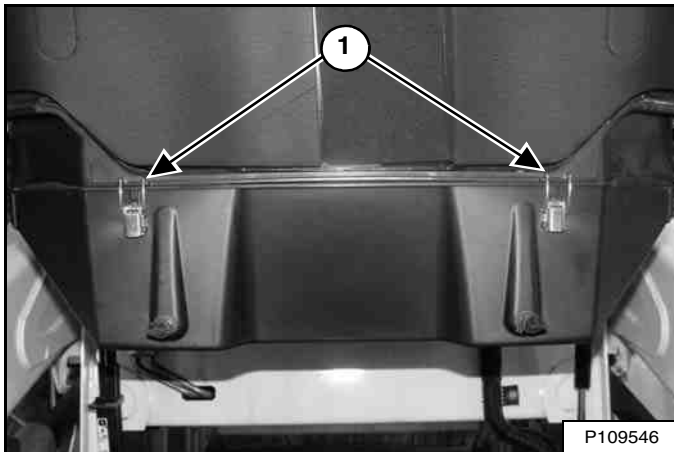

1. Hold the cover in place and fasten two latches (Item 1) [Figure 189].

Figure 190



2. Push the cover up in three places (Items 1, 2, and 3) until the slots snap into place on the tabs. This slot (Inset) [Figure 190] is correctly fastened.

Figure 191

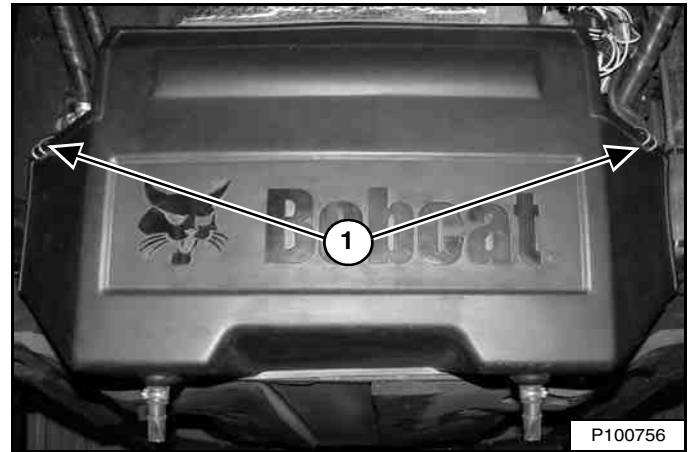

3. Fasten the two remaining latches (Item 1) [Figure 191].

**NOTE:** Perform a thorough visual check to ensure that the cover and the cover seal are not deformed. The cover should seal tightly all around without any gaps.

Lower the operator cab. (See Lowering on Page 135.)

### Air Conditioning Condenser

The condenser should be cleaned with the hydraulic fluid cooler and radiator assembly. (See Cleaning on Page 151.)

### Air Conditioning Lubrication

Operate the air conditioning for approximately 5 minutes every week to lubricate the internal components.

### Troubleshooting

If the fan does not operate or the air conditioning does not turn on, check the fuse. (See Fuse And Relay Location / Identification on Page 157.) The refrigerant may need to be recharged if the air conditioning system circulates warm air.

## ENGINE AIR CLEANER

### Replacing Filters

Figure 192



Replace the air filters only when necessary. The service indicator (Item 1) will FLASH. Press the Information button (Item 3) until the display screen shows the service codes. Service code [M0117] (Air Filter Plugged) will show in the display screen (Item 2) [Figure 192] when air filter replacement is necessary.

Replace the inner filter every second time the outer filter is replaced or as indicated.

#### Outer Filter

Stop the engine and remove the rear grille. (See REAR GRILLE on Page 137.)

Figure 193

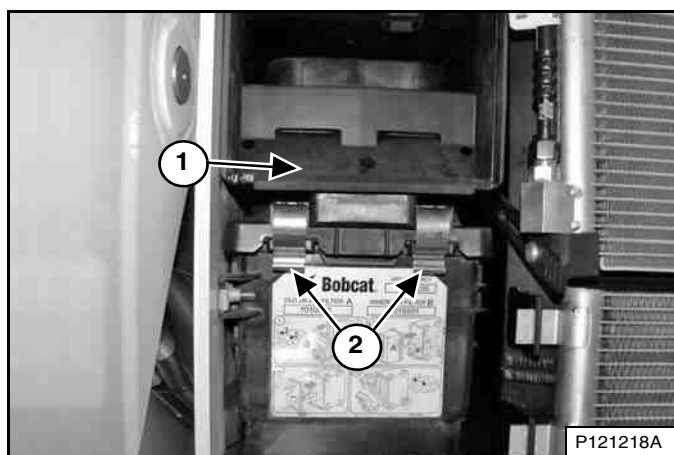

Open the latches (Item 2) and remove the cover (Item 1) [Figure 193].

Figure 194

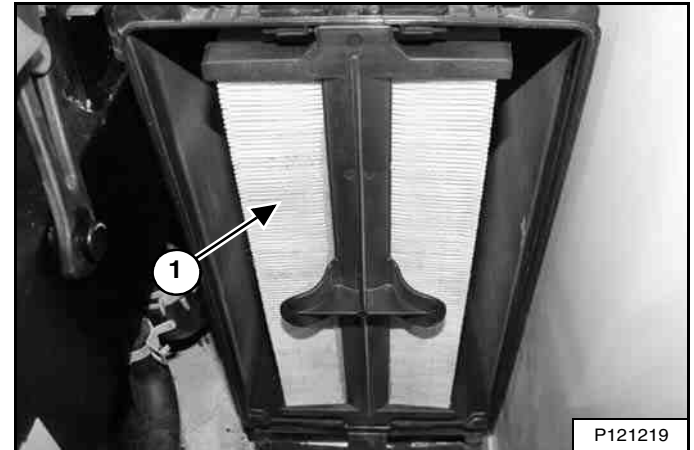

Remove the outer filter (Item 1) [Figure 194] and discard.

**NOTE: Make sure the filter housing is free of dirt and debris. Verify that sealing surfaces are clean. DO NOT use compressed air.**

Install new outer filter. Push in until the filter contacts the base of the housing.

Install the cover and secure the latches [Figure 193].

**NOTE: The rubber boot attached to the air cleaner cover is an important part of the engine cooling system and must remain correctly installed on the air cleaner cover.**

Install the rear grille.

## ENGINE AIR CLEANER (CONT'D)

### Replacing Filters (Cont'd)

#### Inner Filter

Replace the inner filter only under the following conditions:

- Replace the inner filter every *second* time the outer filter is replaced.
- After the outer filter has been replaced, start the engine and operate at full rpm. If service code **[M0117]** (Air Filter Plugged) is still displayed in the data display, replace the inner filter.

Stop the engine and remove the rear grille. (See REAR GRILLE on Page 137.)

Remove the cover **[Figure 193]** and the outer filter **[Figure 194]**.

**Figure 195**

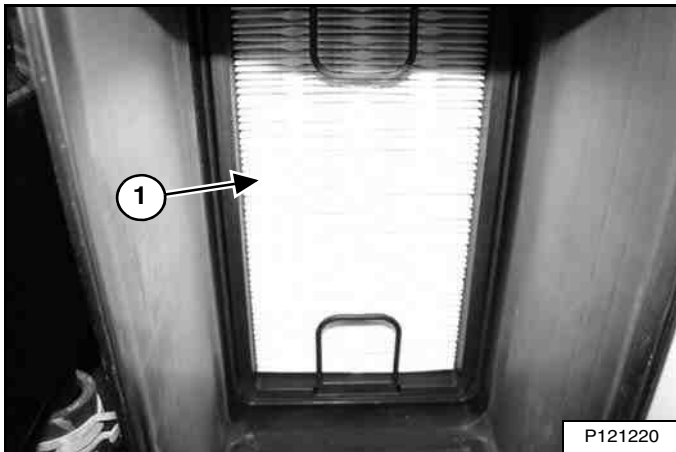

Remove the inner filter (Item 1) **[Figure 195]**.

**NOTE:** Make sure the filter housing is free of dirt and debris. Verify that sealing surfaces are clean. **DO NOT** use compressed air.

Install new inner filter. Push in until the filter contacts the base of the housing.

Install the outer filter **[Figure 194]**.

**Figure 196**

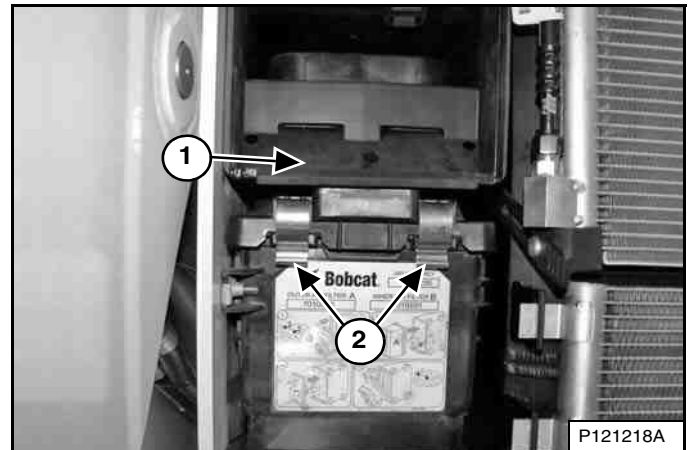

Install the cover (Item 1) and secure the latches (Item 2) **[Figure 196]**.

**NOTE:** The rubber boot attached to the air cleaner cover is an important part of the engine cooling system and must remain correctly installed on the air cleaner cover.

Install the rear grille.





**FUEL SYSTEM**

**Fuel Specifications**

**NOTE: Contact your local fuel supplier to receive recommendations for your region.**

*U.S. Standard (ASTM D975)*

Use only clean, high quality diesel fuel, Grade Number 2-D or Grade Number 1-D.

Ultra low sulfur diesel fuel must be used in this machine. Ultra low sulfur is defined as 15 mg/kg (15 ppm) sulfur maximum.

The following is one suggested blending guideline that should prevent fuel gelling during cold temperatures:

TEMPERATURE	GRADE 2-D	GRADE 1-D
Above -9°C (+15°F)	100%	0%
Down to -21°C (-5°F)	50%	50%
Below -21°C (-5°F)	0%	100%

**NOTE: Biodiesel blend fuel may also be used in this machine. Biodiesel blend fuel must contain no more than five percent biodiesel mixed with ultra low sulfur petroleum based diesel. This biodiesel blend fuel is commonly marketed as B5 blended diesel fuel. B5 blended diesel fuel must meet ASTM specifications.**

*E.U. Standard (EN590)*

Use only clean, high quality diesel fuel that meets the EN590 specifications listed below:

- Ultra low sulfur diesel fuel defined as 10 mg/kg (10 ppm) sulfur maximum
- Diesel fuel with cetane number of 51.0 and above.

**NOTE: Biodiesel blend fuel may also be used in this machine. Biodiesel blend fuel must contain no more than seven percent biodiesel mixed with ultra low sulfur petroleum based diesel. This biodiesel blend fuel is commonly marketed as B7 blended diesel fuel. B7 blended diesel fuel must meet EN590 specifications.**

**Biodiesel Blend Fuel**

Biodiesel blend fuel has unique qualities that should be considered before using in this machine:

- Cold weather conditions can lead to plugged fuel system components and hard starting.
- Biodiesel blend fuel is an excellent medium for microbial growth and contamination that can cause corrosion and plugging of fuel system components.
- Use of biodiesel blend fuel may result in premature failure of fuel system components, such as: plugged fuel filters and deteriorated fuel lines.
- Shorter maintenance intervals may be required, such as: cleaning the fuel system and replacing fuel filters and fuel lines.
- Using biodiesel blended fuels containing more than five percent biodiesel can affect engine life and cause deterioration of hoses, tubelines, injectors, injector pump, and seals.

Apply the following guidelines if biodiesel blend fuel is used:

- Ensure the fuel tank is as full as possible at all times to prevent moisture from collecting in the fuel tank.
- Ensure that the fuel tank cap is securely tightened.
- Biodiesel blend fuel can damage painted surfaces, remove all spilled fuel from painted surfaces immediately.
- Drain all water from the fuel filter daily before operating the machine.
- Do not exceed engine oil change interval. Extended oil change intervals can cause engine damage.
- Before machine storage; drain the fuel tank, refill with 100% petroleum diesel fuel, add fuel stabiliser, and operate the engine for at least 30 minutes.

**NOTE: Biodiesel blend fuel does not have long term stability and should not be stored for more than 3 months.**

FUEL SYSTEM (CONT'D)

Filling The Fuel Tank

**! WARNING**

**AVOID INJURY OR DEATH**

Stop and cool the engine before adding fuel. **NO SMOKING!** Failure to obey warnings can cause an explosion or fire.

W-2063-0807

Stop the engine and open the rear door.

Figure 197

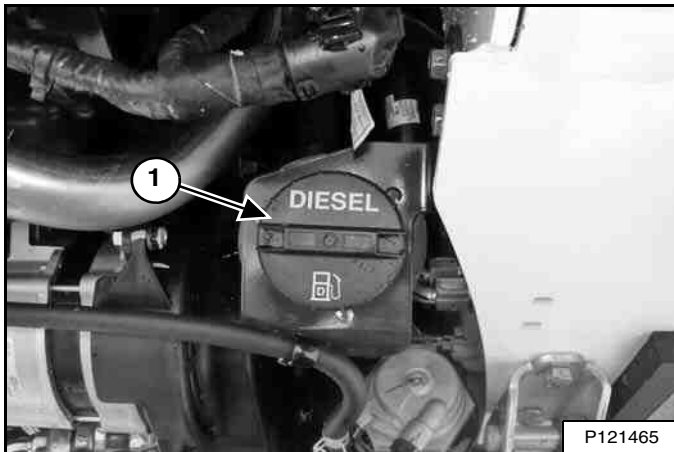

Remove the fuel fill cap (Item 1) [Figure 197].

Figure 198

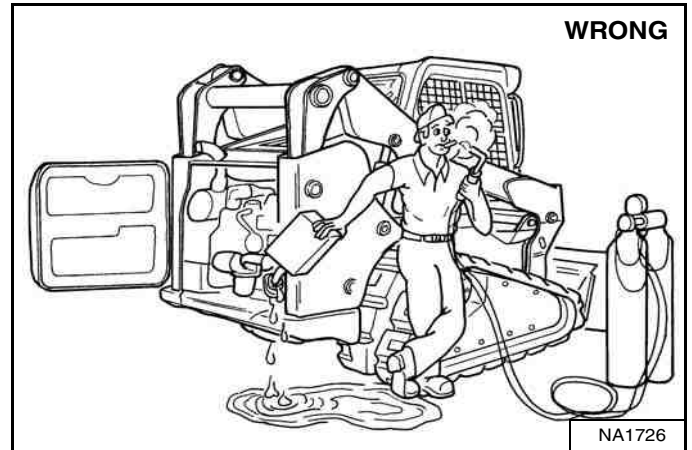

Use a clean, approved safety container to add fuel of the correct specification. Add fuel only in an area that has free movement of air and no open flames or sparks. **NO SMOKING** [Figure 198].

Install and tighten the fuel fill cap (Item 1) [Figure 197].

**NOTE:** The fuel fill cap must be tightened until the cap clicks.

Close the rear door.

**! WARNING**

**AVOID INJURY OR DEATH**

Always clean up spilled fuel or oil. Keep heat, flames, sparks or lighted tobacco away from fuel and oil. Failure to use care around combustibles can cause explosion or fire.

W-2103-0508

## FUEL SYSTEM (CONT'D)

### Fuel Filter

#### Removing Water

See the SERVICE SCHEDULE for the correct service interval. (See SERVICE SCHEDULE on Page 123.)

Stop the engine and open the rear door.

Figure 199

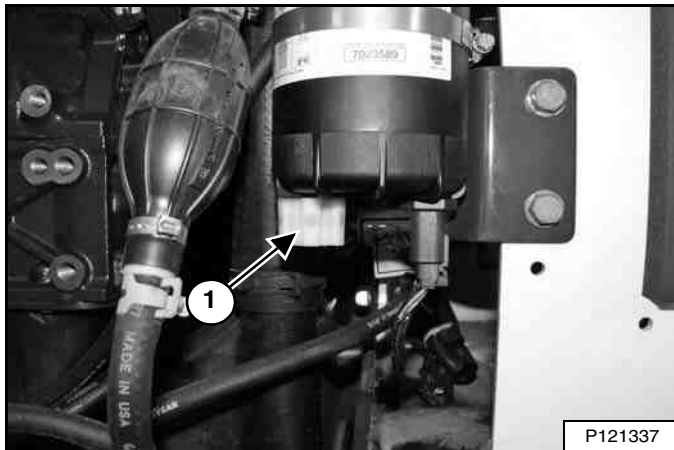

Loosen the drain (Item 1) [Figure 199] at the bottom of the filter to remove trapped water from the filter.

Securely tighten the drain.

## WARNING

### AVOID INJURY OR DEATH

Always clean up spilled fuel or oil. Keep heat, flames, sparks or lighted tobacco away from fuel and oil. Failure to use care around combustibles can cause explosion or fire.

W-2103-0508

Close the rear door.

#### Replacing Element

See the SERVICE SCHEDULE for the correct service interval. (See SERVICE SCHEDULE on Page 123.)

Stop the engine and open the rear door.

Figure 200

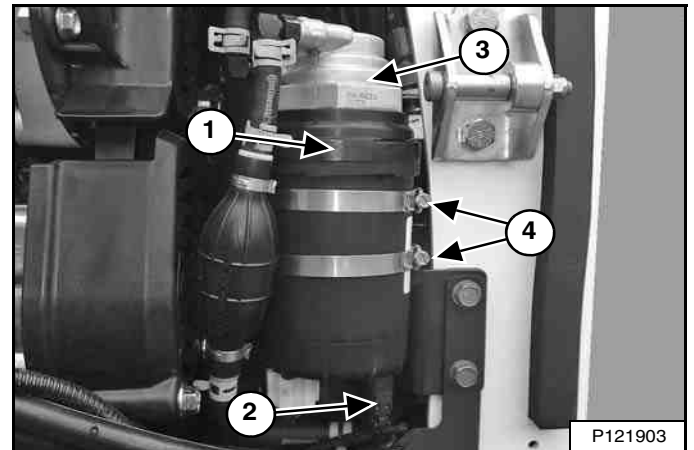

Disconnect the electrical connector (Item 2) [Figure 200].

Loosen the fuel filter head (Item 3) from the fuel filter element (Item 1) [Figure 200]. Do NOT remove the hoses from the fuel filter head.

Loosen the clamps (Item 4) [Figure 200].

Remove the fuel filter element (Item 1) from the fuel filter head (Item 3) [Figure 200].

**NOTE: Do NOT fill the new fuel filter element with fuel at this time.**

Put clean oil on the two new fuel filter element O-rings, install the element, and tighten to 13,5 N•m (10 ft-lb) torque.

Install the fuel filter assembly into the clamps and tighten. Connect the electrical connector [Figure 200].

Remove air from the fuel system. (See Removing Air From The Fuel System on Page 146.)

**FUEL SYSTEM (CONT'D)**

**Fuel Filter (Cont'd)**

*Replacing Element (Cont'd)*

**! WARNING**

**AVOID INJURY OR DEATH**

Always clean up spilled fuel or oil. Keep heat, flames, sparks or lighted tobacco away from fuel and oil. Failure to use care around combustibles can cause explosion or fire.

W-2103-0508

Close the rear door.

Start the engine and allow to operate for one minute.

**! WARNING**

**AVOID INJURY OR DEATH**

Diesel fuel or hydraulic fluid under pressure can penetrate skin or eyes, causing serious injury or death. Fluid leaks under pressure may not be visible. Use a piece of cardboard or wood to find leaks. Do not use your bare hand. Wear safety goggles. If fluid enters skin or eyes, get immediate medical attention from a doctor familiar with this injury.

W-2072-EN-0909

Stop the engine and check for leaks at the filter.

**Removing Air From The Fuel System**

After replacing the filter element or if the fuel tank has run out of fuel, the air must be removed from the fuel system before starting the engine.

**! WARNING**

**AVOID INJURY OR DEATH**

Diesel fuel or hydraulic fluid under pressure can penetrate skin or eyes, causing serious injury or death. Fluid leaks under pressure may not be visible. Use a piece of cardboard or wood to find leaks. Do not use your bare hand. Wear safety goggles. If fluid enters skin or eyes, get immediate medical attention from a doctor familiar with this injury.

W-2072-EN-0909

**Figure 201**

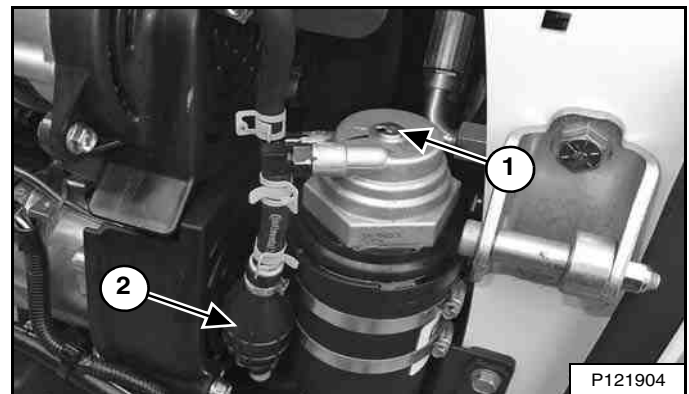

Open the air vent plug (Item 1) [Figure 201] on the fuel filter assembly three full turns.

Squeeze the hand pump (priming bulb) (Item 2) [Figure 201] until fuel flows from the air vent plug with no air bubbles.

Close the air vent plug (Item 1) [Figure 201].

**! WARNING**

**AVOID INJURY OR DEATH**

Always clean up spilled fuel or oil. Keep heat, flames, sparks or lighted tobacco away from fuel and oil. Failure to use care around combustibles can cause explosion or fire.

W-2103-0508

## DIESEL EXHAUST FLUID (DEF) / ADBLUE® SYSTEM

### Description

The engine exhaust system is equipped with a selective catalytic reduction (SCR) system. The SCR is an emissions reduction system that removes nitrogen oxides from the exhaust gases.

The machine will periodically perform a process to clean sulfur oxides from the SCR system. This process is called DeSOX. (See SELECTIVE CATALYTIC REDUCTION (SCR) SYSTEM on Page 53.)

The SCR system requires Diesel Exhaust Fluid (DEF) / AdBlue® to function correctly.

**NOTE: Diesel exhaust fluid (DEF) and AdBlue® are different names for the same fluid. See your Bobcat dealer for more information.**

The SCR system will use one tankful of DEF / AdBlue® for approximately two to four tankfuls of diesel fuel.

The DEF / AdBlue® level indicator is located on the left panel. (See Left Panel on Page 38.)

### Filling The DEF / AdBlue® Tank

Stop the engine.

**NOTE: The engine must be stopped with the key switch in the STOP position when filling the DEF / AdBlue® tank.**

Figure 202

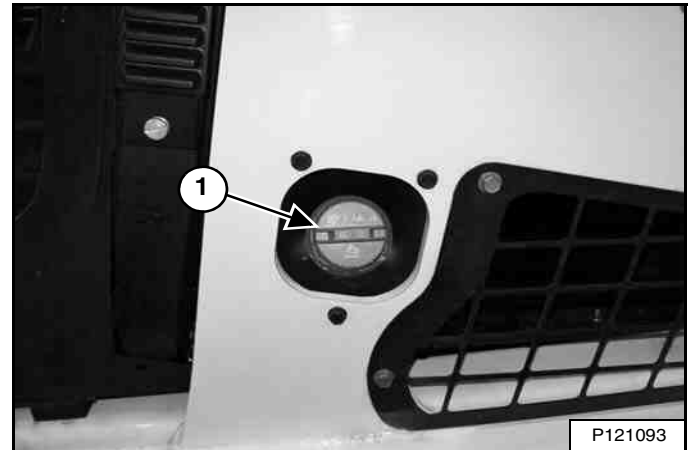

The DEF / AdBlue® fill cap is located on the left side of the machine. Remove the fill cap (Item 1) [Figure 202].

Add only clean, unused DEF / AdBlue®. (See Capacities on Page 217.)

Install and tighten the fill cap (Item 1) [Figure 202].

**NOTE: The DEF / AdBlue® fill cap must be tightened until the cap clicks.**

## ENGINE LUBRICATION SYSTEM

### Checking And Adding Engine Oil

Check the engine oil level every day before starting the engine for the work shift.

Figure 203

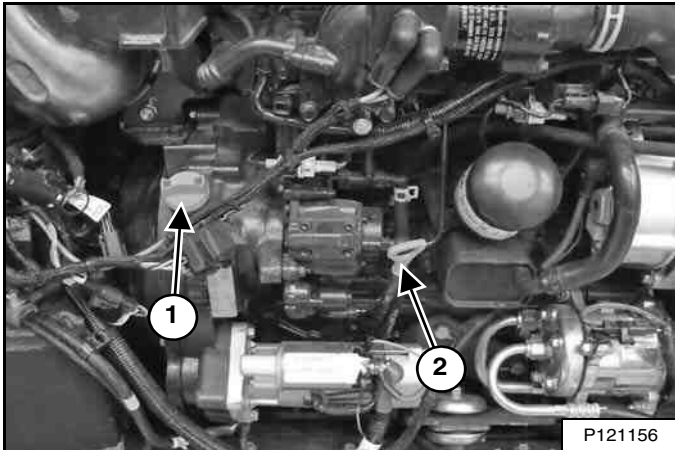

Park the loader on a level surface. Stop the engine. Open the rear door and remove the dipstick (Item 2) [Figure 203].

Keep the oil level between the marks on the dipstick. Do not overfill.

Remove the oil fill cap (Item 1) [Figure 203] to add engine oil.

## WARNING

### AVOID INJURY OR DEATH

Always clean up spilled fuel or oil. Keep heat, flames, sparks or lighted tobacco away from fuel and oil. Failure to use care around combustibles can cause explosion or fire.

W-2103-0508

Close the rear door.

### Engine Oil Chart

Figure 204

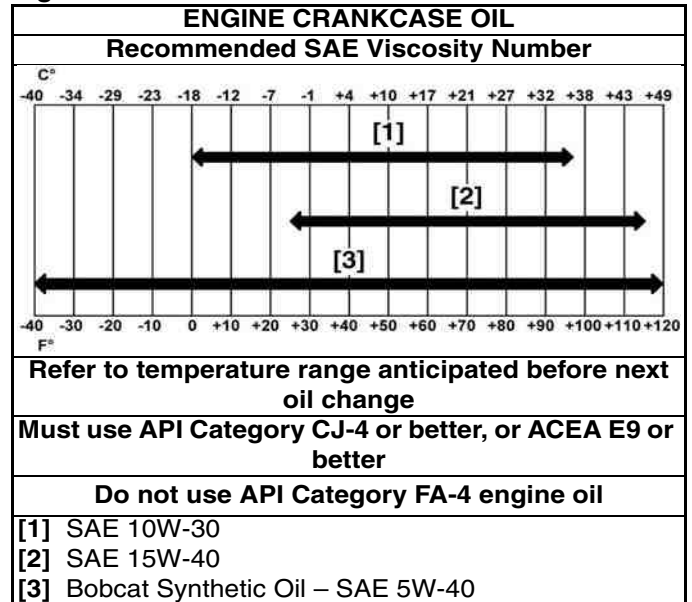

Bobcat engine oils are recommended for use in this machine. If Bobcat engine oil is not available, use a good quality engine oil that meets API Service Category of CJ-4 or better, or ACEA E9 or better [Figure 204].

## IMPORTANT

### AVOID ENGINE DAMAGE

Use of API Service Category FA-4 engine oil is not approved and may cause irreversible damage to the engine.

I-2384-0916

## ENGINE LUBRICATION SYSTEM (CONT'D)

### Removing And Replacing Oil And Filter

See the SERVICE SCHEDULE for the correct service interval. (See SERVICE SCHEDULE on Page 123.)

Operate the engine until coolant reaches normal operating temperature. Stop the engine.

**Figure 205**

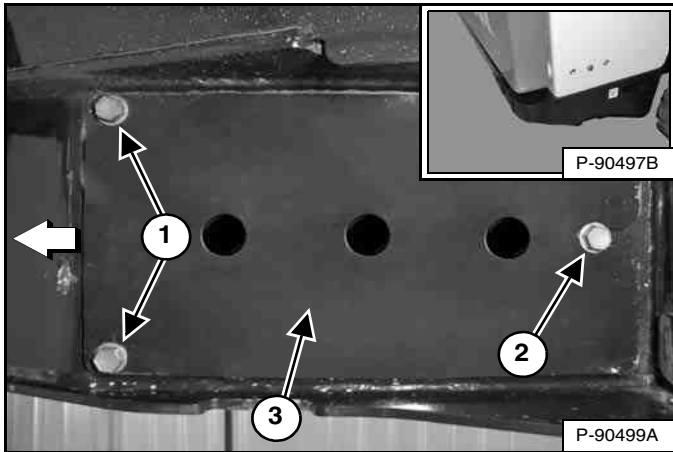

The oil drain hose is located behind a cover under the right rear corner of the loader (Inset) [Figure 205].

Remove two cover mounting bolts (Item 1) [Figure 205].

Loosen one cover mounting bolts (Item 2) and slide the cover (Item 3) [Figure 205] to the rear of the loader to remove.

**Figure 206**

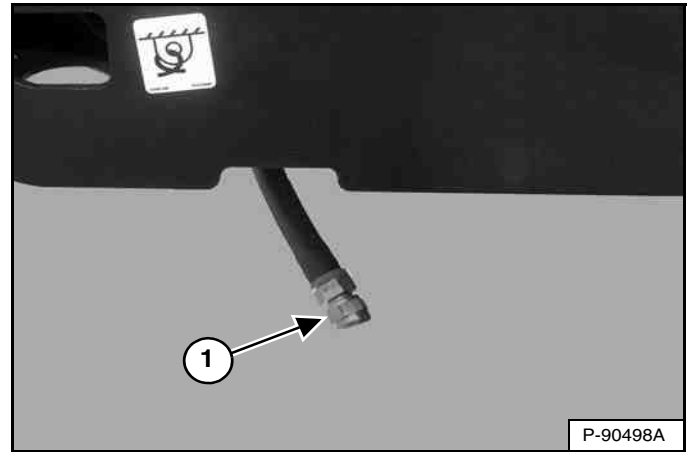

Remove the oil drain cap (Item 1) [Figure 206] from the oil drain hose and drain the oil into a container. Recycle or dispose of used oil in an environmentally safe manner.

Install and tighten the oil drain cap [Figure 206].

Install the cover and the cover mounting bolts [Figure 205]. Tighten all bolts.

Open the rear door.

**ENGINE LUBRICATION SYSTEM (CONT'D)**

**Removing And Replacing Oil And Filter (Cont'd)**

**Figure 207**

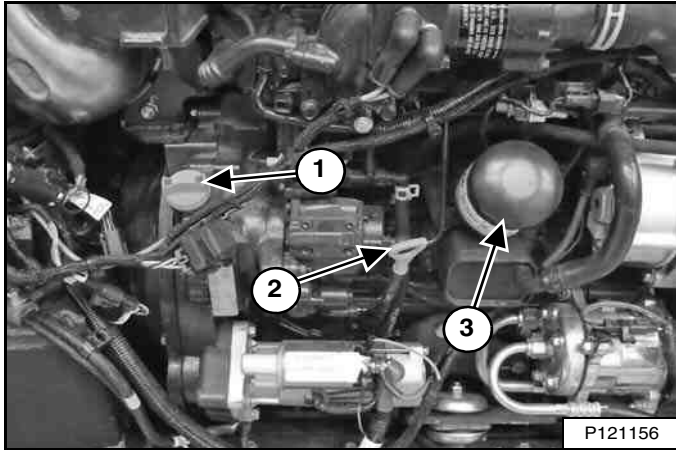

Remove the oil filter (Item 3) [Figure 207] and clean the filter base.

Put clean oil on the new filter gasket, install the new filter, and hand tighten. Use genuine Bobcat filter only.

Remove the oil fill cap (Item 1) [Figure 207].

Put oil into the engine and replace the oil fill cap. (See Capacities on Page 217.) Do not overfill.

Start the engine and allow to operate for several minutes.



**AVOID INJURY OR DEATH**

Diesel fuel or hydraulic fluid under pressure can penetrate skin or eyes, causing serious injury or death. Fluid leaks under pressure may not be visible. Use a piece of cardboard or wood to find leaks. Do not use your bare hand. Wear safety goggles. If fluid enters skin or eyes, get immediate medical attention from a doctor familiar with this injury.

W-2072-EN-0909

Stop the engine and check for leaks at the filter.

Remove the dipstick (Item 2) [Figure 207] and check the oil level.

Add oil as needed if oil level is not at the top mark on the dipstick.

Install the dipstick and close the rear door.



**AVOID INJURY OR DEATH**

Always clean up spilled fuel or oil. Keep heat, flames, sparks or lighted tobacco away from fuel and oil. Failure to use care around combustibles can cause explosion or fire.

W-2103-0508



## ENGINE COOLING SYSTEM

Check the cooling system every day to prevent overheating, loss of performance, or engine damage.

### Maintenance Platform

Figure 208

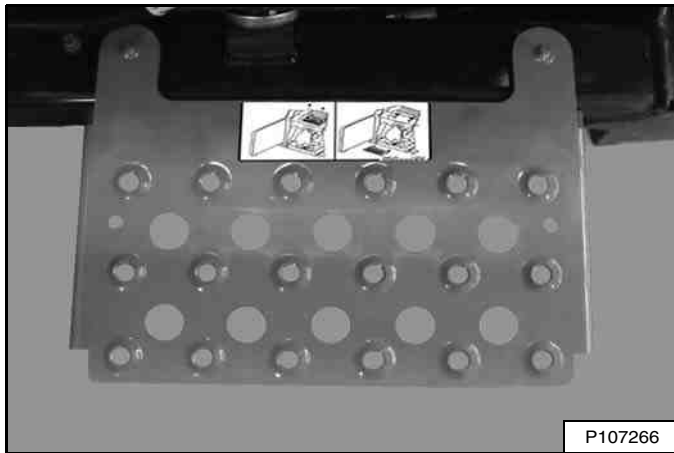

A maintenance platform [Figure 208] is available from your Bobcat dealer to facilitate access when cleaning the engine cooling system.

### Cleaning

See the SERVICE SCHEDULE for the correct service interval. (See SERVICE SCHEDULE on Page 123.)

Stop the engine.

## WARNING

### AVOID INJURY OR DEATH

Wear safety glasses to prevent eye injury when any of the following conditions exist:

- When fluids are under pressure.
- Flying debris or loose material is present.
- Engine is running.
- Tools are being used.

W-2019-0907

Figure 209

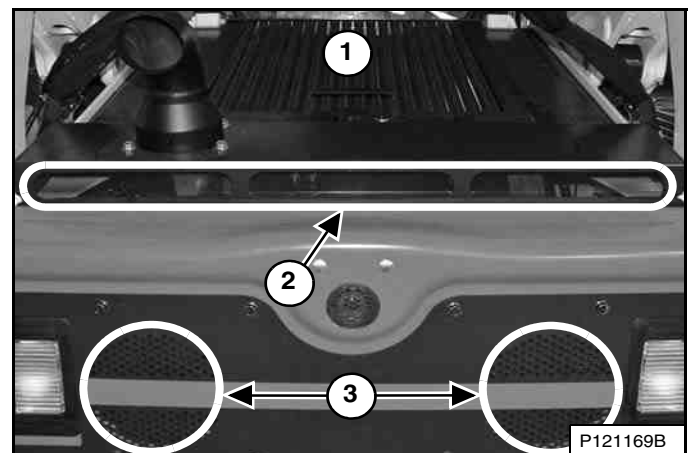

Use low air pressure or low water pressure to clean the top of the rear grille (Item 1) [Figure 209].

Use low air pressure or low water pressure to clean the engine cover screen (Item 2) [Figure 209].

Use low air pressure or low water pressure to clean the rear door fan screens (Item 3) [Figure 209].

Remove the rear grille. (See REAR GRILLE on Page 137.)

## ENGINE COOLING SYSTEM (CONT'D)

### Cleaning (Cont'd)

#### Loaders With Air Conditioning

**Figure 210**

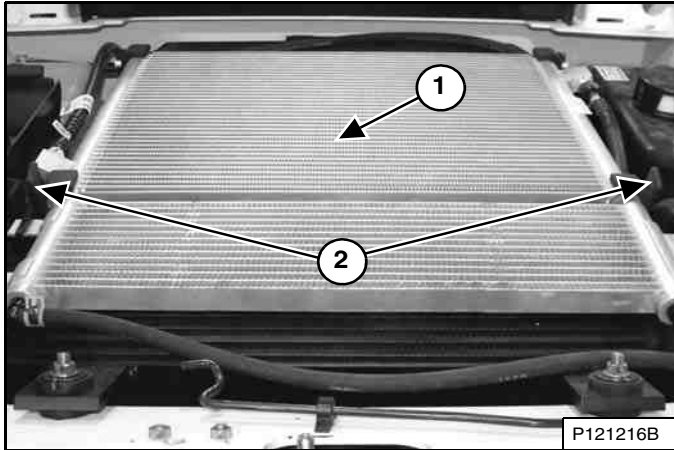

Use low air pressure or low water pressure to clean the top of the air conditioning condenser (Item 1) [Figure 210].

Unhook the two rubber straps (Item 2) [Figure 210].

**NOTE:** The air conditioning condenser fits into two slotted brackets mounted on the hydraulic fluid cooler and radiator assembly. Ensure the air conditioning condenser remains connected to the brackets when raising and lowering.

**Figure 211**

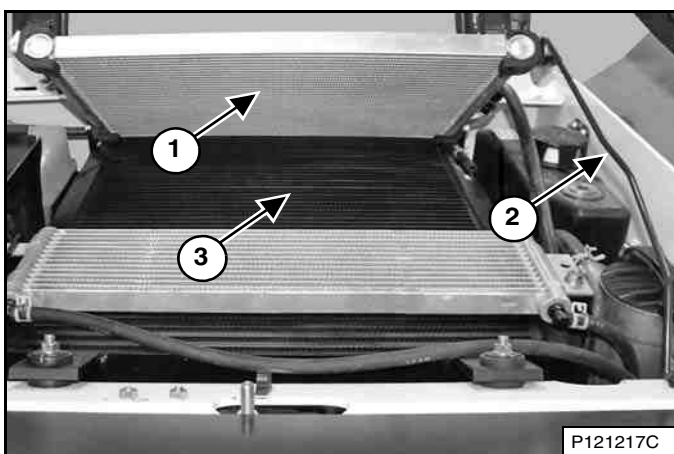

Pivot the air conditioning condenser (Item 1) up and rotate the support bar (Item 2) [Figure 211] into position.

Use low air pressure or low water pressure to clean the top of the hydraulic fluid cooler and radiator assembly (Item 3) [Figure 211].

Return the support bar to storage position and lower the air conditioning condenser.

**Figure 212**

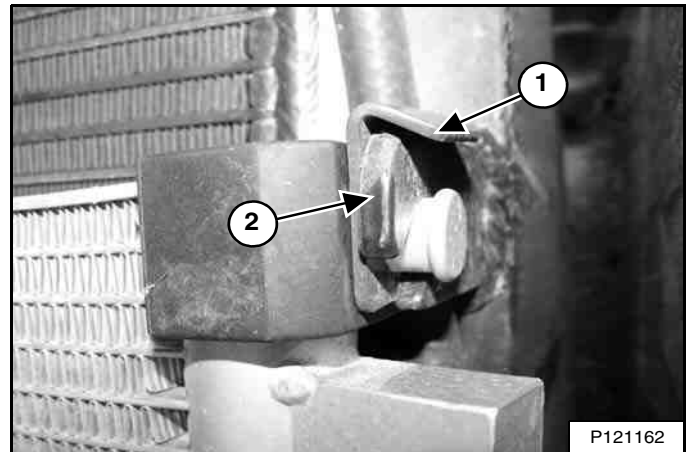

Ensure the air conditioning condenser is installed into the two slotted brackets [Figure 212]. (Right side shown.)

Ensure the clips (Item 1) are properly installed over the two slotted brackets (Item 2) [Figure 212]. (Right side shown.)

Fasten the two rubber straps [Figure 210].

**NOTE:** The air conditioning condenser can be lifted out of the two slotted brackets by removing the clips. This allows greater access to clean the hydraulic fluid cooler and radiator assembly.

**NOTE:** Be careful when removing and installing the air conditioning condenser so that the air conditioning condenser does not fall on the hydraulic fluid cooler and radiator assembly and damage the fins.

Skip ahead to *All Loaders*. (See *All Loaders* on Page 153.)

## ENGINE COOLING SYSTEM (CONT'D)

### Cleaning (Cont'd)

*Loaders Without Air Conditioning*

**Figure 213**

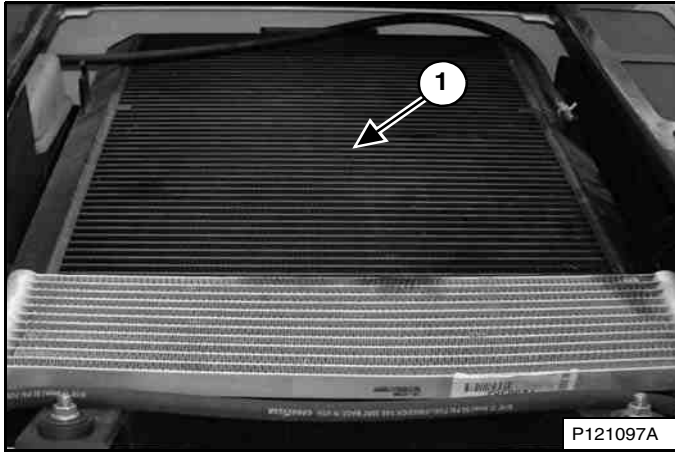

Use low air pressure or low water pressure to clean the top of the hydraulic fluid cooler and radiator assembly (Item 1) [Figure 213].

*All Loaders*

**Figure 214**

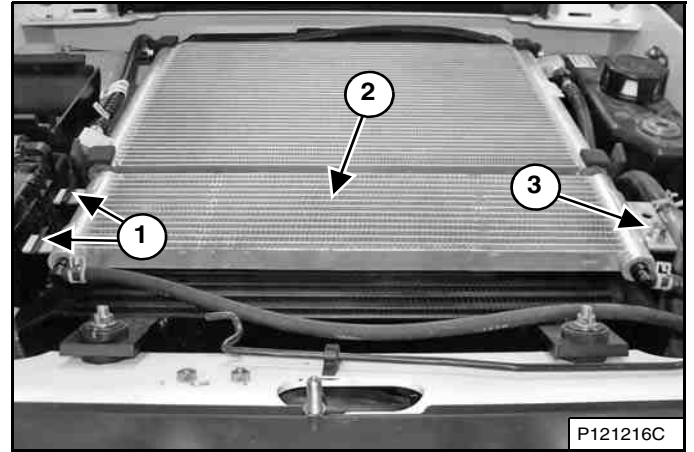

Use low air pressure or low water pressure to clean the top of the fuel cooler (Item 2) [Figure 214].

The area between the fuel cooler and the hydraulic fluid cooler and radiator assembly will require occasional cleaning. Remove the bolt (Item 2) and lift the fuel cooler up while sliding out of the brackets (Item 1) [Figure 214].

**NOTE:** Be careful when removing and installing the fuel cooler so that the fuel cooler does not fall on the hydraulic fluid cooler and radiator assembly and damage the fins.

Install the fuel cooler into the brackets. Install and tighten the bolt [Figure 214].

Check the cooling system for leaks.

Install the rear grille.

## ENGINE COOLING SYSTEM (CONT'D)

### Checking And Adding Coolant

Check the engine coolant level every day before starting the engine for the work shift.

Stop the engine and remove the rear grille. (See REAR GRILLE on Page 137.)

Figure 215

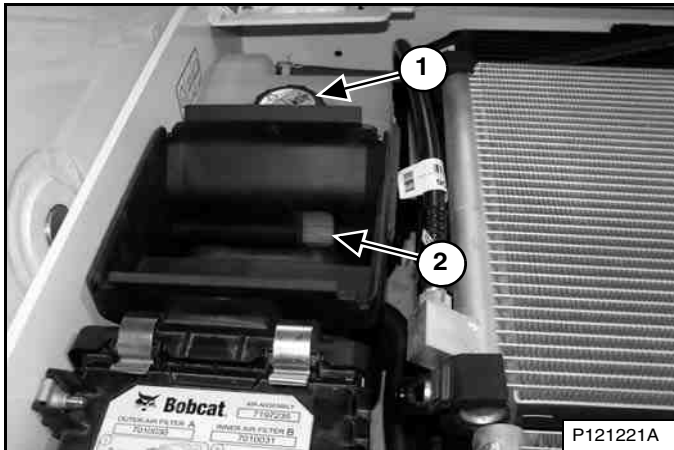

Coolant must be between the top and bottom level markers (Item 2) [Figure 215] when the engine is cold.

**NOTE: The loader is factory filled with propylene glycol coolant (purple colour). DO NOT mix propylene glycol with ethylene glycol.**

Use a refractometer to check the condition of propylene glycol in your cooling system.

## WARNING

### AVOID INJURY

Stop the engine and allow to cool before adding coolant or you can be burned.

W-2106-0907

Remove the coolant fill cap (Item 1) [Figure 215] to add coolant.

The correct mixture of coolant to provide a  $-37^{\circ}\text{C}$  ( $-34^{\circ}\text{F}$ ) freeze protection is 5 L propylene glycol mixed with 4,4 L of water **OR** 1 U.S. gal propylene glycol mixed with 3.5 qt of water.

## IMPORTANT

### AVOID ENGINE DAMAGE

Always use the correct ratio of water to antifreeze.

Too much antifreeze reduces cooling system efficiency and may cause serious premature engine damage.

Too little antifreeze reduces the additives which protect the internal engine components; reduces the boiling point and freeze protection of the system.

Always add a premixed solution. Adding full strength concentrated coolant can cause serious premature engine damage.

I-2124-0497

Add premixed coolant, 47% water and 53% propylene glycol to the coolant tank until the coolant level reaches the upper level marker on the tank [Figure 215].

Install the coolant fill cap [Figure 215].

**NOTE: The coolant fill cap must be tightened until the cap clicks.**

Install the rear grille.

## ENGINE COOLING SYSTEM (CONT'D)

### Removing And Replacing Coolant

See the SERVICE SCHEDULE for the correct service interval. (See SERVICE SCHEDULE on Page 123.)

Stop the engine, open the rear door, and remove the rear grille. (See REAR GRILLE on Page 137.)

# ! WARNING

## AVOID INJURY

Do not remove engine coolant cap when the engine is hot. You can be seriously burned.

W-2607-0804

**NOTE:** This procedure requires the use of a spare 19mm (0.75 in) coolant hose approximately 600 mm (24 in) long.

Figure 216

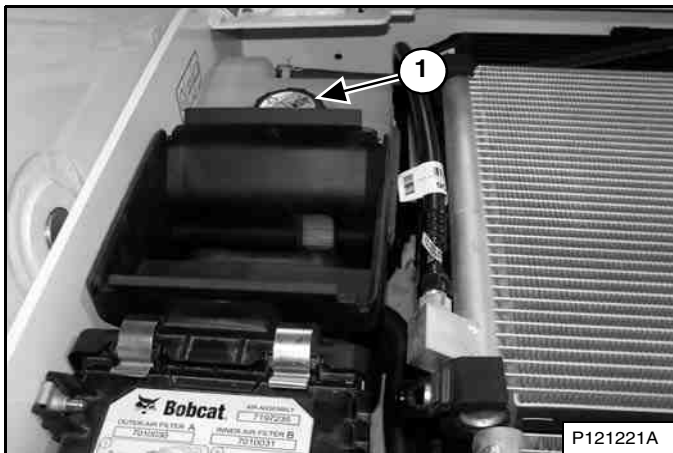

Remove the coolant fill cap (Item 1) [Figure 216].

Figure 217

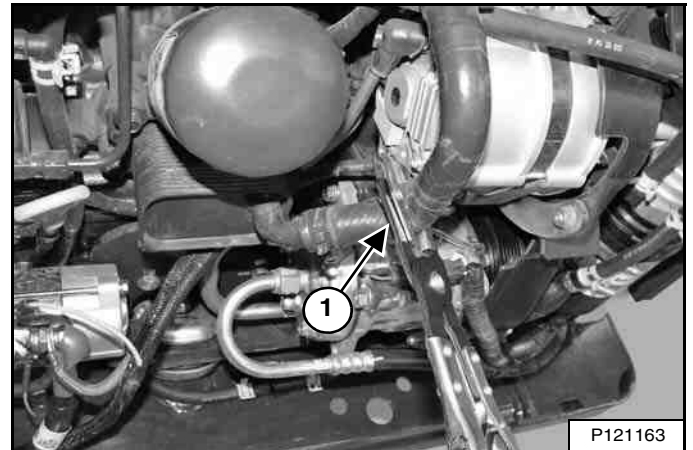

Pinch off the coolant hose attached to the engine oil cooler using a locking hose pinching plier (Item 1) [Figure 217] or similar tool.

Install the coolant fill cap (Item 1) [Figure 216].

Figure 218

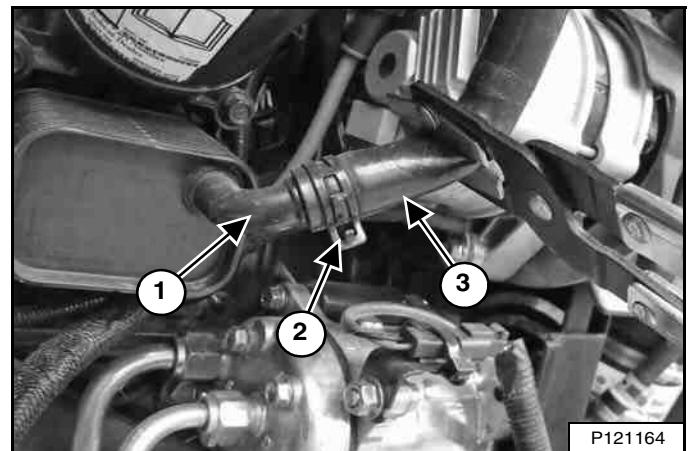

Remove the clamp (Item 2) and disconnect the hose (Item 3) from the engine oil cooler fitting (Item 1) [Figure 218].

Quickly install the spare 19 mm (0.75 in) coolant hose onto the engine oil cooler fitting.

Drain the coolant into a container.

## ENGINE COOLING SYSTEM (CONT'D)

### Removing And Replacing Coolant (Cont'd)

Figure 219

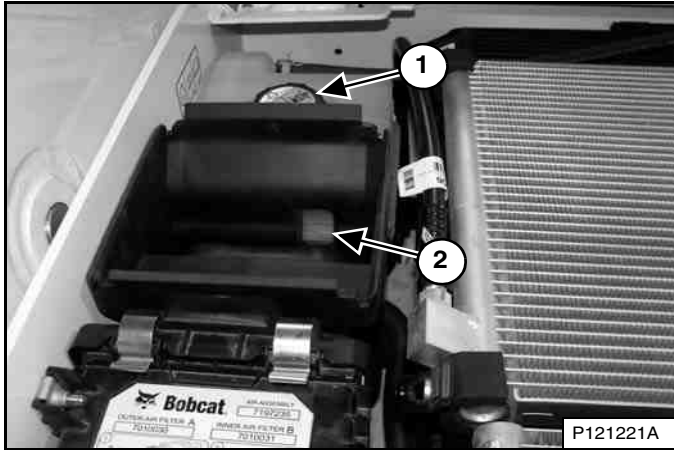

Remove the coolant fill cap (Item 1) [Figure 219] to drain the coolant faster.

Remove the spare 19 mm (0.75 in) coolant hose from the engine oil cooler fitting when the coolant has drained.

Figure 220

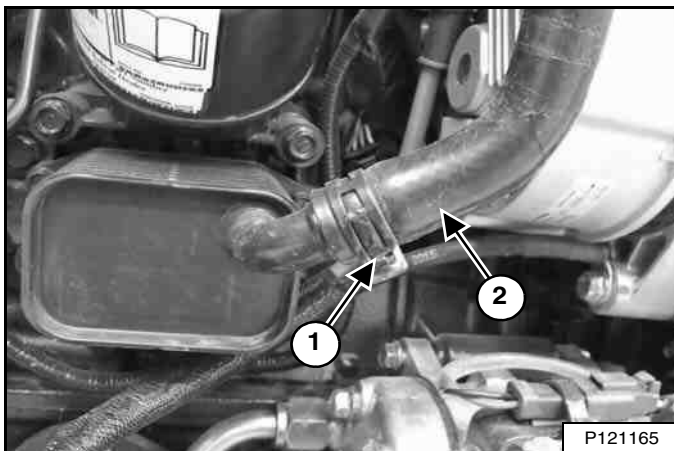

Install the coolant hose (Item 2) onto the engine oil cooler fitting and install the clamp (Item 1) [Figure 220].

Remove the tool used to pinch off the coolant hose.

Recycle or dispose of used coolant in an environmentally safe manner.

Mix new coolant in a separate container. (See Capacities on Page 217.)

The correct mixture of coolant to provide a -37°C (-34°F) freeze protection is 5 L propylene glycol mixed with 4,4 L of water **OR** 1 U.S. gal propylene glycol mixed with 3.5 qt of water.

## IMPORTANT

### AVOID ENGINE DAMAGE

**Always use the correct ratio of water to antifreeze.**

**Too much antifreeze reduces cooling system efficiency and may cause serious premature engine damage.**

**Too little antifreeze reduces the additives which protect the internal engine components; reduces the boiling point and freeze protection of the system.**

**Always add a premixed solution. Adding full strength concentrated coolant can cause serious premature engine damage.**

I-2124-0497

Add premixed coolant, 47% water and 53% propylene glycol to the coolant tank until the coolant level reaches the lower level marker on the tank (Item 2) [Figure 219].

Install the coolant fill cap (Item 1) [Figure 219].

**NOTE: The coolant fill cap must be tightened until the cap clicks.**

Install the rear grille and close the rear door.

Operate the engine until coolant reaches normal operating temperature. Stop the engine.

Check the coolant level when cool. Add coolant as needed. (See Checking And Adding Coolant on Page 154.)

## ELECTRICAL SYSTEM

### Description

Figure 221

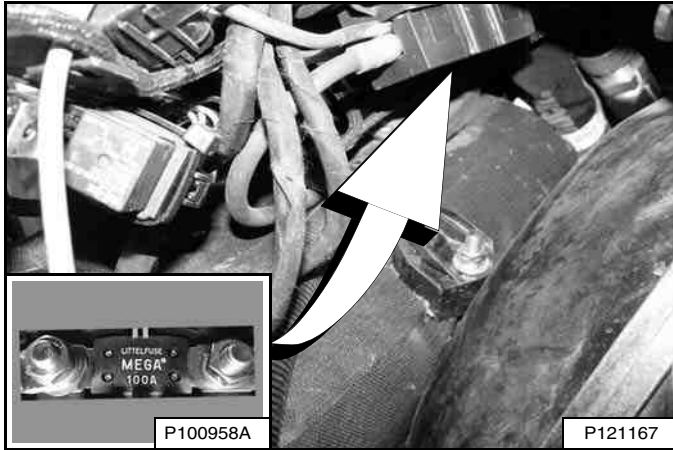

The loader has a 12 volt, negative earth, alternator charging system.

The electrical system is protected by fuses located in the operator cab and a 100 ampere master fuse (Inset) [Figure 221] located above the battery in the engine compartment.

The fuses will protect the electrical system when there is an electrical overload. The reason for the overload must be found before starting the engine again.

### Fuse And Relay Location / Identification

Figure 222

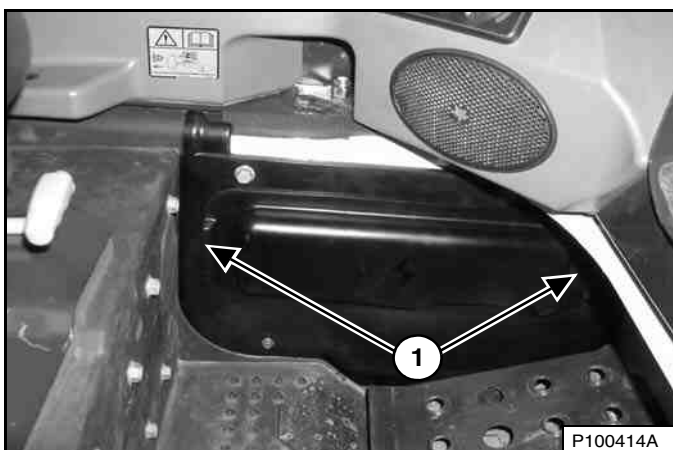

The fuse and relay panel is located behind an access panel near the left foot pedal or footrest. Pull the panel at each end (Item 1) [Figure 222] to remove.

Figure 223

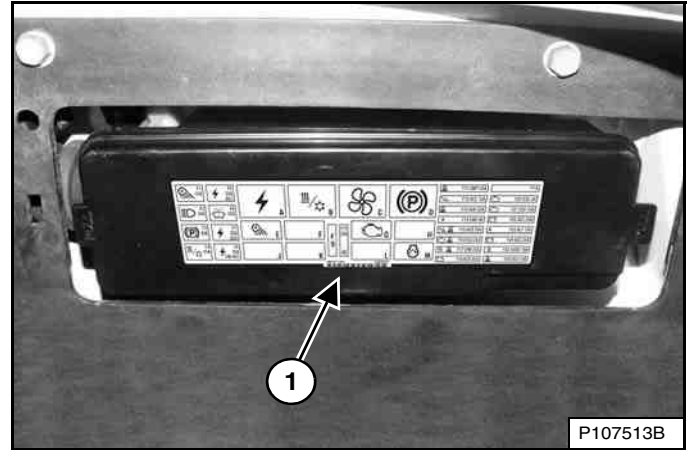

The electrical system is protected from overload by fuses located under the fuse panel cover (Item 1) [Figure 223]. Remove the fuse panel cover by pulling at each end.

A decal located on the fuse panel cover indicates fuse and relay location and fuse amperage ratings.

Figure 224

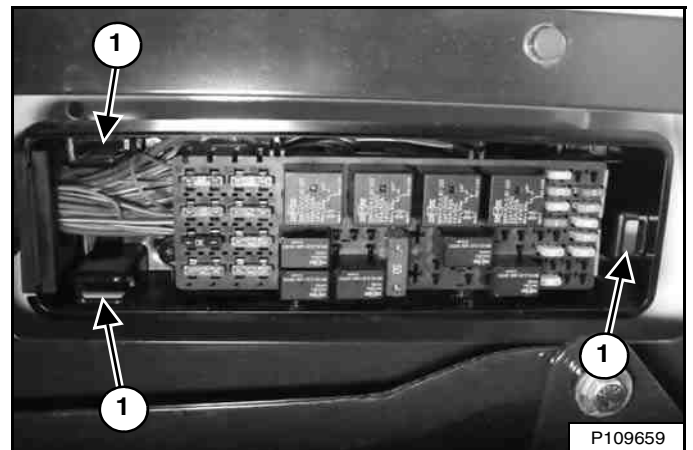

Line up the clips on the back of the fuse panel cover with the slots (Item 1) [Figure 224] in the fuse panel and push the cover into position when finished.

Line up the clips on the access panel with the slots provided and push the panel into position [Figure 222]. A locating pin helps align the panel during installation.

A table is provided with details on amperage ratings and the circuits affected by each fuse and relay. (See Figure 225 on Page 158.) or (See Figure 226 on Page 159.) or (See Figure 227 on Page 160.)



**ELECTRICAL SYSTEM (CONT'D)**

**Fuse And Relay Location / Identification (Cont'd)**

**Figure 225**

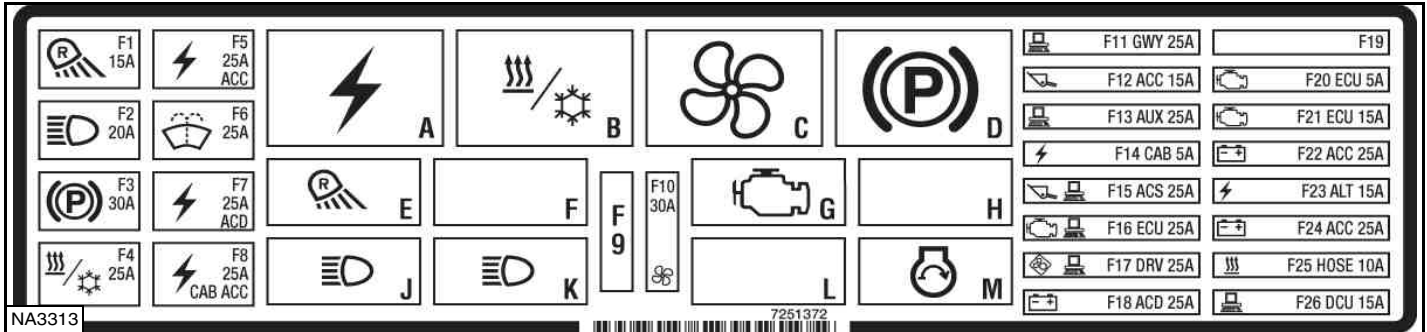

The table below is for earlier models with decal part number 7251372. Fuse location and amperage ratings are shown in the table below and on the decal [Figure 225]. Relays are identified by the letter “R” in the AMP column.

ITEM	ICON	DESCRIPTION	AMP	ITEM	ICON	DESCRIPTION	AMP	ITEM	ICON	DESCRIPTION	AMP
F1		Rear Lights	15	F14		Cab Switched Power	5	A		Switched Power	R
F2		Front Lights	20	F15		ACS Controller	25	B		Heater / HVAC	R
F3		Traction	30	F16		Engine Controller	25	C		Fan	R
F4		Heater / HVAC	25	F17		Drive Controller Back-up Alarm	25	D		Traction	R
F5		Switched Power Back-up Alarm	25	F18		Attachments	25	E		Rear Lights	R
F6		Wiper / Washer	25	F19		Not Used	--	F		Not Used	--
F7		Switched Power	25	F20		Engine Controller	5	G		Engine Controller	R
F8		Cab Switched Power	25	F21		Engine Controller	15	H		Not Used	--
F9		Not Used	--	F22		Accessories and Front Horn	25	J		Front Lights	R
F10		Fan	30	F23		Alternator	15	K		Front Lights	R
F11		Bobcat Controller	25	F24		Cab Accessories Power Port	25	L		Not Used	--
F12		Bucket Position	15	F25		Hose	10	M		Starter	R
F13		Auxiliary Controller	25	F26		Dosing Controller	15				





ELECTRICAL SYSTEM (CONT'D)

Fuse And Relay Location / Identification (Cont'd)

Figure 226

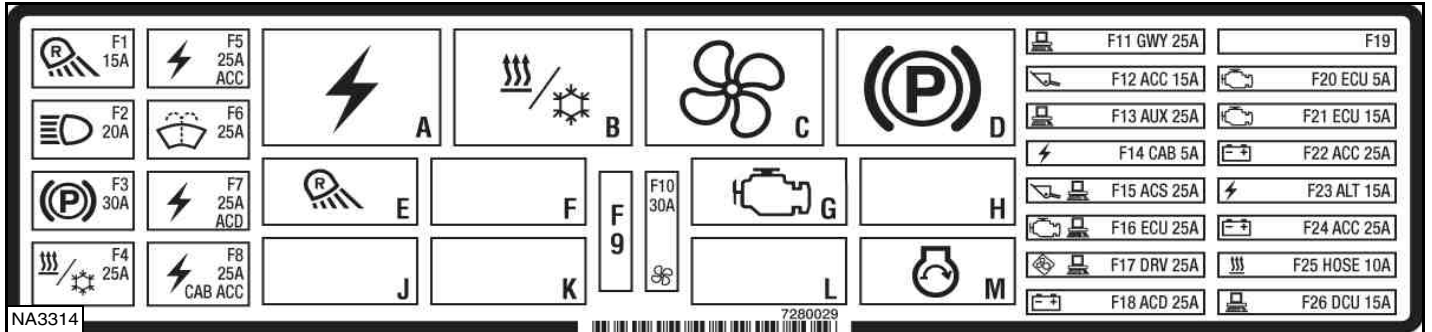

The table below is for later models with decal part number 7280029. Fuse location and amperage ratings are shown in the table below and on the decal [Figure 226]. Relays are identified by the letter “R” in the AMP column.

ITEM	ICON	DESCRIPTION	AMP	ITEM	ICON	DESCRIPTION	AMP	ITEM	ICON	DESCRIPTION	AMP
F1		Rear Lights	15	F14		Cab Switched Power	5	A		Switched Power	R
F2		Front Lights	20	F15		ACS Controller	25	B		Heater / HVAC	R
F3		Traction	30	F16		Engine Controller	25	C		Fan	R
F4		Heater / HVAC	25	F17		Drive Controller Back-up Alarm	25	D		Traction	R
F5		Switched Power Back-up Alarm	25	F18		Attachments	25	E		Rear Lights	R
F6		Wiper / Washer	25	F19		Not Used	--	F		Not Used	--
F7		Switched Power	25	F20		Engine Controller	5	G		Engine Controller	R
F8		Cab Switched Power	25	F21		Engine Controller	15	H		Not Used	--
F9		Not Used	--	F22		Accessories and Front Horn	25	J		Not Used	--
F10		Fan	30	F23		Alternator	15	K		Not Used	--
F11		Bobcat Controller	25	F24		Cab Accessories Power Port	25	L		Not Used	--
F12		Bucket Position	15	F25		Hose	10	M		Starter	R
F13		Auxiliary Controller	25	F26		Dosing Controller	15				



ELECTRICAL SYSTEM (CONT'D)

Fuse And Relay Location / Identification (Cont'd)

Figure 227

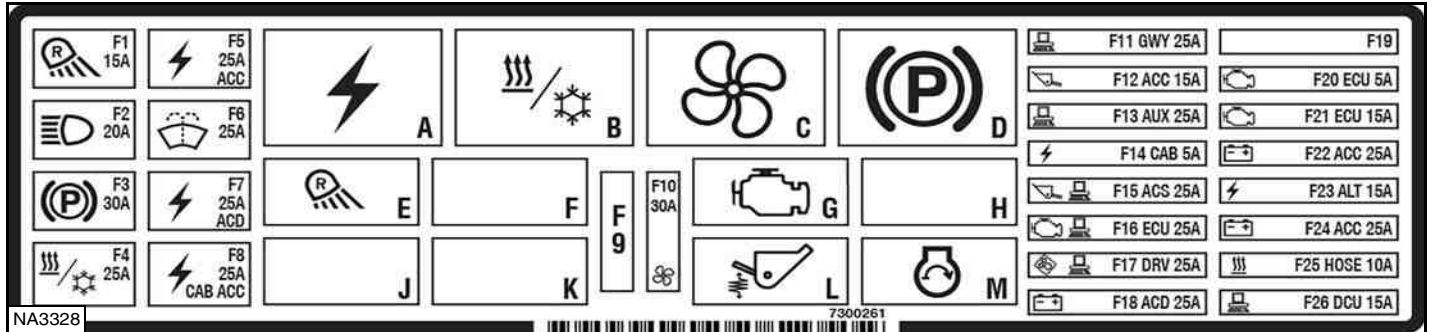

The table below is for later models with decal part number 7300261. Fuse location and amperage ratings are shown in the table below and on the decal [Figure 227]. Relays are identified by the letter “R” in the AMP column.

ITEM	ICON	DESCRIPTION	AMP	ITEM	ICON	DESCRIPTION	AMP	ITEM	ICON	DESCRIPTION	AMP
F1		Rear Lights	15	F14		Cab Switched Power	5	A		Switched Power	R
F2		Front Lights	20	F15		ACS Controller	25	B		Heater / HVAC	R
F3		Traction	30	F16		Engine Controller	25	C		Fan	R
F4		Heater / HVAC	25	F17		Drive Controller Back-up Alarm	25	D		Traction	R
F5		Switched Power Back-up Alarm	25	F18		Attachments	25	E		Rear Lights	R
F6		Wiper / Washer	25	F19		Not Used	--	F		Not Used	--
F7		Switched Power	25	F20		Engine Controller	5	G		Engine Controller	R
F8		Cab Switched Power	25	F21		Engine Controller	15	H		Not Used	--
F9		Not Used	--	F22		Accessories and Front Horn	25	J		Not Used	--
F10		Fan	30	F23		Alternator	15	K		Not Used	--
F11		Bobcat Controller	25	F24		Cab Accessories Power Port	25	L		Automatic Ride Control	R
F12		Bucket Position	15	F25		Hose	10	M		Starter	R
F13		Auxiliary Controller	25	F26		Dosing Controller	15				

ELECTRICAL SYSTEM (CONT'D)

Fuse And Relay Location / Identification (Cont'd)

Figure 228

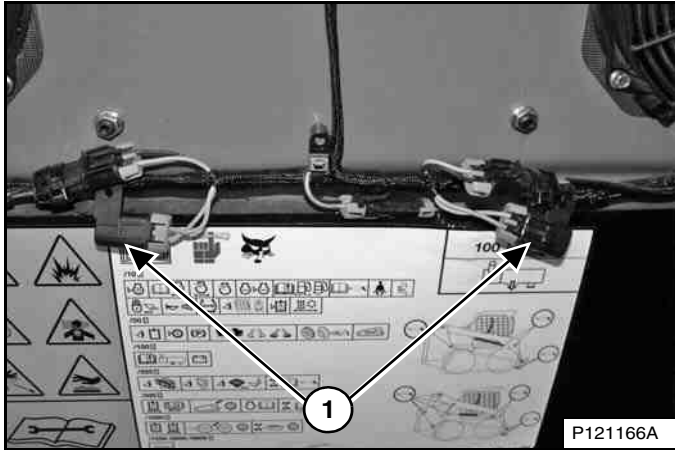

Two 15 ampere inline fuses (Item 1) [Figure 228] for the rear door fans are located on the inside of the rear door.

Figure 229

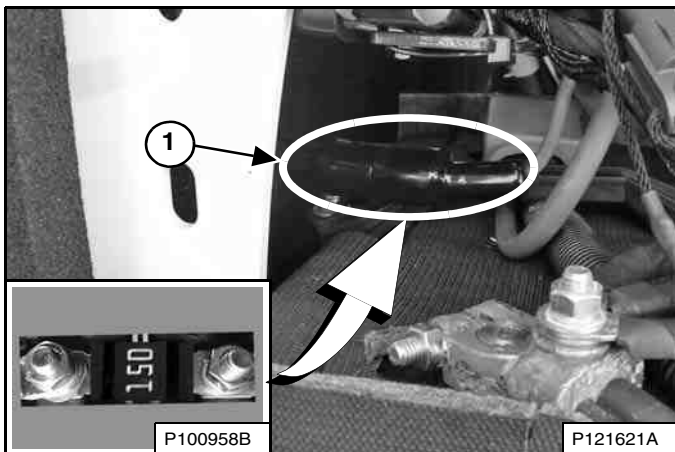

The air intake heater is protected by a 150 ampere inline fuse (Inset) located just above the battery inside a two-piece rubber boot (Item 1) [Figure 229]. Slide the rubber boot apart to access the fuse holder.

Figure 230

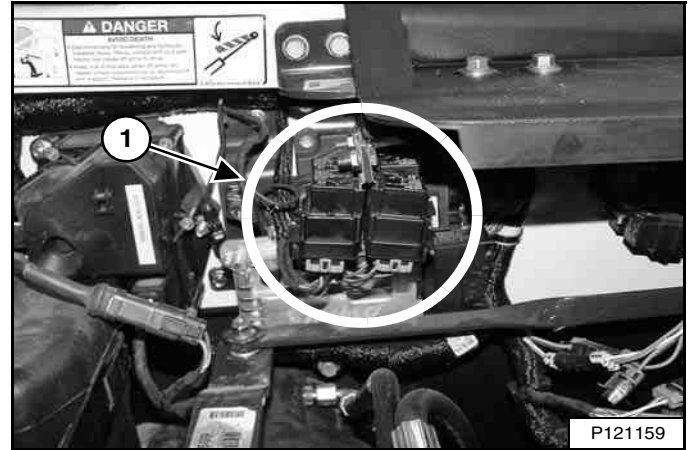

(Earlier models with decal part number 7251372) - Four additional relays (Item 1) [Figure 230] for the DEF / AdBlue® tank heater system are located under the operator cab on the left side of the loader. Stop the engine and raise the operator cab to access the relays. (See Raising on Page 134.)

Figure 231

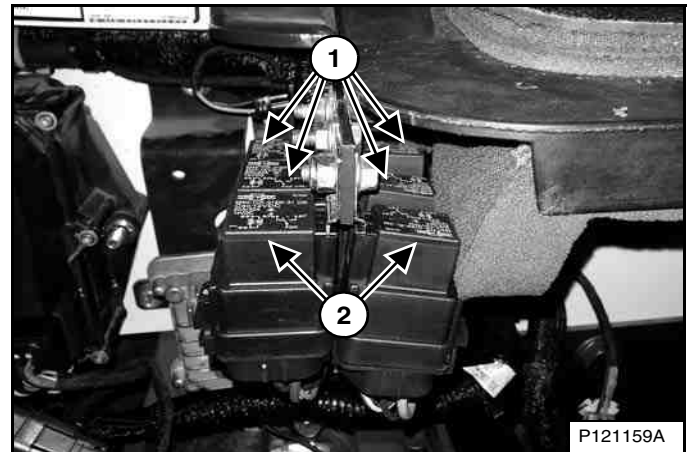

(Later models with decal part number 7280029 or 7300261) - Six additional relays are located under the operator cab on the left side of the loader. Four relays (Item 1) are for the DEF / AdBlue® tank heater system. Two relays (Item 2) [Figure 231] are for the front lights. Stop the engine and raise the operator cab to access the relays. (See Raising on Page 134.)

## ELECTRICAL SYSTEM (CONT'D)

### Battery Maintenance

See the SERVICE SCHEDULE for the correct service interval. (See SERVICE SCHEDULE on Page 123.)

Figure 232

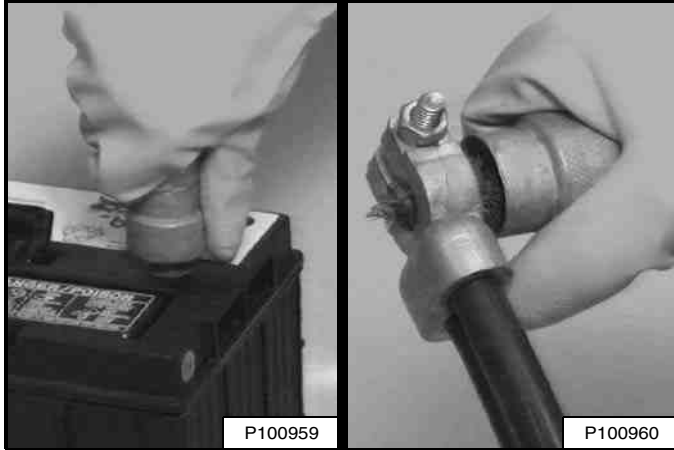

The battery cables must be clean [Figure 232] and tight.

Remove acid or corrosion from battery and cables with sodium bicarbonate (baking soda) and water solution.

Put Bobcat Battery Saver or grease on the battery terminals and cable ends to prevent corrosion.

Check electrolyte level in the battery. Add distilled water as needed.

## WARNING

### AVOID INJURY OR DEATH

Batteries contain acid which burns eyes and skin on contact. Wear goggles, protective clothing and rubber gloves to keep acid off body.

In case of acid contact, wash immediately with water. In case of eye contact get prompt medical attention and wash eye with clean, cool water for at least 15 minutes.

If electrolyte is taken internally drink large quantities of water or milk! DO NOT induce vomiting. Get prompt medical attention.

W-2065-0807

## ELECTRICAL SYSTEM (CONT'D)

### Using A Booster Battery (Jump Starting)

If the engine will not start without using a booster battery, BE CAREFUL! There must be one person in the operator's seat and one person to connect and disconnect the battery cables.

The key switch must be in the STOP position. The booster battery must be 12 volt.

# ! WARNING

## BATTERY GAS CAN EXPLODE AND CAUSE SERIOUS INJURY OR DEATH

Keep arcs, sparks, flames and lighted tobacco away from batteries. When *jumping* from booster battery make final connection (negative) at machine frame.

Do not jump start or charge a frozen or damaged battery. Warm battery to 16°C (60°F) before connecting to a charger. Unplug charger before connecting or disconnecting cables to battery. Never lean over battery while boosting, testing or charging.

W-2066-0910

Open the rear door.

Figure 233

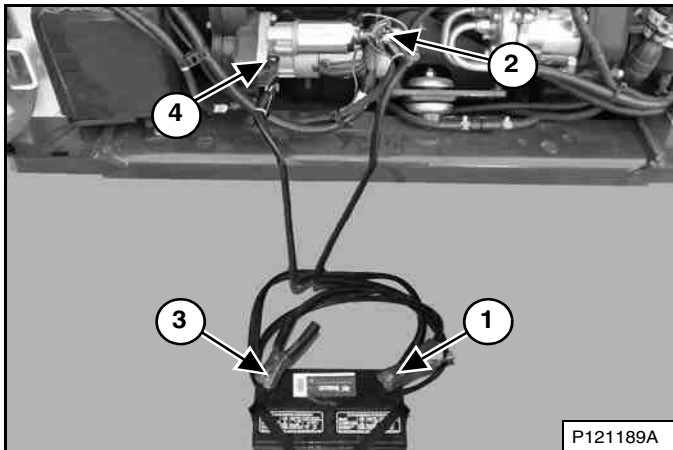

Connect the end of the first cable (Item 1) to the positive (+) terminal of the booster battery. Connect the other end of the same cable (Item 2) [Figure 233] to the positive (+) terminal on the engine starter.

Connect the end of the second cable (Item 3) to the negative (-) terminal of the booster battery. Connect the other end of the same cable (Item 4) [Figure 233] to the engine.

Keep cables away from moving parts. Start the engine. (See STARTING THE ENGINE on Page 95.)

After the engine has started, remove the negative (-) cable (Item 4) first. Remove the cable from the positive (+) terminal (Item 2) [Figure 233].

Remove the cables from the booster battery.

Close the rear door.

# IMPORTANT

Damage to the alternator can occur if:

- Engine is operated with battery cables disconnected.
- Battery cables are connected when using a fast charger or when welding on the loader. (Remove both cables from the battery.)
- Extra battery cables (booster cables) are connected wrong.

I-2023-1285

## ELECTRICAL SYSTEM (CONT'D)

### Removing And Installing Battery

# ! WARNING

#### AVOID INJURY OR DEATH

Batteries contain acid which burns eyes and skin on contact. Wear goggles, protective clothing and rubber gloves to keep acid off body.

In case of acid contact, wash immediately with water. In case of eye contact get prompt medical attention and wash eye with clean, cool water for at least 15 minutes.

If electrolyte is taken internally drink large quantities of water or milk! DO NOT induce vomiting. Get prompt medical attention.

W-2065-0807

Stop the engine and open the rear door.

When removing the battery from the loader, do not touch any metal parts with the battery terminals.

Figure 234

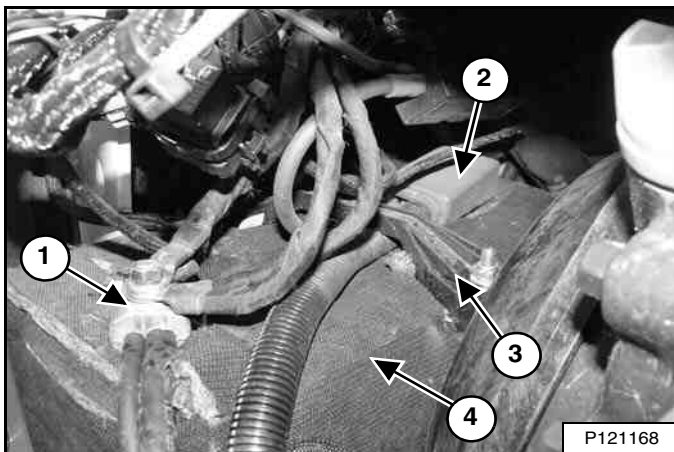

Disconnect the negative (-) cable (Item 1) [Figure 234].

Remove the battery hold-down clamp (Item 3) [Figure 234].

Disconnect the positive (+) cable (Item 2) [Figure 234] from the battery.

Remove the battery wrap (Item 4) [Figure 234] and the battery from the loader.

Figure 235

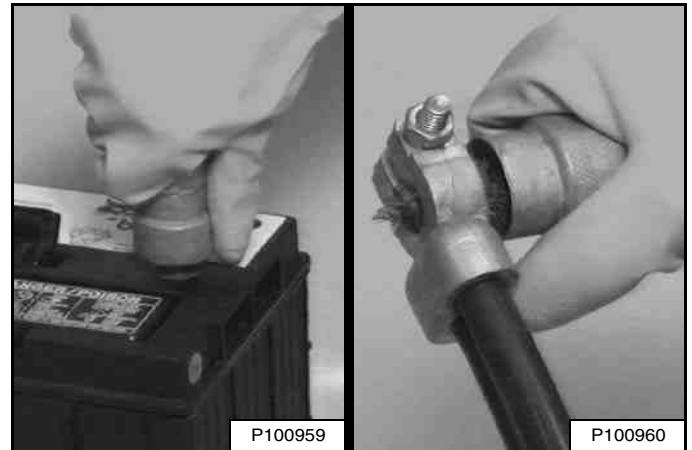

Always clean the battery terminals and cable ends when installing a new or used battery [Figure 235].

When installing the battery into the loader, do not touch any metal parts with the battery terminals.

Adjust battery wrap for proper fit.

Connect the negative (-) cable last to prevent sparks.

Connect and tighten the battery cables.

Install and tighten the battery hold-down clamp.

Put Bobcat Battery Saver or grease on the battery terminals and cable ends to prevent corrosion.

Close the rear door.

# ! WARNING

#### BATTERY GAS CAN EXPLODE AND CAUSE SERIOUS INJURY OR DEATH

Keep arcs, sparks, flames and lighted tobacco away from batteries. When *jumping* from booster battery make final connection (negative) at machine frame.

Do not jump start or charge a frozen or damaged battery. Warm battery to 16°C (60°F) before connecting to a charger. Unplug charger before connecting or disconnecting cables to battery. Never lean over battery while boosting, testing or charging.

W-2066-0910

## HYDRAULIC / HYDROSTATIC SYSTEM

### Checking And Adding Fluid

Check the hydraulic / hydrostatic fluid level every day before starting the work shift.

Park the loader on a level surface, lower the lift arms, and put the attachment flat on the ground or tilt the Bob-Tach fully back if no attachment is installed.

Stop the engine.

Figure 236

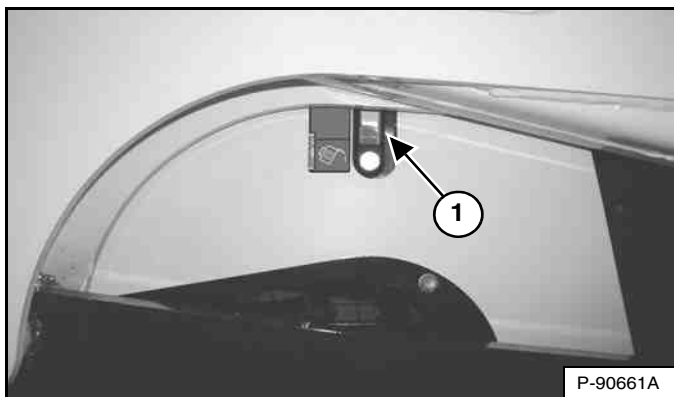

Check the fluid level in the sight gauge (Item 1) [Figure 236]. Keep the fluid level within the operating range.

Remove the rear grille. (See REAR GRILLE on Page 137.)

Figure 237

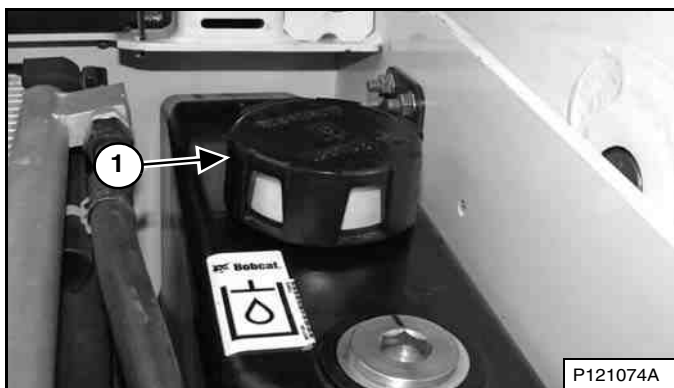

Remove the fill cap (Item 1) [Figure 237].

Add fluid as needed to bring the level within the operating range in the sight gauge [Figure 236].

Install the fill cap [Figure 237] and install the rear grille.

### Hydraulic / Hydrostatic Fluid Chart

Figure 238

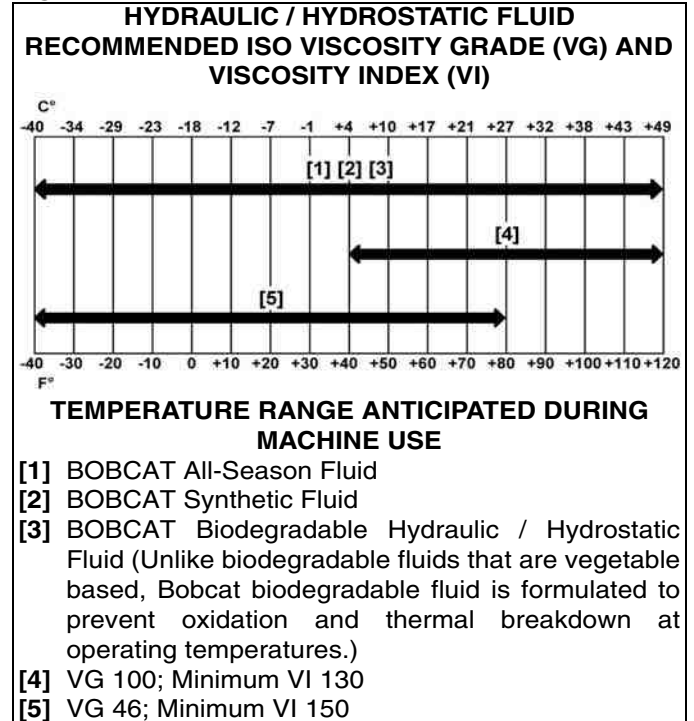

Bobcat hydraulic fluids are recommended for use in this machine. If Bobcat hydraulic fluid is not available, use a good quality hydraulic fluid meeting the viscosity grade and viscosity index shown in the chart [Figure 238].

## ! WARNING

### AVOID INJURY OR DEATH

Always clean up spilled fuel or oil. Keep heat, flames, sparks or lighted tobacco away from fuel and oil. Failure to use care around combustibles can cause explosion or fire.

W-2103-0508

## HYDRAULIC / HYDROSTATIC SYSTEM (CONT'D)

### Removing And Replacing Hydraulic Fluid

See the SERVICE SCHEDULE for the correct service interval. (See SERVICE SCHEDULE on Page 123.)

Replace the fluid if contaminated or after major repair.

Always replace the hydraulic / hydrostatic filter and the hydraulic charge filter whenever the hydraulic fluid is replaced. (See Removing And Replacing Hydraulic / Hydrostatic Filter on Page 168.) and (See Removing And Replacing Hydraulic Charge Filter on Page 169.)

Stop the engine, and remove the rear grille. (See REAR GRILLE on Page 137.)

**Figure 239**

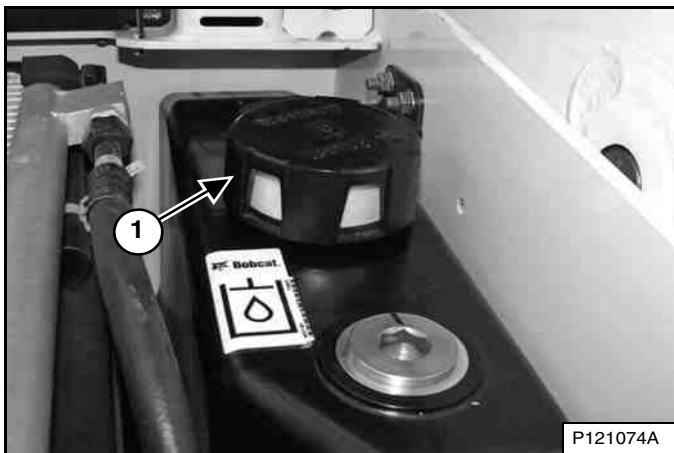

Remove the hydraulic fill cap (Item 1) [Figure 239].

**Figure 240**

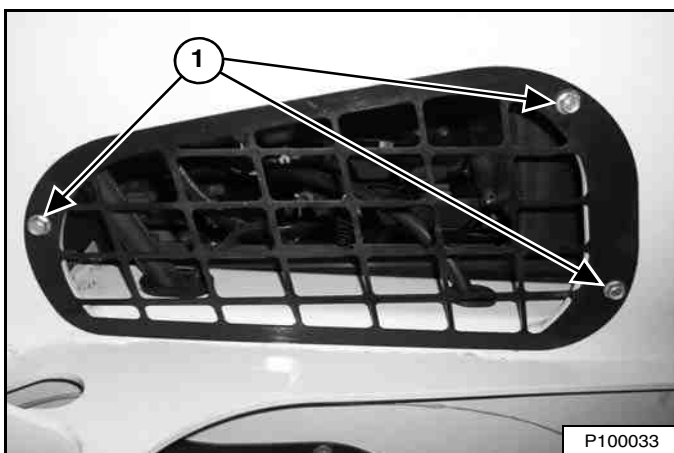

Remove the right side access cover bolts (Item 1) [Figure 240] and remove the access cover. (Lift arms shown raised for visual clarity.)

**Figure 241**

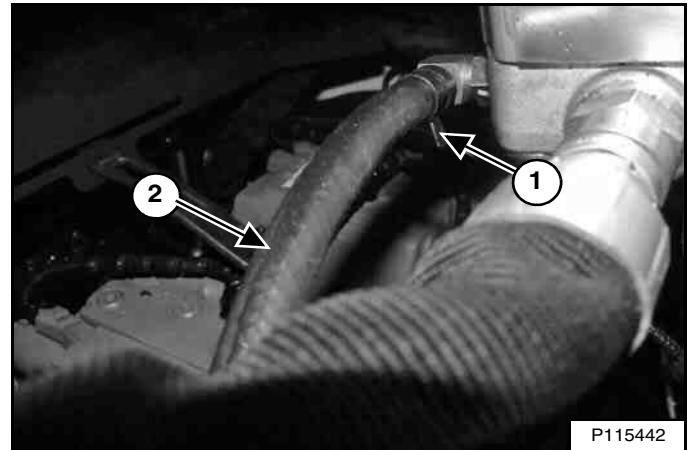

The drain hose is located behind the fan motor.

Remove the clamp (Item 1). Pinch off the hose (Item 2) [Figure 241] near the fitting and disconnect hose from the fitting. Route the hose out the side of the loader and drain the fluid into a container.

Connect the hose to the fitting when the fluid stops draining. Install the clamp [Figure 241].



**HYDRAULIC / HYDROSTATIC SYSTEM (CONT'D)**

**Removing And Replacing Hydraulic Fluid (Cont'd)**

Recycle or dispose of used fluid in an environmentally safe manner.



**AVOID INJURY OR DEATH**

**Always clean up spilled fuel or oil. Keep heat, flames, sparks or lighted tobacco away from fuel and oil. Failure to use care around combustibles can cause explosion or fire.**

W-2103-0508

Install the side access cover and bolts [Figure 240].

**Figure 242**



Remove and clean the hydraulic fill screen (Item 1) [Figure 242]. Use low air pressure to dry the screen.

Install hydraulic fill screen and add the correct fluid to the reservoir until the fluid level is within the operating range of the sight gauge. (See Capacities on Page 217.) and (See Checking And Adding Fluid on Page 165.)

Install the hydraulic fill cap [Figure 239].

Install the rear grille.

Start the engine and operate the loader hydraulic controls.



**AVOID INJURY OR DEATH**

**Diesel fuel or hydraulic fluid under pressure can penetrate skin or eyes, causing serious injury or death. Fluid leaks under pressure may not be visible. Use a piece of cardboard or wood to find leaks. Do not use your bare hand. Wear safety goggles. If fluid enters skin or eyes, get immediate medical attention from a doctor familiar with this injury.**

W-2072-EN-0909

Stop the engine and check for leaks.

Check the fluid level in the reservoir and add as needed. (See Checking And Adding Fluid on Page 165.)

## HYDRAULIC / HYDROSTATIC SYSTEM (CONT'D)

### Removing And Replacing Hydraulic / Hydrostatic Filter

See the SERVICE SCHEDULE for the correct service interval. (See SERVICE SCHEDULE on Page 123.)

Stop the engine and remove the rear grille. (See REAR GRILLE on Page 137.)

Clean the top of the filter housing.

Figure 243

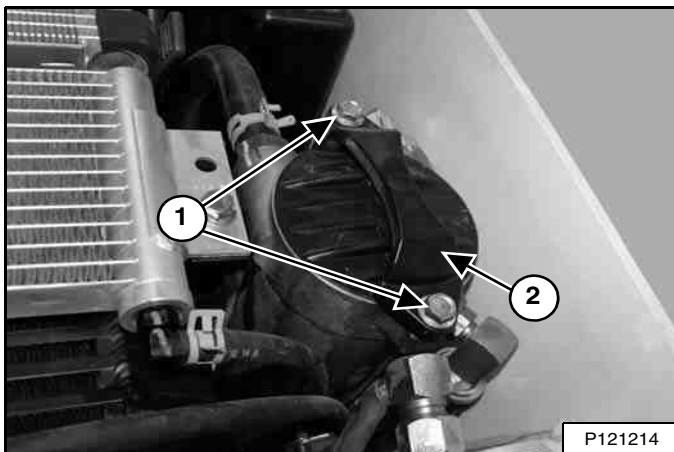

Remove the bolts (Item 1) and rotate the filter cap (Item 2) [Figure 243] slightly.

Slowly pry the filter cap off the housing by hand.

Figure 244

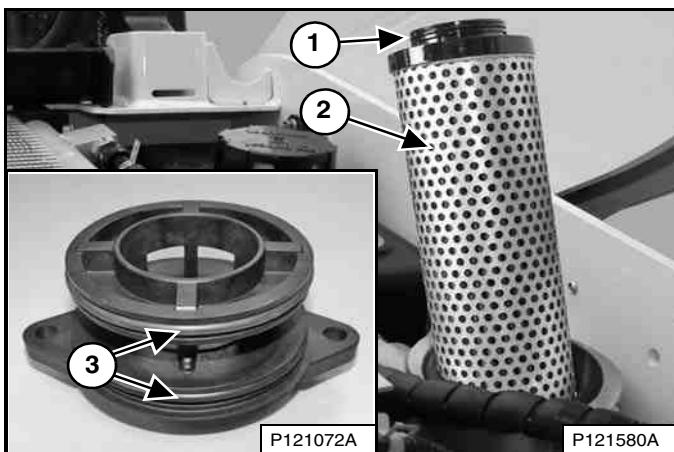

Remove the filter element (Item 2) [Figure 244] and discard.

Lubricate the O-ring (Item 1) [Figure 244] on new filter element with clean oil.

Install new filter element ensuring that element is fully seated in the housing.

Remove the filter cap O-rings (Item 3) [Figure 244] and discard.

Install new filter cap O-rings and lubricate with clean oil.

**NOTE: The filter cap O-rings are not the same size. Take care to install each O-ring in the correct location.**

Install the filter cap and bolts. Alternate tightening the bolts to draw the cap down evenly. Tighten the bolts to 27 – 41N•m (20 – 30 ft-lb) torque.

## WARNING

### AVOID INJURY OR DEATH

Always clean up spilled fuel or oil. Keep heat, flames, sparks or lighted tobacco away from fuel and oil. Failure to use care around combustibles can cause explosion or fire.

W-2103-0508

Install the rear grille.

Start the engine and operate the loader hydraulic controls.

## WARNING

### AVOID INJURY OR DEATH

Diesel fuel or hydraulic fluid under pressure can penetrate skin or eyes, causing serious injury or death. Fluid leaks under pressure may not be visible. Use a piece of cardboard or wood to find leaks. Do not use your bare hand. Wear safety goggles. If fluid enters skin or eyes, get immediate medical attention from a doctor familiar with this injury.

W-2072-EN-0909

Stop the engine and check for leaks at the filter.

Check the fluid level in the reservoir and add as needed. (See Checking And Adding Fluid on Page 165.)

## HYDRAULIC / HYDROSTATIC SYSTEM (CONT'D)

### Removing And Replacing Hydraulic Charge Filter

See the SERVICE SCHEDULE for the correct service interval. (See SERVICE SCHEDULE on Page 123.)

Stop the engine.

Figure 245

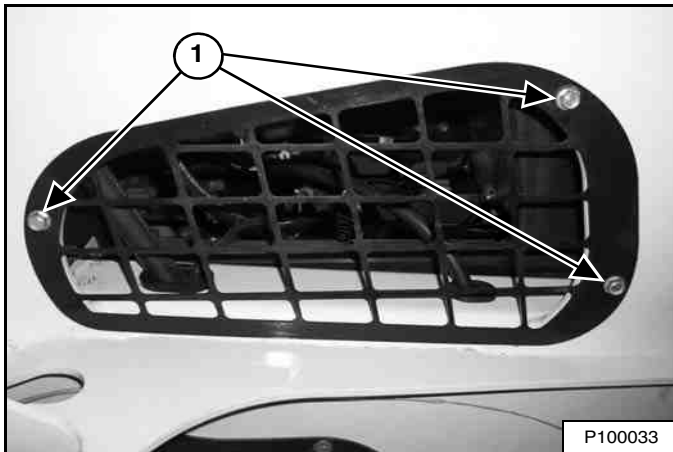

Remove the right side access cover bolts (Item 1) [Figure 245] and remove the access cover. (Lift arms shown raised for visual clarity.)

Figure 246



Put a suitable container below the filter, remove the filter (Item 1) [Figure 246], and clean the filter base.

Put clean oil on the new filter gasket, install the new filter, and tighten the filter to 37 – 45 N•m (27 – 33 ft-lb) torque.

Recycle or dispose of used fluid in an environmentally safe manner.

## WARNING

### AVOID INJURY OR DEATH

Always clean up spilled fuel or oil. Keep heat, flames, sparks or lighted tobacco away from fuel and oil. Failure to use care around combustibles can cause explosion or fire.

W-2103-0508

Install the right side access cover and bolts [Figure 245].

Start the engine and operate the loader hydraulic controls.

## WARNING

### AVOID INJURY OR DEATH

Diesel fuel or hydraulic fluid under pressure can penetrate skin or eyes, causing serious injury or death. Fluid leaks under pressure may not be visible. Use a piece of cardboard or wood to find leaks. Do not use your bare hand. Wear safety goggles. If fluid enters skin or eyes, get immediate medical attention from a doctor familiar with this injury.

W-2072-EN-0909

Stop the engine and check for leaks at the filter.

Check the fluid level in the reservoir and add as needed. (See Checking And Adding Fluid on Page 165.)

## HYDRAULIC / HYDROSTATIC SYSTEM (CONT'D)

### Replacing Reservoir Breather Cap

See the SERVICE SCHEDULE for the correct replacement interval. (See SERVICE SCHEDULE on Page 123.)

Stop the engine and remove the rear grille. (See REAR GRILLE on Page 137.)

**Figure 247**

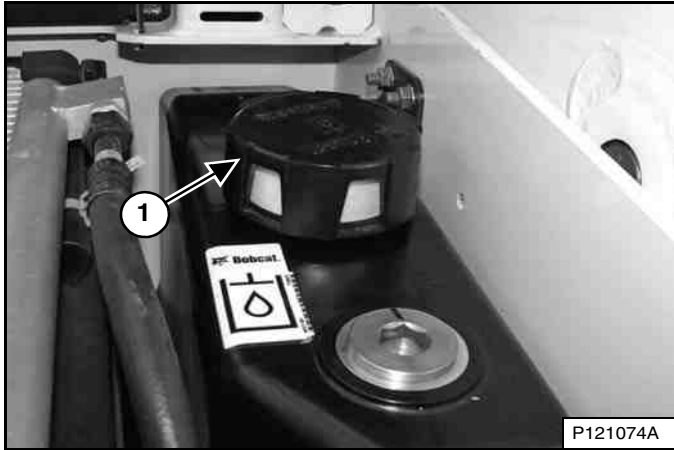

Remove the breather cap (Item 1) [Figure 247] and discard.

Install new breather cap.

Install the rear grille.

## TRACK TENSION

### Description

Figure 248



A bleed tool [Figure 248] is available and recommended to decrease track tension. The bleed tool will direct the flow of grease to aid in cleanup. See your Bobcat dealer to order a bleed tool.

The bleed tools are sized differently:

Part number 6675936 – Used for machines with two track tension fittings.

Part number 7277225 – Used for machines with one track tension fitting.

### Checking

Correct track tension is important for good performance and to prevent the tracks from derailing or wearing prematurely.

**NOTE: The wear of track rollers vary with the working conditions and different types of soil conditions.**

Park the loader on a level surface.

Figure 249

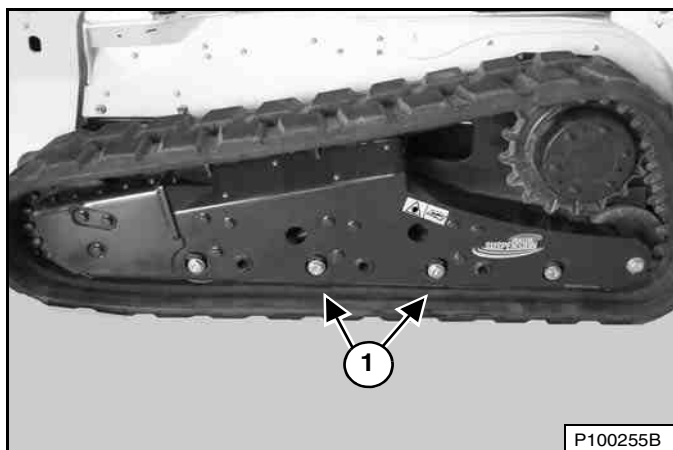

Raise one side of the loader and put jackstands at the front and rear of the loader frame so that the track is about 76 mm (3 in) off the ground [Figure 249]. Lower the loader to the jackstands. Be sure the jackstands do not touch the track.

Measure the track sag at either middle track roller (Item 1) [Figure 249]. The correct gap is 13 mm (1/2 in).

Figure 250

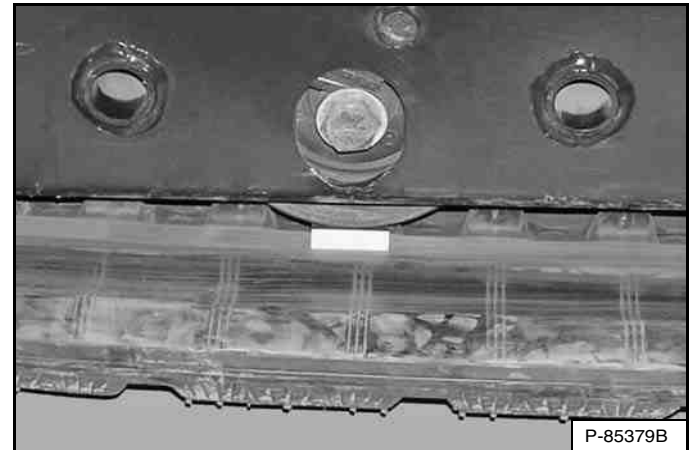
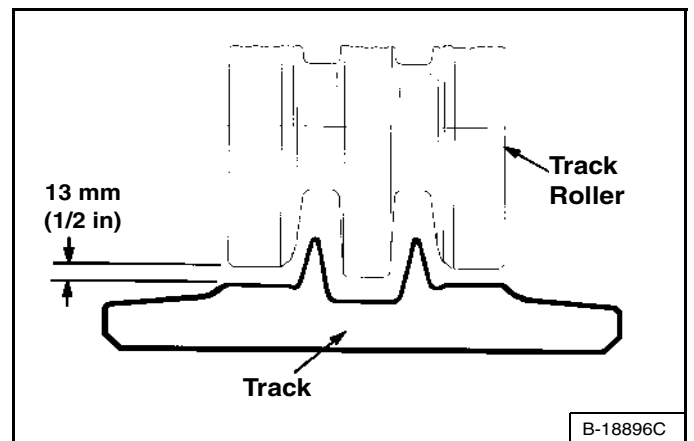

Figure 251



DO NOT put your fingers into the pinch points between the track and the roller. Use a 13 mm (1/2 in) bolt, dowel or block to check the gap [Figure 250] and [Figure 251].

**⚠ WARNING**

**AVOID INJURY**

Keep fingers and hands out of pinch points when checking the track tension.

W-2142-0903

## TRACK TENSION (CONT'D)

### Adjusting (Earlier Models With Two Track Tension Fittings)

Figure 252

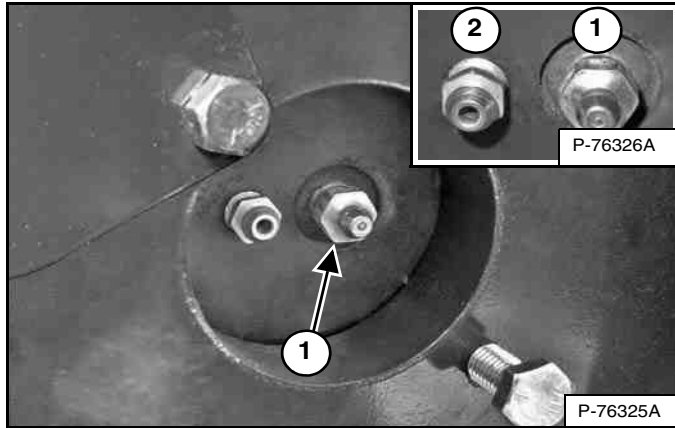

Loosen the access cover bolts and pivot the access cover open [Figure 252].

**NOTE:** Fittings may be oriented differently than shown. You **MUST** select the correct fitting for the task required. The grease fitting (Item 1) is used to add grease. The bleed fitting (Item 2) [Figure 252] is used to remove grease.

#### Increase Track Tension

Add grease to the grease fitting (Item 1) [Figure 252] until the track adjustment is correct [Figure 250] and [Figure 251].

**NOTE:** Do not remove grease fitting unless pressure is released using the bleed fitting. (See [Figure 253] on Page 172.)

**NOTE:** If replacement is necessary, always replace grease fitting (Item 1) [Figure 252] with genuine Bobcat Parts. The fitting is a special fitting designed for high pressure.

#### Decrease Track Tension

## WARNING

### HIGH PRESSURE GREASE CAN CAUSE SERIOUS INJURY

- Do not loosen grease fitting.
- Do not loosen bleed fitting more than 1 - 1/2 turns.

W-2781-0109

Pressure must be released from the grease cylinder to decrease track tension.

Figure 253

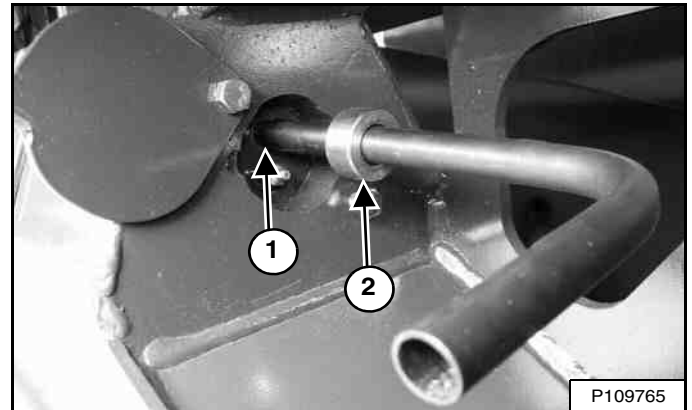

Install the bleed tool (6675936) on the bleed fitting (Item 1), adjust and tighten the collar (Item 2) [Figure 253] to fit behind the edge of the access cover.

Figure 254

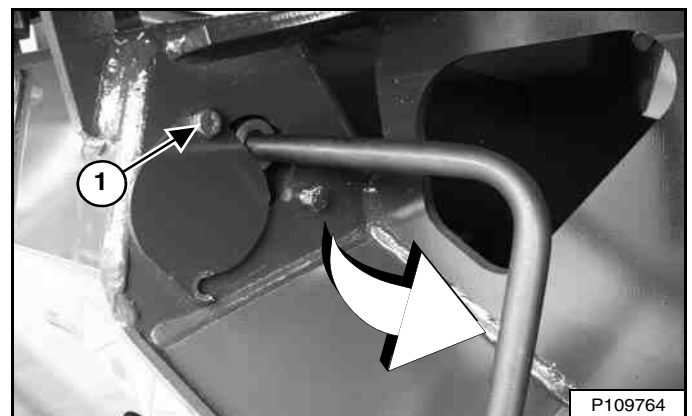

Tighten the access cover bolt (Item 1) [Figure 254] to secure the tool.

Turn the tool 90° anticlockwise and let the grease flow into a container. Release pressure [Figure 254] until the track adjustment is correct [Figure 250] and [Figure 251].

Tighten the bleed fitting. Pivot the access cover closed and tighten the access cover bolts.

Raise the loader. Remove the jackstands. Repeat the procedure for the other track. Dispose of grease in an environmentally safe manner.

**TRACK TENSION (CONT'D)**

**Adjusting (Later Models With One Track Tension Fitting)**

**Figure 255**

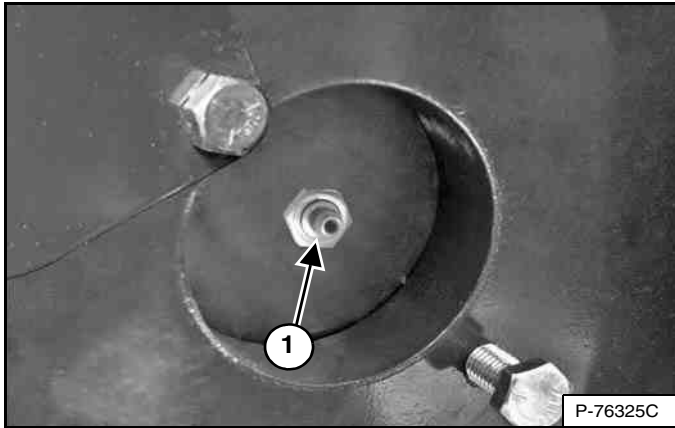

Loosen the access cover bolts and pivot the access cover open [Figure 255].

*Increase Track Tension*

Add grease to the track tension fitting (Item 1) [Figure 255] until the track adjustment is correct [Figure 250] and [Figure 251].

**NOTE:** Take care if using a pneumatic grease gun because high pressure can damage the grease fitting. Connect the pneumatic grease gun to a regulated air supply set at the lowest setting and slowly increase the air pressure until the grease fitting starts taking grease.

**NOTE:** Do not remove track tension fitting unless pressure is released. (See [Figure 256] on Page 173.)

**NOTE:** If replacement is necessary, always replace track tension fitting (Item 1) [Figure 255] with genuine Bobcat Parts. The fitting is a special fitting designed for high pressure.

*Decrease Track Tension*



**HIGH PRESSURE GREASE CAN CAUSE SERIOUS INJURY**

- Do not loosen the track tension fitting more than 1 - 1/2 turns.

W-2994-0515

Pressure must be released from the grease cylinder to decrease track tension.

**Figure 256**

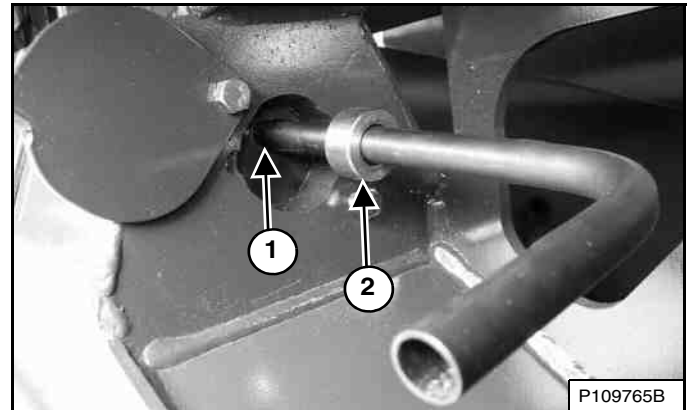

Install the bleed tool (7277225) on the track tension fitting (Item 1), adjust and tighten the collar (Item 2) [Figure 256] to fit behind the edge of the access cover.

**Figure 257**

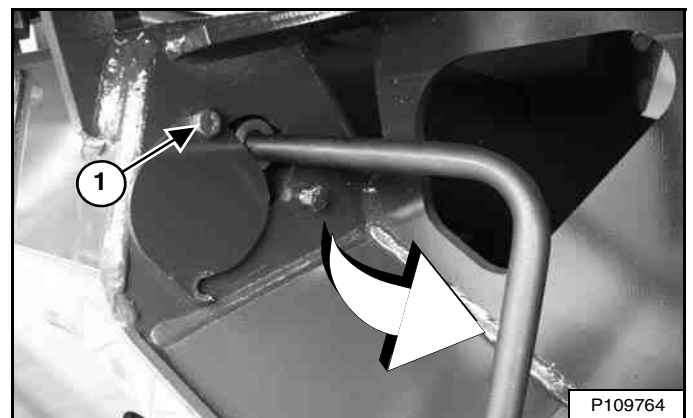

Tighten the access cover bolt (Item 1) [Figure 257] to secure the tool.

Turn the tool 90° anticlockwise and let the grease flow into a container. Release pressure [Figure 257] until the track adjustment is correct [Figure 250] and [Figure 251].

Tighten the track tension fitting to 24 – 30 N•m (18 – 22 ft-lb) torque. Pivot the access cover closed and tighten the access cover bolts.

Raise the loader. Remove the jackstands. Repeat the procedure for the other track. Dispose of grease in an environmentally safe manner.

## HYDROSTATIC DRIVE MOTOR

### Removing And Replacing Oil

See the SERVICE SCHEDULE for the correct service interval. (See SERVICE SCHEDULE on Page 123.)

Park the loader so that the plug in the hydrostatic drive motor is at the bottom.

Remove the plug and let the oil drain from the hydrostatic drive motor.

Figure 258

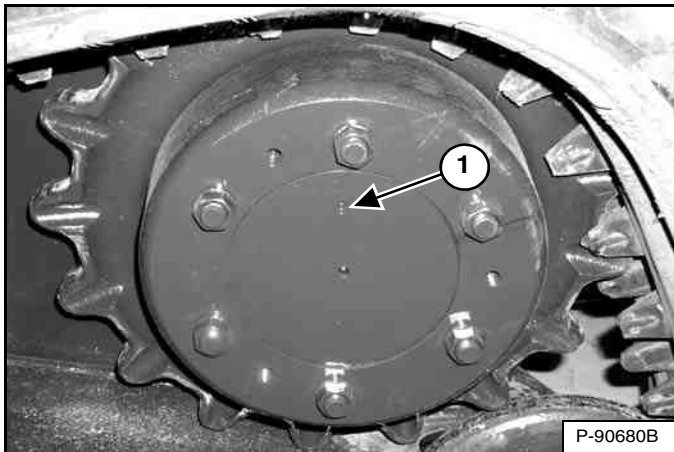

Rotate the hydrostatic drive motor so that the plug (Item 1) [Figure 258] is at the top. Add high performance synthetic oil (P/N 7024981). (See Capacities on Page 217.)

Clean the threads of the plug and drain hole. Apply Loctite® 243 to the plug threads. Install and tighten the plug.

Repeat for the other hydrostatic drive motor.

Recycle or dispose of the used oil in an environmentally safe manner.

## TRACK SPROCKET MAINTENANCE

### Tightening Procedure

See the SERVICE SCHEDULE for the correct service interval. (See SERVICE SCHEDULE on Page 123.)

Figure 259

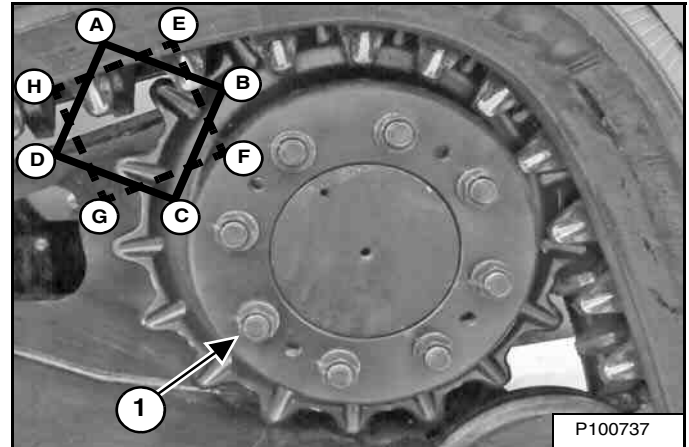

Check the torque of the eight track sprocket nuts (Item 1) [Figure 259]. Use a cross-pattern tightening sequence (A-B-C-D, E-F-G-H) and then repeat to tighten the nuts to 492 – 544 N•m (363 – 401 ft-lb) torque.



## ALTERNATOR BELT

### Belt Adjustment

The alternator belt is a special maintenance free type that is pretensioned over the pulleys. This belt eliminates the need for a tensioning device and does not require periodic adjustment. Contact your Bobcat dealer for replacement parts.

### Belt Replacement

Stop the engine and open the rear door.

**Figure 260**

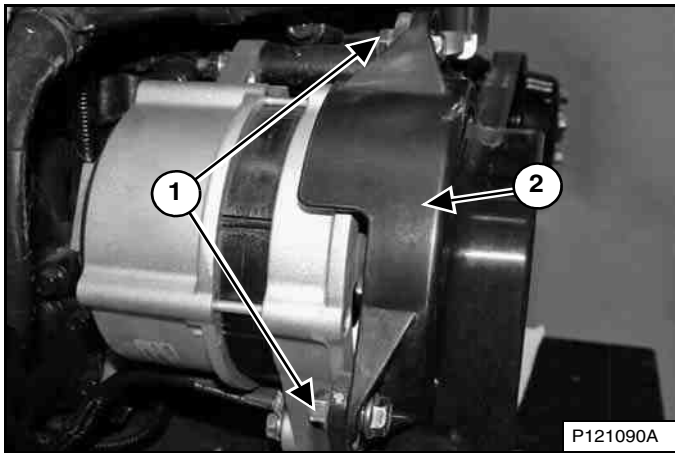

Remove the alternator belt shield mounting nuts and bolts (Item 1) [Figure 260].

Remove the alternator belt shield (Item 2) [Figure 260].

**Figure 261**

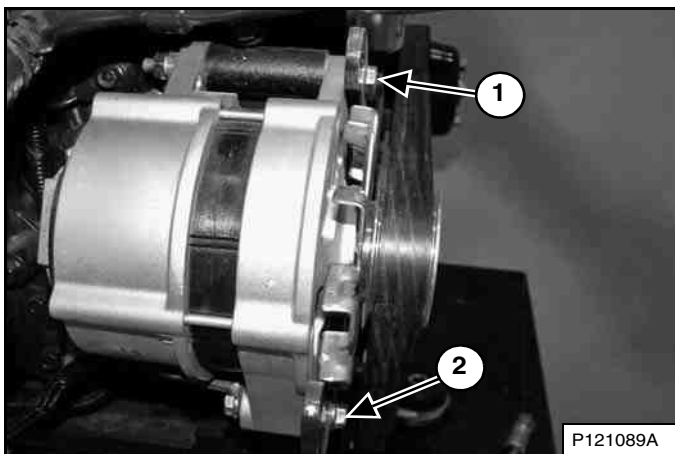

Remove the bottom alternator mounting bolt (Item 2). Loosen the top alternator mounting bolt (Item 1) [Figure 261].

Move the alternator toward the engine fully and remove the belt from the pulleys.

Inspect the pulleys for wear.

Install new belt.

**Figure 262**

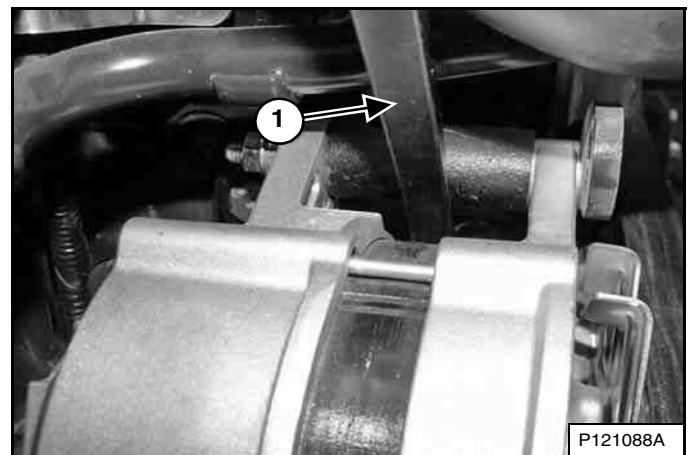

Use a prybar (Item 1) [Figure 262] in the location shown to move the alternator until the bottom alternator mounting bolt (Item 2) [Figure 261] can be installed.

Tighten the top alternator mounting bolt and the bottom alternator mounting bolt [Figure 261].

Install the alternator belt shield, mounting bolts, and nuts [Figure 260].

Close the rear door.

## AIR CONDITIONING BELT

This machine may be equipped with air conditioning.

### Belt Adjustment

The air conditioning belt has a spring loaded idler that constantly maintains the correct belt tension. This belt does not require periodic adjustment.

### Belt Replacement

Stop the engine and open the rear door.

**Figure 263**

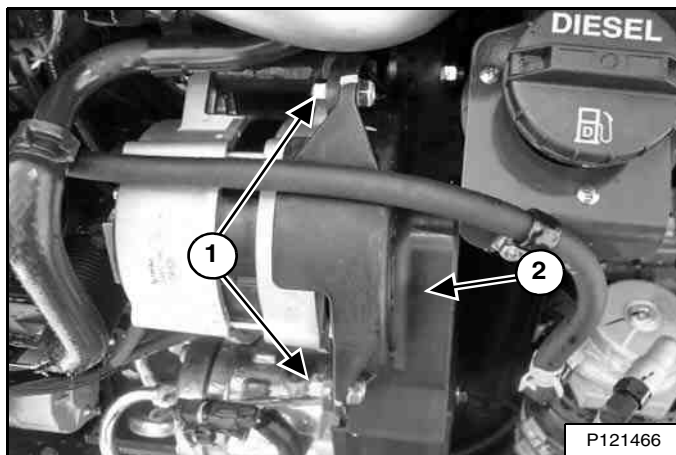

Remove the alternator belt shield mounting nuts and bolts (Item 1) [Figure 263].

Remove the alternator belt shield (Item 2) [Figure 263].

**Figure 264**

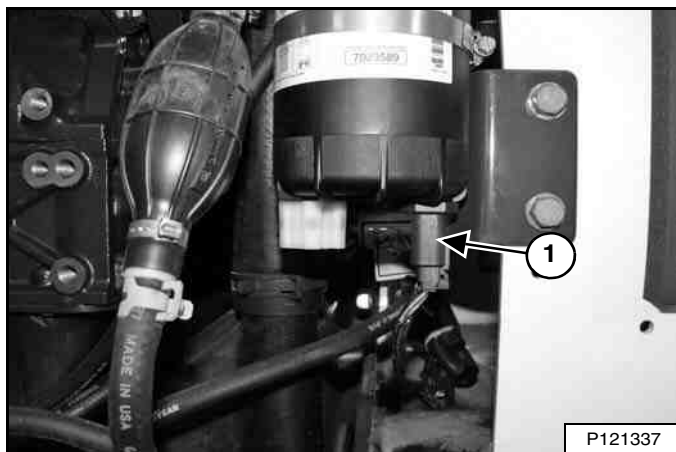

Disconnect the electrical connector (Item 1) [Figure 264] from the fuel filter.

**Figure 265**

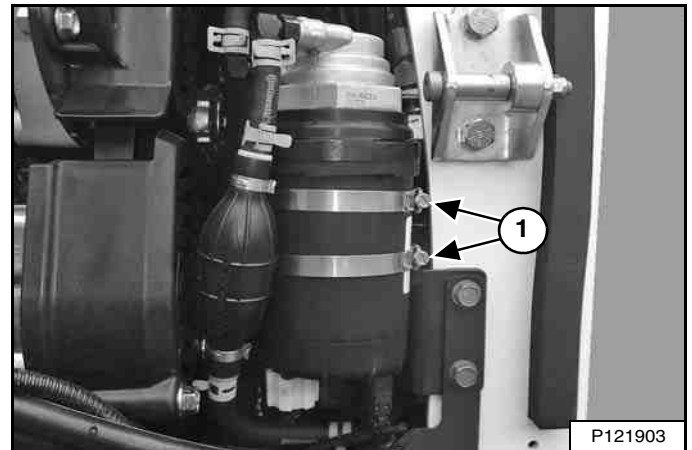

Loosen the fuel filter clamps (Item 1) [Figure 265].

Remove the fuel filter assembly from the clamps and move clear of the air conditioning compressor belt shield.

## AIR CONDITIONING BELT (CONT'D)

### Belt Replacement (Cont'd)

Figure 266

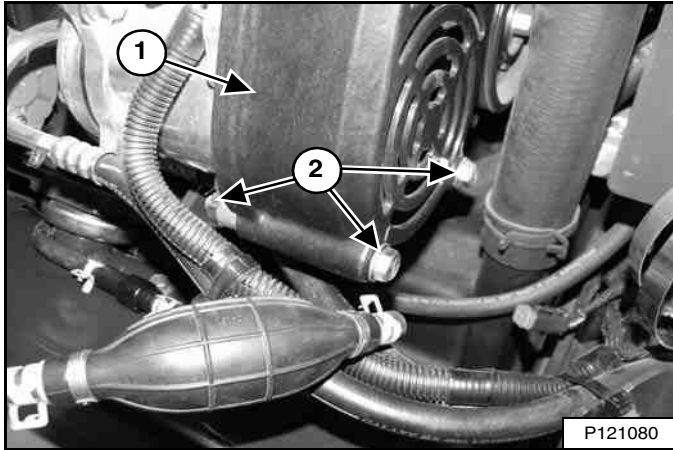

Remove the air conditioning compressor belt shield mounting bolts and nut (Item 2) [Figure 266].

Remove the air conditioning compressor belt shield (Item 1) [Figure 266].

Figure 267

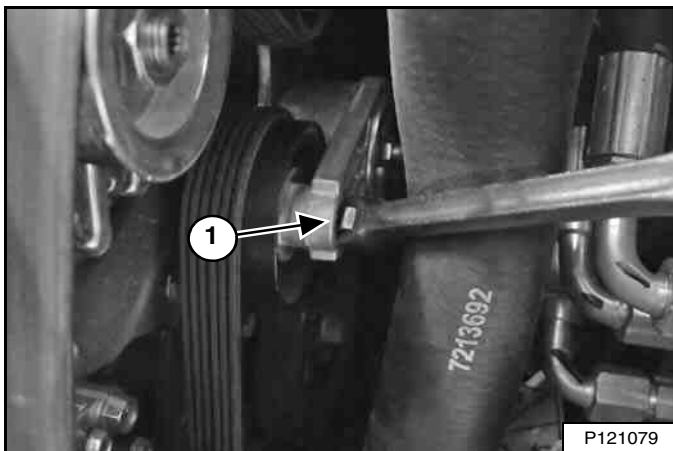

Insert breaker bar into the hole provided in the idler pulley (Item 1) [Figure 267] and push down to release belt tension. Remove the belt from the pulleys.

Inspect the pulleys for wear.

Figure 268

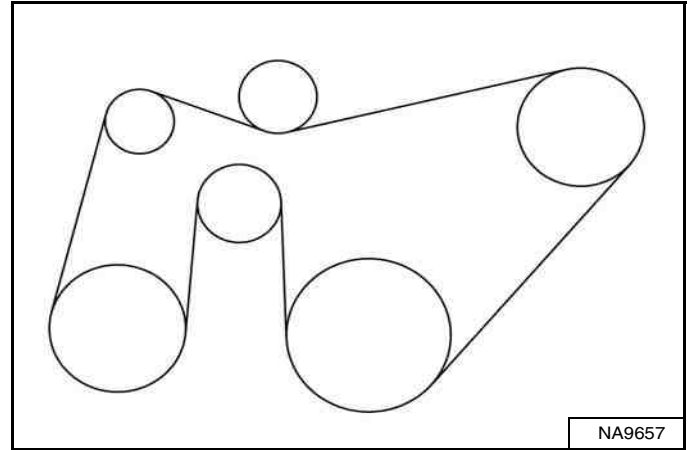

Install new belt using the routing diagram [Figure 268] and remove breaker bar.

**NOTE: Verify the belt is properly aligned on each pulley.**

Install air conditioning compressor belt shield and mounting bolts and nut [Figure 266].

Install fuel filter assembly into clamps and tighten clamps [Figure 265].

Connect the electrical connector (Item 1) [Figure 264] to the fuel filter.

Install the alternator belt shield, mounting bolts, and nuts [Figure 263].

Close the rear door.

## DRIVE BELT

### Belt Adjustment

The drive belt does not need adjustment. The belt has a spring loaded idler that constantly maintains the correct belt tension. The spring loaded idler stop adjustment, detailed below, is critical for long belt life.

### Stop Adjustment

See the SERVICE SCHEDULE for the correct service interval. (See SERVICE SCHEDULE on Page 123.)

Stop the engine and open the rear door.

**Figure 269**

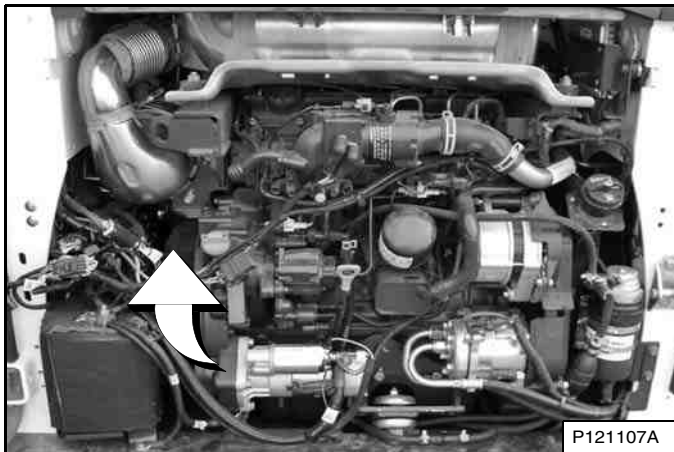

The spring loaded idler is located above the battery on the left side of the engine [Figure 269].

**Figure 270**

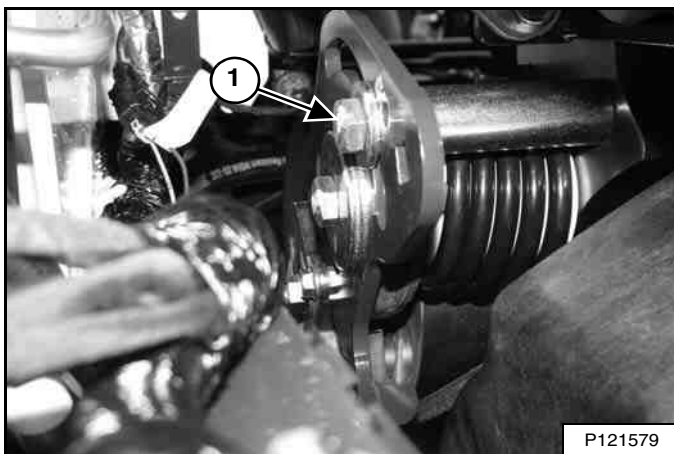

Loosen the spring loaded idler adjustment bolt (Item 1) [Figure 270].

**Figure 271**

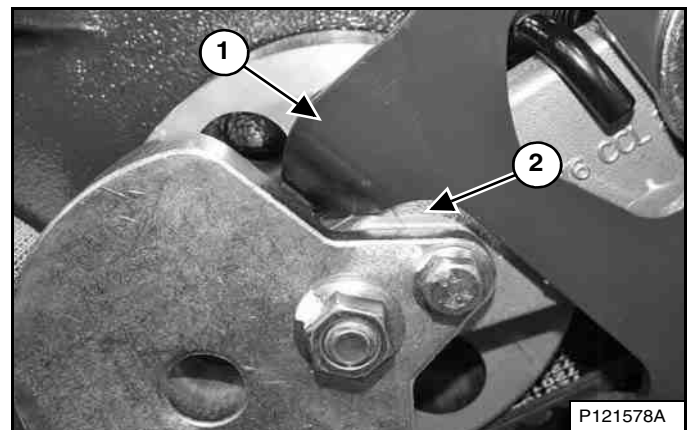

Allow the stop arm (Item 1) to contact the top of the spring loaded idler (Item 2) [Figure 271].

Tighten the spring loaded idler adjustment bolt (Item 1) [Figure 270] to 105 – 115 N•m (78 – 85 ft-lb) torque.

## DRIVE BELT (CONT'D)

### Belt Replacement

Stop the engine and open the rear door.

Remove the battery. (See Removing And Installing Battery on Page 164.)

**Figure 272**

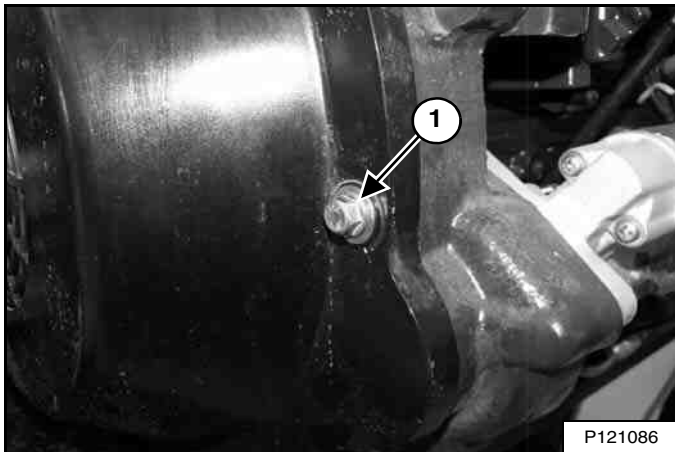

Remove the drive belt shield bolt (Item 1) [Figure 272].

**Figure 273**

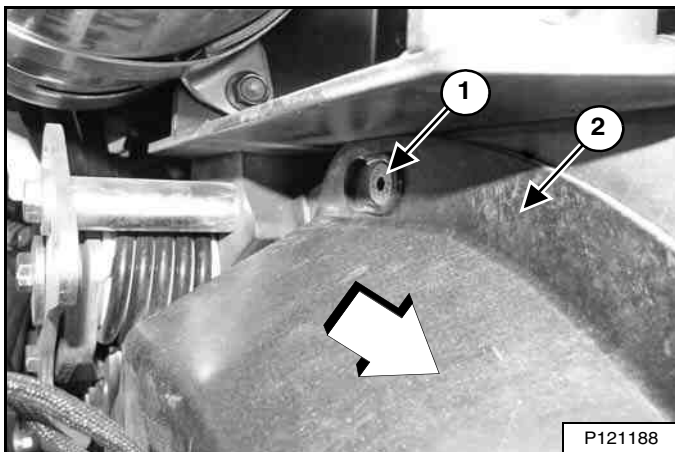

Do **NOT** loosen the drive belt shield mounting bolts (top bolt shown) (Item 1). Slide the drive belt shield (Item 2) [Figure 273] toward the back of the loader to unseat the shield from the top and bottom drive belt shield mounting bolts.

Remove the drive belt shield (Item 2) [Figure 273].

**Figure 274**

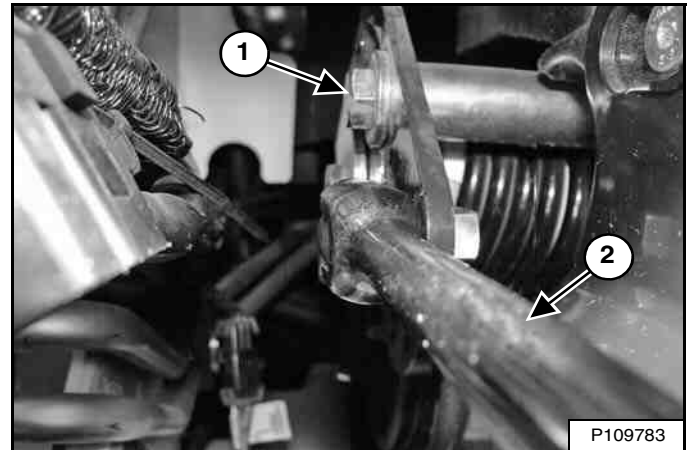

Loosen the spring loaded idler adjustment bolt (Item 1). Insert a breaker bar (Item 2) [Figure 274] into the slot provided in the stop arm as shown and push the breaker bar down to release tension on the drive belt.

Tighten the adjustment bolt (Item 1) [Figure 274] to hold the spring loaded idler off the drive belt.

Remove the drive belt from the hydrostatic pump pulley and flywheel pulley. Inspect the pulleys for wear.

Install new drive belt.

Loosen the spring loaded idler adjustment bolt (Item 1) [Figure 274] and allow the idler to contact the drive belt.

Continue the procedure on the next page.

DRIVE BELT (CONT'D)

Belt Replacement (Cont'd)

Figure 275

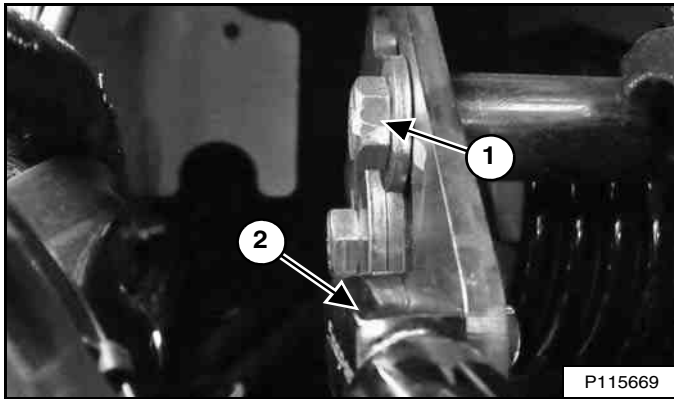

Adjust a torque wrench for 54,2 N•m (40 ft-lb). Insert the torque wrench (Item 2) [Figure 275] into the slot provided in the stop arm as shown and move the torque wrench up until the correct torque is indicated.

Maintain torque on the stop arm and tighten the spring loaded idler adjustment bolt (Item 1) [Figure 275] to 105 – 115 N•m (78 – 85 ft-lb) torque.

**NOTE: This procedure is required to preload a new drive belt in order to achieve the correct stop adjustment after the initial belt break-in period.**

Figure 276

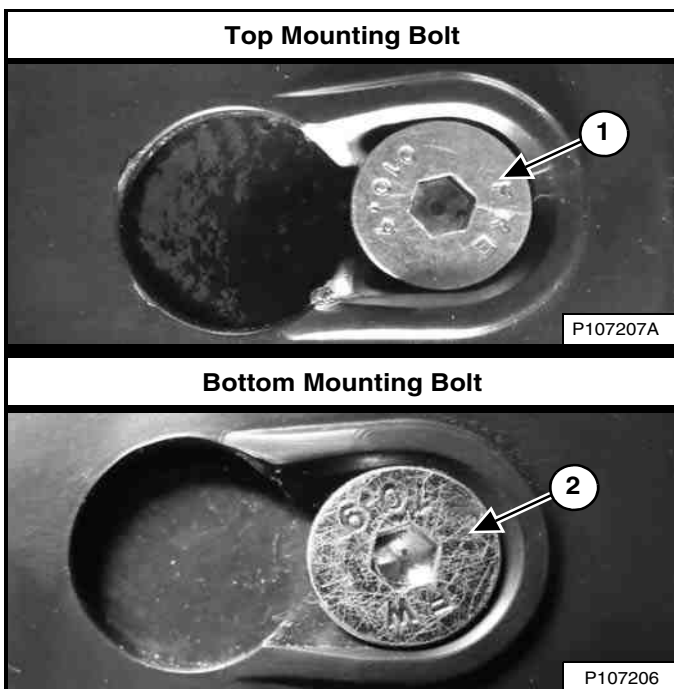

Position the drive belt shield over the drive belt shield mounting bolts. Slide the drive belt shield toward the front of the loader to fully seat the shield onto the top and bottom mounting bolts (Items 1 and 2) [Figure 276].

Figure 277

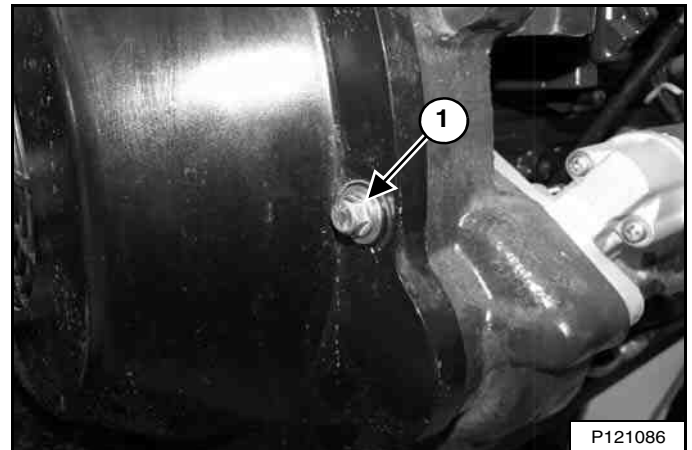

Install the drive belt shield bolt (Item 1) [Figure 277].

Install the battery. (See Removing And Installing Battery on Page 164.)

Close the rear door.

**NOTE: The stop arm MUST be adjusted after 50 hours operation with the new drive belt. (See Stop Adjustment on Page 178.)**

**See the SERVICE SCHEDULE for the correct service interval after the initial 50 hour adjustment. (See SERVICE SCHEDULE on Page 123.)**



## AUTOMATIC RIDE CONTROL ACCUMULATOR

### Checking Accumulator Charge

This machine may be equipped with Automatic Ride Control.

The nitrogen charge in your accumulator will decrease over time. This will result in decreased effectiveness of the automatic ride control benefits.

**NOTE: The signs of a low accumulator charge include: excessive lift arm movement, reduced ride control performance, or loss of ride control function.**

Special tools and equipment are required to check and service the nitrogen charge in the accumulator.



**RIDE CONTROL ACCUMULATOR INSTALLED  
PRESSURISED FLUID CAN CAUSE SERIOUS INJURY**  
After fully lowering the lift arms or installing an approved lift arm support device, use lift arm bypass control for 5 seconds to release pressure from lift circuit before servicing.

See Operation & Maintenance Manual or Service Manual for lift arm bypass control instructions.

W-3015-EN-0816

See your Bobcat dealer for service if you believe that your automatic ride control accumulator charge is low.

## LUBRICATING THE LOADER

### Lubrication Locations

See the SERVICE SCHEDULE for the correct service interval. (See SERVICE SCHEDULE on Page 123.)

Record the operating hours each time you lubricate the Bobcat loader.

Always use a good quality lithium based multipurpose grease when you lubricate the loader. Apply the lubricant until extra grease shows.

Remove attachment from the loader. (See Installing And Removing The Attachment (Hand Lever Bob-Tach) on Page 106.) **OR** (See Installing And Removing The Attachment (Power Bob-Tach) on Page 109.)

Stop the engine.

**Figure 278**

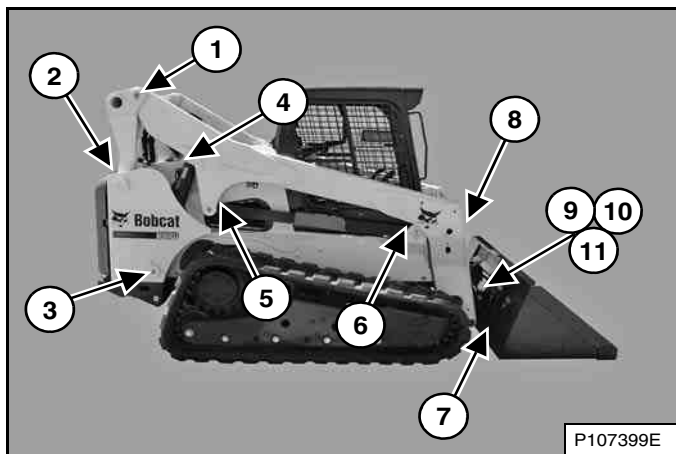

The grease fitting locations [Figure 278] are shown in more detail in the following figures.

Lubricate the following:

**Figure 279**

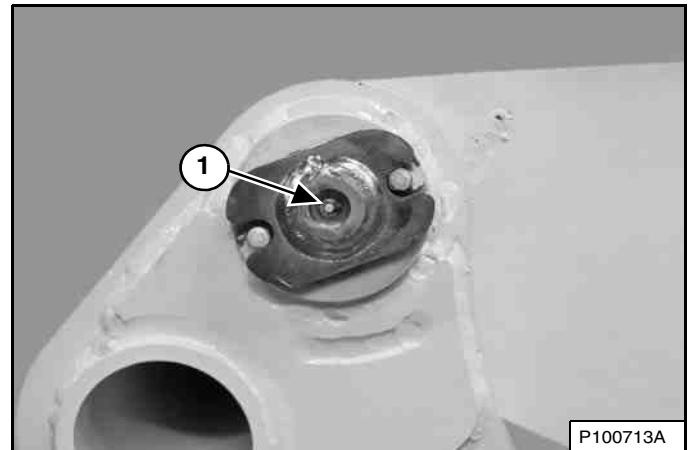

1. Lift Arm Pivot Pin (Both Sides) (2) [Figure 279].

**Figure 280**

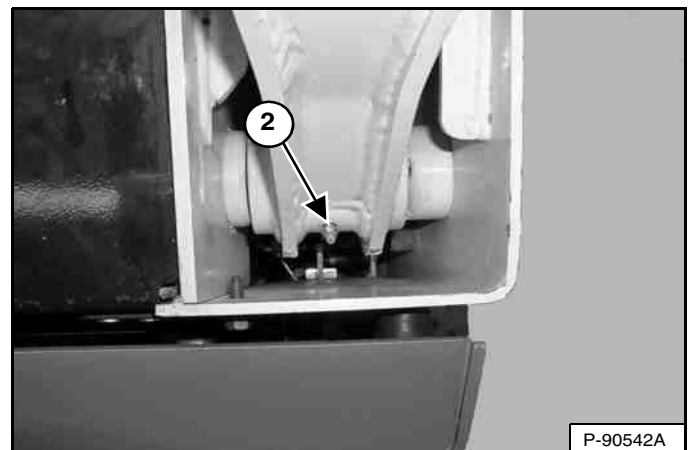

2. Lift Arm Link Pivot (Both Sides) (2) [Figure 280].



**LUBRICATING THE LOADER (CONT'D)**

**Lubrication Locations (Cont'd)**

**Figure 281**

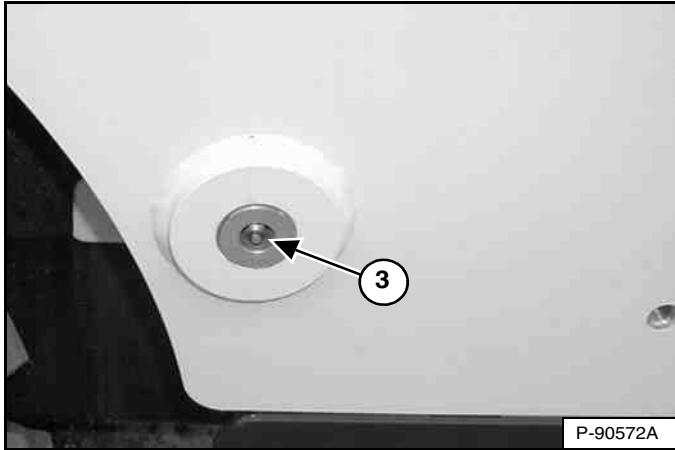

3. Base End Lift Cylinder (Both Sides) (2) [Figure 281].

**Figure 282**

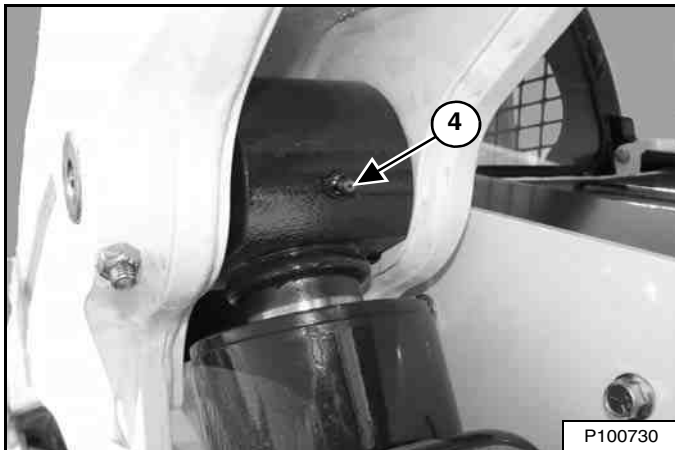

4. Rod End Lift Cylinder (Both Sides) (2) [Figure 282].

**Figure 283**

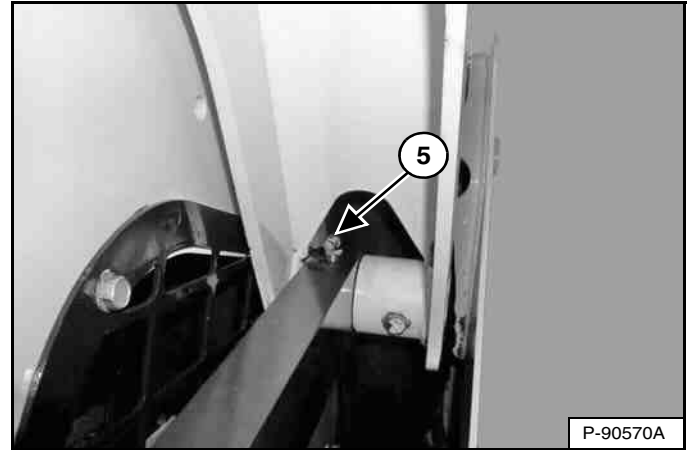

5. Rear Control Link (Both Sides) (2) [Figure 283].

**Figure 284**

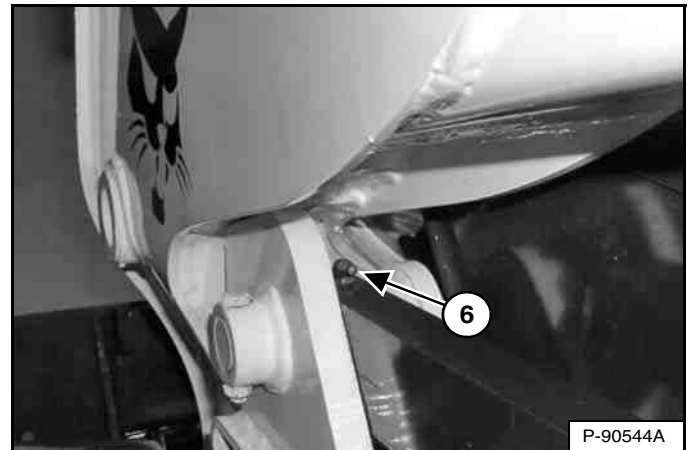

6. Front Control Link (Both Sides) (2) [Figure 284].

LUBRICATING THE LOADER (CONT'D)

Lubrication Locations (Cont'd)

Figure 285

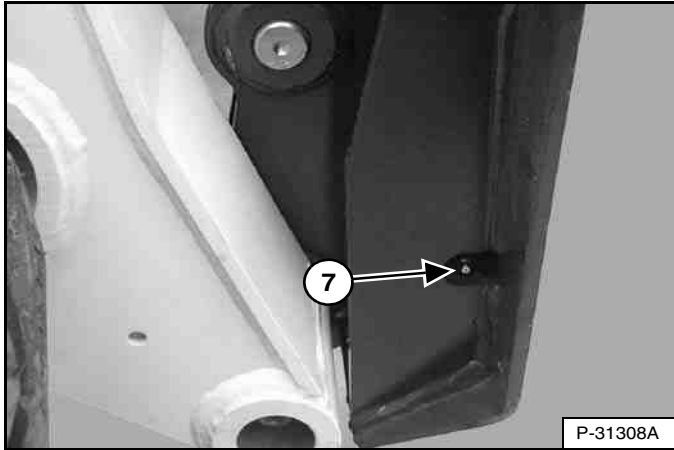

7. Bob-Tach Wedge (Both Sides) (2) [Figure 285].

Figure 286

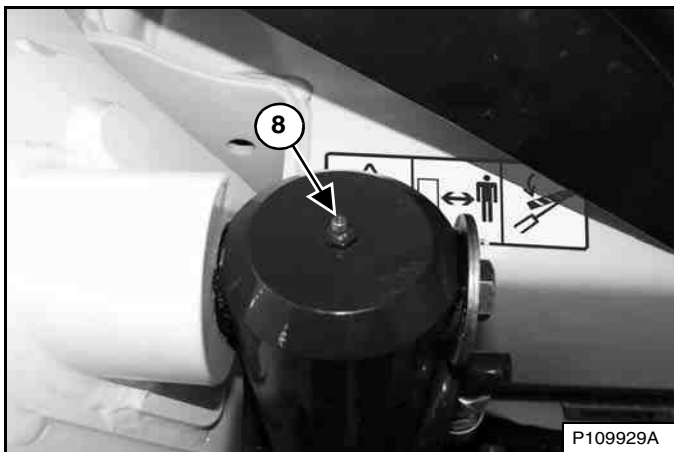

8. Base End Tilt Cylinder (Both Sides) (2) [Figure 286].

Figure 287

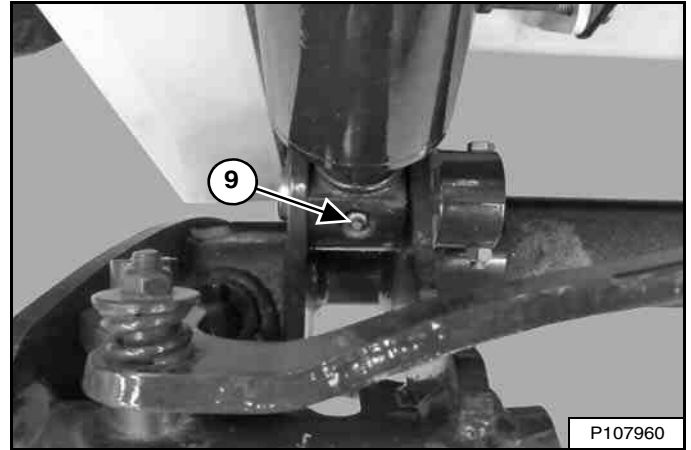

9. Rod End Tilt Cylinder (Both Sides) (2) [Figure 287].

Figure 288

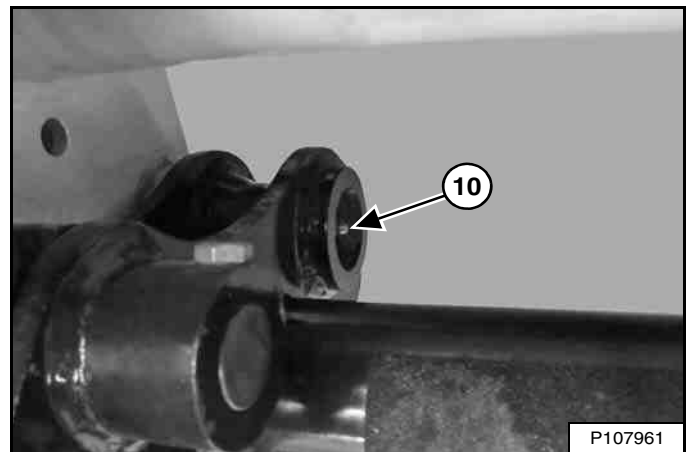

10. Bob-Tach Pivot Pin (Both Sides) (2) [Figure 288].

## LUBRICATING THE LOADER (CONT'D)

### Lubrication Locations (Cont'd)

Figure 289

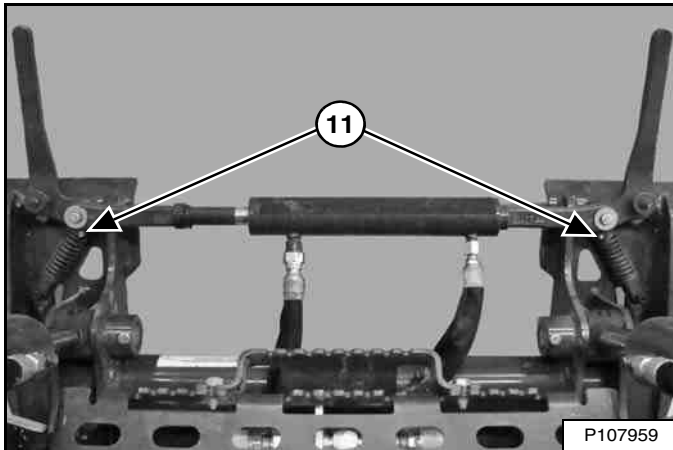

11. Power Bob-Tach Hydraulic Cylinder (if equipped) (2)  
[Figure 289].

## TRACK ROLLER AND IDLER LUBRICATION

### Procedure

The track rollers and idlers have sealed bearings and do not require lubrication.

## PIVOT PINS

### Inspection And Maintenance

Figure 290

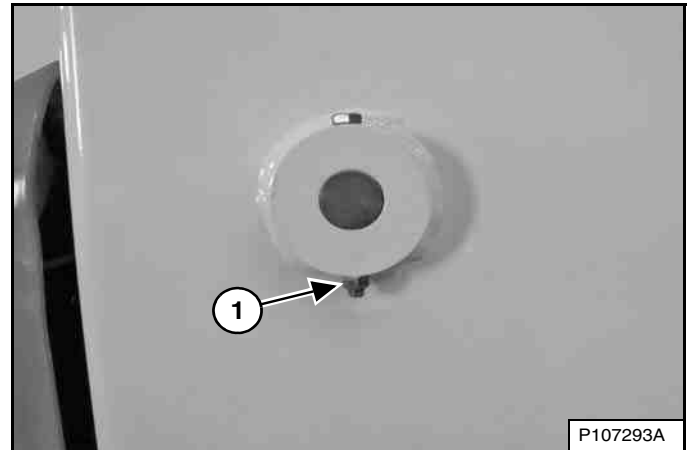

All lift arm and cylinder pivots have a large pin held in position with a retainer bolt and locknut (Item 1) [Figure 290].

Check that the locknuts are tightened to 48 – 54 N•m (35 – 40 ft-lb) torque.

**BOB-TACH (HAND LEVER)**

**Inspection And Maintenance**

**Figure 291**

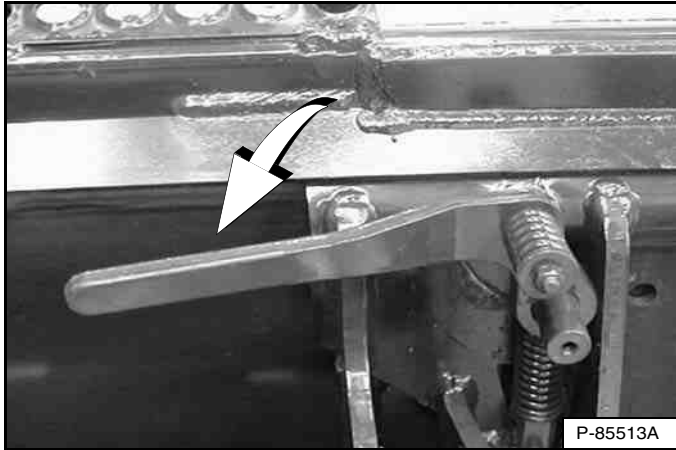

Move the Bob-Tach levers down to engage the wedges [Figure 291].

The levers and wedges must move freely.

**! WARNING**

**AVOID INJURY OR DEATH**

The Bob-Tach wedges must extend through the holes in the attachment mounting frame. Levers must be fully down and locked. Failure to secure wedges can allow attachment to come off.

W-2715-0208

**Figure 292**

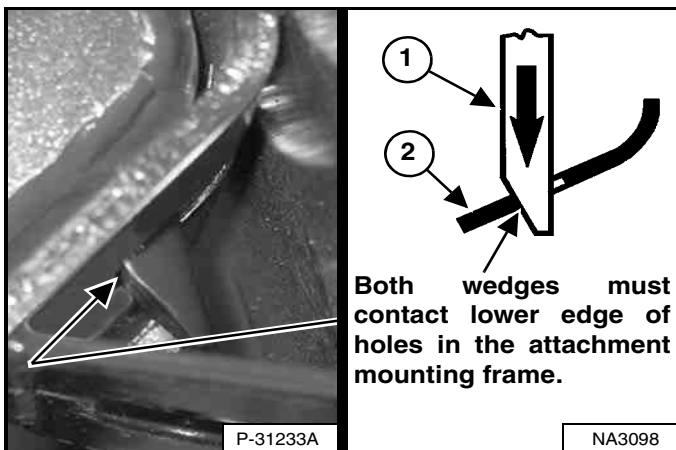

The wedges (Item 1) [Figure 292] must extend through the holes in the attachment mounting frame.

The spring loaded wedges (Item 1) must contact the lower edge of the holes in the attachment mounting frame (Item 2) [Figure 292].

If the wedges do not contact the lower edge of the holes [Figure 292], the attachment will be loose and can come off the Bob-Tach.

**Figure 293**

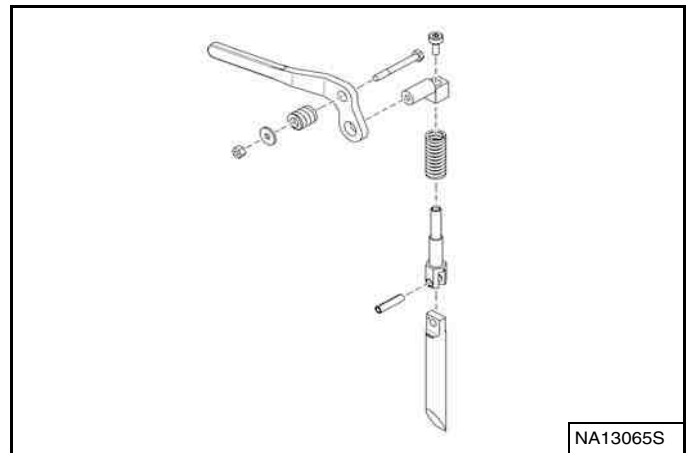

Inspect the mounting frame on the attachment and Bob-Tach, linkages, and wedges for excessive wear or damage [Figure 293]. Replace any parts that are damaged, bent, or missing. Keep all fasteners tight.

Look for cracked welds. Contact your Bobcat dealer for repair or replacement parts.

Lubricate the wedges. (See SERVICE SCHEDULE on Page 123.) and (See LUBRICATING THE LOADER on Page 182.)

## BOB-TACH (POWER)

This machine may be equipped with a Power Bob-Tach.

### Inspection And Maintenance

**Figure 294**

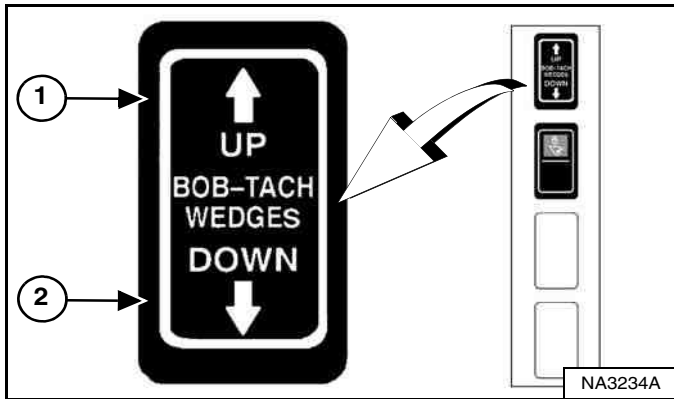

Push and hold the BOB-TACH WEDGES “UP” switch (Item 1) until wedges are fully raised. Push and hold the BOB-TACH WEDGES “DOWN” switch (Item 2) [Figure 294] until the wedges are fully down.

The levers and wedges must move freely.



### AVOID INJURY OR DEATH

The Bob-Tach wedges must extend through the holes in the attachment mounting frame. Levers must be fully down and locked. Failure to secure wedges can allow attachment to come off.

W-2715-0208

**Figure 295**

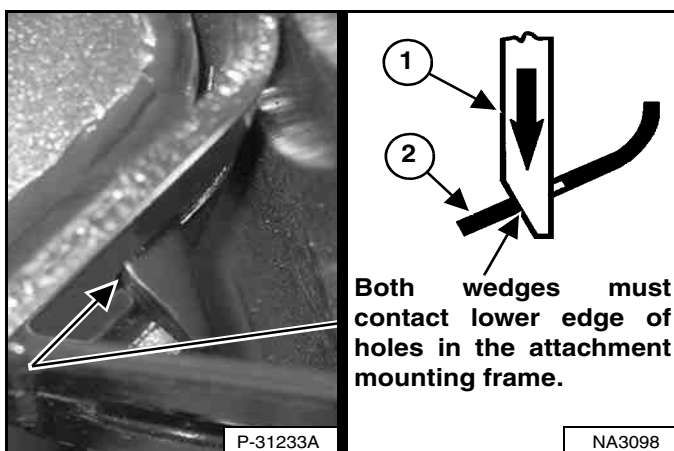

The wedges (Item 1) [Figure 295] must extend through the holes in the attachment mounting frame.

The spring loaded wedges (Item 1) must contact the lower edge of the holes in the attachment mounting frame (Item 2) [Figure 295].

If the wedges do not contact the lower edge of the holes [Figure 295], the attachment will be loose and can come off the Bob-Tach.

**Figure 296**

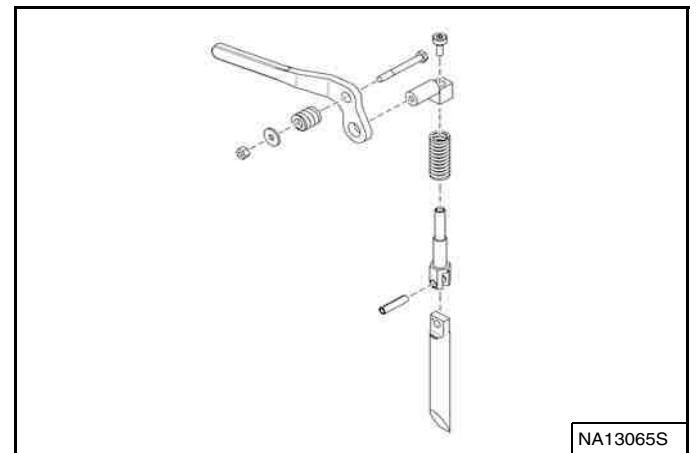

Inspect the mounting frame on the attachment and Bob-Tach, linkages, and wedges for excessive wear or damage [Figure 296]. Replace any parts that are damaged, bent, or missing. Keep all fasteners tight.

Look for cracked welds. Contact your Bobcat dealer for repair or replacement parts.

Lubricate the wedges. (See SERVICE SCHEDULE on Page 123.) and (See LUBRICATING THE LOADER on Page 182.)



## LOADER STORAGE AND RETURN TO SERVICE

### Storage

You may decide to store your Bobcat loader for an extended period of time. Perform the procedures below for storage:

- Thoroughly clean the loader including the engine compartment.
- Lubricate the loader.
- Replace worn or damaged parts.
- Park the loader in a dry protected shelter.
- Lower the lift arms all the way and put the bucket flat on the ground.
- Put blocks under the frame to remove weight from the tracks.
- Put grease on any exposed cylinder rods.
- Put fuel stabiliser into the fuel tank and operate the engine a few minutes to circulate the stabiliser to the pump and fuel injectors.

*If biodiesel blend fuel has been used, perform the following:*

Drain the fuel tank, refill with 100% petroleum diesel fuel, add fuel stabiliser, and operate the engine for at least 30 minutes.

- Drain and flush the cooling system. Refill with premixed coolant.
- Replace all fluids and filters (engine, hydraulic / hydrostatic).
- Replace air cleaner, heater, and air conditioning filters.
- Put all controls into the NEUTRAL position.
- Remove the battery. Be sure the electrolyte level is correct, then charge the battery. Store the battery in a cool dry location above freezing temperatures and charge the battery periodically during storage.
- Cover the exhaust pipe opening.
- Tag the machine to indicate that the machine is in storage condition.

### Return To Service

After the Bobcat loader has been in storage, perform the procedures below to return the loader to service:

- Check the engine oil and hydraulic fluid levels; check coolant level.
- Install a fully charged battery.
- Remove grease from exposed cylinder rods.
- Check all belt tensions.
- Be sure all shields and guards are in position.
- Lubricate the loader.
- Check track condition and remove blocks from under frame.
- Remove cover from exhaust pipe opening.
- Start the engine and operate for a few minutes while observing the instrument panels and systems for correct operation.
- Operate machine, check for correct function.
- Stop the engine and check for leaks. Repair as needed.



## SYSTEM SETUP AND ANALYSIS

DIAGNOSTIC SERVICE CODES .....	190
Viewing Service Codes .....	190
Service Codes List .....	191
CONTROL PANEL SETUP .....	205
Right Panel Setup (Deluxe Instrumentation Panel) .....	205
PASSWORD SETUP (KEYLESS START PANEL) .....	208
Password Description .....	208
Changing The Owner Password .....	208
Password Lockout Feature .....	208
PASSWORD SETUP (DELUXE INSTRUMENTATION PANEL) .....	209
Password Description .....	209
Changing The Owner Password .....	209
Changing The User Passwords .....	210
Password Lockout Feature .....	210
MAINTENANCE CLOCK .....	211
Description .....	211
Setup .....	211
Reset .....	211

## DIAGNOSTIC SERVICE CODES

### Viewing Service Codes

The Service Codes will aid your dealer in diagnosing conditions that can damage your machine.

#### Left Panel

Figure 297



Press the Information button (Item 2) to cycle the data display (Item 1) [Figure 297] until the service code screen is displayed. If more than one service code is present, the codes will scroll on the data display.

When no service code is present, [NONE] is displayed [Figure 297].

**NOTE:** Corroded or loose earths can cause multiple service codes and / or abnormal symptoms. All instrument panel lights flashing, alarm sounding, headlights and taillights flashing, can indicate a bad earth. The same symptoms can apply if the voltage is low, such as loose or corroded battery cables. If you observe these symptoms, check earths and positive leads first.

#### Deluxe Instrumentation Panel

The optional Deluxe Instrumentation Panel offers an additional view of service codes that includes a brief description.

The last 40 codes stored in history can also be viewed using the Deluxe Instrumentation Panel.

	<p>Press a scroll button (Item 1) repeatedly until the Active Warnings screen icon (Inset) is highlighted.</p>
	<p>The ACTIVE WARNINGS screen displays active service codes. Press [9] to view the next service code if more than one is present. Press [4] to display a history of service codes.</p>
	<p>The WARNINGS HISTORY screen will list the Service Code Number (CODE), Hourmeter reading when the error occurred (HOUR), and the User (USER) who was logged in to operate the machine when the error occurred.</p>
<p>Press [9] to view the next eight service codes.</p> <p>A total of 40 codes can be stored. When more than 40 codes occur, the oldest code will disappear and the newest code will be in the number 1 position.</p>	
	<p>Press the list number next to the service code for more detail.</p> <p>Press the left scroll button to back up one screen.</p>



**DIAGNOSTIC SERVICE CODES (CONT'D)**

**Service Codes List**

**Figure 298**

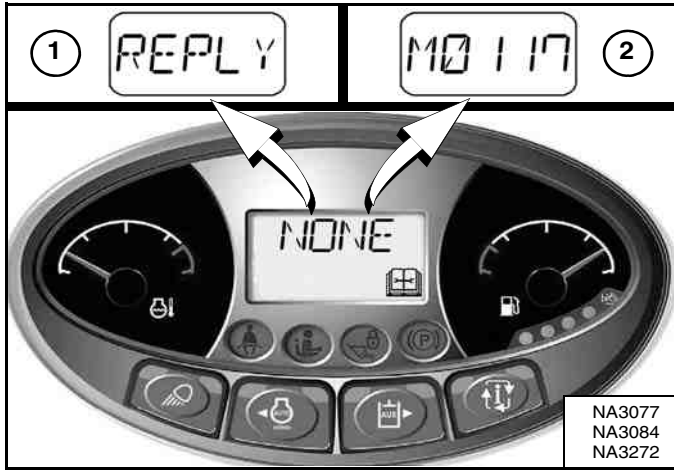

Service codes can be either letters (Item 1) or numbers (Item 2) [Figure 298].

The following letter codes may be displayed:

CODE	DESCRIPTION
CODE	The controller is asking for a password. (Keyless Start and Deluxe Instrumentation Panels only.)
COLD	The engine controller has determined the engine must warm up. (See Cold Temperature Engine Speed Control on Page 101.)
DESOX	The engine is performing a DeSOX process. Operate the machine under load. (See SELECTIVE CATALYTIC REDUCTION (SCR) SYSTEM on Page 53.)
DOOR	Operator cab door is open. (Lift and Tilt functions will not operate.)
ERROR	The wrong password was entered. (Keyless Start and Deluxe Instrumentation Panels only.)
REPLY	One or both instrument panel(s) not communicating with the controller.
RFOFF	Reversing fan is disabled. (See Reversing Fan on Page 81.)
SHTDN	A shutdown condition exists.

CODE	DESCRIPTION	CODE	DESCRIPTION
A0618	Wheel speed out of range	A8205	ACD output 'C' short to battery
A3623	ACD not programmed	A8206	ACD output 'C' short to earth
A4621	5 volt sensor supply out of range high	A8207	ACD output 'C' open circuit
A4622	5 volt sensor supply out of range low	A8232	ACD output 'C' overcurrent
A4721	8 volt sensor supply out of range high	A8302	ACD output 'D' error ON
A4722	8 volt sensor supply out of range low	A8303	ACD output 'D' error OFF
A7701	Machine key active	A8305	ACD output 'D' short to battery
A7901	E-Stop active	A8306	ACD output 'D' short to earth
A8002	ACD output 'A' error ON	A8307	ACD output 'D' open circuit
A8003	ACD output 'A' error OFF	A8332	ACD output 'D' overcurrent
A8005	ACD output 'A' short to battery	A8402	ACD output 'E' error ON
A8006	ACD output 'A' short to earth	A8403	ACD output 'E' error OFF
A8007	ACD output 'A' open circuit	A8405	ACD output 'E' short to battery
A8032	ACD output 'A' overcurrent	A8406	ACD output 'E' short to earth
A8102	ACD output 'B' error ON	A8407	ACD output 'E' open circuit
A8103	ACD output 'B' error OFF	A8432	ACD output 'E' overcurrent
A8105	ACD output 'B' short to battery	A8502	ACD output 'F' error ON
A8106	ACD output 'B' short to earth	A8503	ACD output 'F' error OFF
A8107	ACD output 'B' open circuit	A8505	ACD output 'F' short to battery
A8132	ACD output 'B' overcurrent	A8506	ACD output 'F' short to earth
A8202	ACD output 'C' error ON	A8507	ACD output 'F' open circuit
A8203	ACD output 'C' error OFF	A8532	ACD output 'F' overcurrent



**DIAGNOSTIC SERVICE CODES (CONT'D)**

**Service Codes List (Cont'd)**

CODE	DESCRIPTION	CODE	DESCRIPTION
A8602	ACD output 'G' error ON	D7525	Drive right rear wheel angle sensor out of range high
A8603	ACD output 'G' error OFF	D7526	Drive left rear wheel angle sensor out of range high
A8605	ACD output 'G' short to battery	D7527	Drive left swash plate out of position
A8606	ACD output 'G' short to earth	D7528	Drive right swash plate out of position
A8607	ACD output 'G' open circuit	D7529	Drive left joystick X-axis out of range low
A8702	ACD output 'H' error ON	D7531	Drive left joystick Y-axis out of range low
A8703	ACD output 'H' error OFF	D7532	Drive right joystick Y-axis out of range low
A8705	ACD output 'H' short to battery	D7533	Drive right front wheel angle sensor out of range low
A8706	ACD output 'H' short to earth	D7534	Drive left front wheel angle sensor out of range low
A8707	ACD output 'H' open circuit	D7535	Drive right rear wheel angle sensor out of range low
A8802	Reversing solenoid error ON	D7536	Drive left rear wheel angle sensor out of range low
A8803	Reversing solenoid error OFF	D7537	Drive 5 volt sensor supply 1 out of range low
		D7538	Drive 5 volt sensor supply 2 out of range low
D3905	Left joystick X-axis not in NEUTRAL	D7539	Drive left swash plate sensor out of range high
D3907	Left joystick Y-axis not in NEUTRAL	D7540	Drive left swash plate sensor out of range low
D4007	Right joystick Y-axis not in NEUTRAL	D7541	Drive right swash plate sensor out of range high
D7501	Drive CAN joystick information error	D7542	Drive right swash plate sensor out of range low
D7504	Drive no communication from drive controller	D7543	Drive left forward drive solenoid error ON
D7505	Drive left joystick X-axis not in NEUTRAL	D7544	Drive left reverse drive solenoid error ON
D7507	Drive left joystick Y-axis not in NEUTRAL	D7545	Drive right forward drive solenoid error ON
D7508	Drive right joystick Y-axis not in NEUTRAL	D7546	Drive right reverse drive solenoid error ON
D7509	Drive operating mode switch short to earth or battery	D7547	Drive right front steer extend short to battery
D7510	Drive improper joysticks installed	D7548	Drive left front steer extend short to battery
D7511	Drive left speed sensor not connected	D7549	Drive right rear steer extend short to battery
D7512	Drive right speed sensor not connected	D7550	Drive left rear steer extend short to battery
D7513	Drive right front wheel angle sensor stuck	D7551	Drive steer pressure short to battery
D7514	Drive left front wheel angle sensor stuck	D7552	Drive back-up alarm error ON
D7515	Drive right rear wheel angle sensor stuck	D7553	Drive left forward drive solenoid error OFF
D7516	Drive left rear wheel angle sensor stuck	D7554	Drive left reverse drive solenoid error OFF
D7517	Drive left swash plate not in NEUTRAL	D7555	Drive right forward drive solenoid error OFF
D7518	Drive right swash plate not in NEUTRAL	D7556	Drive right reverse drive solenoid error OFF
D7519	Drive left joystick X-axis out of range high	D7557	Drive right front steer extend short to earth
D7521	Drive left joystick Y-axis out of range high	D7558	Drive right front steer retract short to earth
D7522	Drive right joystick Y-axis out of range high	D7559	Drive left front steer extend short to earth
D7523	Drive right front wheel angle sensor out of range high	D7560	Drive left front steer retract short to earth
D7524	Drive left front wheel angle sensor out of range high	D7561	Drive right rear steer extend short to earth



**DIAGNOSTIC SERVICE CODES (CONT'D)**

**Service Codes List (Cont'd)**

CODE	DESCRIPTION	CODE	DESCRIPTION
D7562	Drive right rear steer retract short to earth	E00002704	EGR actuator position fault
D7563	Drive left rear steer extend short to earth	E00002709	EGR actuator position fault
D7564	Drive left rear steer retract short to earth	E00002710	EGR actuator position fault
D7565	Drive steer pressure short to earth	E00002720	EGR position learning fault
D7566	Drive back-up alarm error OFF	E00002730	EGR position learning fault
D7567	Drive no communication from Bobcat controller	E00002903	Throttle position sensor fault
D7568	Drive angle sensors not calibrated	E00002904	Throttle position sensor fault
D7569	Drive battery voltage out of range high	E00008100	SCR fault
D7570	Drive interrupted power (also occurs after software updates)	E00008107	SCR fault
D7571	Drive battery voltage out of range low	E00008111	SCR fault
D7572	Drive pump not calibrated	E00009102	Throttle position sensor fault
D7573	Drive operating mode switch flipped while operating	E00009103	Throttle position sensor fault
D7574	Drive right wheel speed uncommanded motion	E00009104	Throttle position sensor fault
D7575	Drive left wheel speed uncommanded motion	E00009119	Throttle position sensor fault
D7576	Drive no communication from ACS controller	E00009411	Rail pressure control fault
D7577	Drive left speed sensor out of range high	E00009416	Rail pressure control fault
D7578	Drive right speed sensor out of range high	E00009418	Rail pressure control fault
D7579	Drive left speed sensor out of range low	E00009703	Water in fuel sensor fault
D7580	Drive right speed sensor out of range low	E00009704	Water in fuel sensor fault
D7581	Drive right front steer retract short to battery	E00009709	Water in fuel sensor fault
D7582	Drive left front steer retract short to battery	E00009731	Water in fuel detected
D7583	Drive right rear steer retract short to battery	E00010001	Engine oil pressure too low
D7584	Drive left rear steer retract short to battery	E00010003	Engine oil pressure fault
D7585	Drive 5 volt sensor supply 1 out of range high	E00010004	Engine oil pressure fault
D7586	Drive 5 volt sensor supply 2 out of range high	E00010203	Intake air pressure sensor fault
D7587	Drive software update required	E00010204	Intake air pressure sensor fault
D7588	Drive switched power stuck ON	E00010502	Intake manifold temperature fault
D7589	Drive switched power error OFF	E00010503	Intake manifold temperature sensor fault
D7590	Drive calibration performed	E00010504	Intake manifold temperature sensor fault
D7591	Drive left swash plate sensor reversed	E00010509	Intake manifold temperature sensor fault
D7592	Drive right swash plate sensor reversed	E00010510	Intake manifold temperature sensor fault
D7593	Drive unresponsive right speed sensor	E00010603	Manifold pressure sensor fault
D7594	Drive unresponsive left speed sensor	E00010604	Manifold pressure sensor fault
D7595	Drive left speed sensor reverse direction	E00010609	Manifold pressure sensor fault
D7596	Drive right speed sensor reverse direction	E00010803	Barometric pressure fault
D7597	Drive controller programmed	E00010804	Barometric pressure fault
D7598	Drive controller in calibration mode	E00010809	Barometric pressure fault
D7599	Drive AWS controller in wheel position calibration mode	E00011000	Engine temperature extremely high
		E00011002	Engine coolant temperature fault
E00002700	EGR control fault	E00011003	Water temperature sensor fault
E00002701	EGR control fault	E00011004	Water temperature sensor fault
E00002703	EGR actuator position fault	E00011031	Engine coolant temperature sensor fault



**DIAGNOSTIC SERVICE CODES (CONT'D)**

**Service Codes List (Cont'd)**

CODE	DESCRIPTION	CODE	DESCRIPTION
E00013200	Intake air volume fault	E00063602	Crank position sensor fault
E00013201	Intake air volume fault	E00063607	Cam or crank sensor fault
E00013203	MAF sensor fault	E00063608	Crank position sensor fault
E00013204	MAF sensor fault	E00063611	Crank position sensor fault
E00013209	MAF sensor fault	E00063702	Cam signal fault
E00013215	Boost pressure fault	E00063708	Cam signal fault
E00013231	MAF sensor fault	E00063720	Cam signal fault
E00015700	Rail pressure fault	E00063730	Cam signal fault
E00015702	Rail pressure sensor fault	E00063919	ECU communication error
E00015703	Rail pressure sensor fault	E00064103	Boost control fault
E00015704	Rail pressure sensor fault	E00064104	Boost control fault
E00015710	Rail pressure fault	E00065103	Injector #1 fault
E00015711	Rail pressure fault	E00065105	Injector #1 fault
E00015721	Rail pressure control fault	E00065106	Injector #1 fault
E00015722	Rail pressure control fault	E00065120	Injector #1 fault
E00016803	System voltage too high	E00065121	Injector #1 fault
E00016804	System voltage too low	E00065131	Injector #1 fault
E00017103	MAF sensor fault	E00065203	Injector #2 fault
E00017104	MAF sensor fault	E00065205	Injector #2 fault
E00017200	Intake air temperature too high	E00065206	Injector #2 fault
E00017202	Intake air temperature sensor fault	E00065220	Injector #2 fault
E00017203	Intake air temperature sensor fault	E00065221	Injector #2 fault
E00017204	Intake air temperature sensor fault	E00065231	Injector #2 fault
E00017209	Intake air temperature sensor fault	E00065303	Injector #3 fault
E00017300	Exhaust over temperature fault	E00065305	Injector #3 fault
E00017301	DOC exothermal efficiency fault	E00065306	Injector #3 fault
E00017302	SCR inlet temperature sensor fault	E00065320	Injector #3 fault
E00017400	Fuel temperature too high	E00065321	Injector #3 fault
E00017402	Fuel temperature fault	E00065331	Injector #3 fault
E00017403	Fuel temperature sensor fault	E00065403	Injector #4 fault
E00017404	Fuel temperature sensor fault	E00065405	Injector #4 fault
E00017409	Fuel temperature sensor fault	E00065406	Injector #4 fault
E00017502	Engine oil temperature fault	E00065420	Injector #4 fault
E00017531	Engine oil temperature sensor fault	E00065421	Injector #4 fault
E00019000	Engine speed extremely high	E00065431	Injector #4 fault
E00062802	ECU fault	E00067603	Glow plug relay fault
E00062912	ECU fault	E00067604	Glow plug relay fault
E00063011	Injector data fault	E00067605	Glow plug relay fault
E00063023	ECU fault	E00072302	Camshaft position sensor fault
E00063024	ECU fault	E00072308	Camshaft position sensor fault
E00063025	ECU fault	E00073120	Accelerometer fault
E00063031	ECU fault	E00073121	Accelerometer fault
E00063307	Rail pressure fault	E00107600	Rail pressure control fault
E00063600	Crank position sensor fault	E00107601	Rail pressure control fault
E00063601	Crank position sensor fault	E00107603	Rail pressure control fault



**DIAGNOSTIC SERVICE CODES (CONT'D)**

**Service Codes List (Cont'd)**

CODE	DESCRIPTION	CODE	DESCRIPTION
E00107604	Rail pressure control fault	E00122130	ECU fault
E00107609	Rail pressure control fault	E00122131	ECU safety monitoring fault
E00107615	Rail pressure control fault	E00122132	ECU fault
E00107616	Rail pressure control fault	E00122133	ECU fault
E00107617	Rail pressure control fault	E00122134	ECU fault
E00107618	Rail pressure control fault	E00122135	ECU fault
E00107620	Rail pressure control fault	E00122136	ECU fault
E00107631	Rail pressure control fault	E00122137	ECU fault
E00107702	ECU fault	E00122138	ECU fault
E00118002	Turbo temperature fault	E00122139	ECU fault
E00118003	Turbo temperature sensor fault	E00122140	ECU fault
E00118004	Turbo temperature sensor fault	E00122141	ECU fault
E00118009	Turbo temperature sensor fault	E00122142	ECU fault
E00118010	Turbo temperature sensor fault	E00122143	ECU fault
E00118031	Turbo temperature sensor fault	E00122144	ECU fault
E00122100	ECU fault	E00122145	ECU fault
E00122101	ECU fault	E00122146	ECU fault
E00122102	ECU fault	E00122147	ECU fault
E00122103	ECU safety monitoring fault	E00122148	ECU fault
E00122104	ECU safety monitoring fault	E00122149	ECU fault
E00122105	ECU fault	E00122150	ECU fault
E00122106	ECU fault	E00122151	ECU fault
E00122107	ECU fault	E00122152	ECU fault
E00122108	ECU fault	E00122153	ECU fault
E00122109	ECU fault	E00122154	ECU fault
E00122110	ECU fault	E00122155	ECU fault
E00122111	ECU safety monitoring fault	E00122156	ECU fault
E00122112	ECU fault	E00122157	ECU fault
E00122113	ECU fault	E00122158	ECU fault
E00122114	ECU fault	E00122159	ECU fault
E00122115	ECU fault	E00122160	ECU fault
E00122116	ECU fault	E00122161	ECU fault
E00122117	ECU fault	E00122162	ECU fault
E00122118	ECU fault	E00122163	ECU fault
E00122119	ECU safety monitoring fault	E00122164	ECU fault
E00122120	ECU fault	E00122165	ECU fault
E00122121	ECU fault	E00122166	ECU fault
E00122122	ECU fault	E00122167	ECU fault
E00122123	ECU fault	E00122168	ECU fault
E00122124	ECU fault	E00122169	ECU fault
E00122125	ECU fault	E00122170	ECU fault
E00122126	ECU safety monitoring fault	E00122171	ECU fault
E00122127	ECU safety monitoring fault	E00122172	ECU fault
E00122128	ECU safety monitoring fault	E00122173	ECU fault
E00122129	ECU safety monitoring fault	E00122174	ECU fault



**DIAGNOSTIC SERVICE CODES (CONT'D)**

**Service Codes List (Cont'd)**

CODE	DESCRIPTION	CODE	DESCRIPTION
E00122175	ECU fault	E00324204	Exhaust gas temperature sensor fault
E00122176	ECU fault	E00324216	Exhaust gas temperature sensor fault
E00122177	ECU fault	E00324600	Exhaust temperature extremely high
E00122178	ECU fault	E00324603	EGR temperature sensor fault
E00122179	ECU fault	E00324604	EGR temperature sensor fault
E00122180	ECU fault	E00324616	Exhaust gas temperature sensor fault
E00122181	ECU fault	E00325100	Differential pressure sensor fault
E00122182	ECU fault	E00325101	Differential pressure sensor fault
E00122183	ECU fault	E00325103	EGR temperature sensor fault
E00122184	ECU fault	E00325104	EGR temperature sensor fault
E00122185	ECU fault	E00325200	Exhaust temperature too high
E00122186	ECU fault	E00350903	Sensor supply voltage fault
E00122187	ECU fault	E00350904	Sensor supply voltage fault
E00122188	ECU fault	E00350911	5 volt sensor supply #1 fault
E00122189	ECU fault	E00351003	Sensor supply voltage fault
E00122190	ECU fault	E00351004	Sensor supply voltage fault
E00122191	ECU fault	E00351011	5 volt sensor supply #2 fault
E00122192	ECU fault	E00351111	5 volt aux sensor supply #2 fault
E00122193	ECU fault	E00370100	Particulate matter extremely high
E00122194	ECU fault	E00370115	Particulate matter warning
E00122195	ECU fault	E00370116	Particulate matter too high
E00122196	ECU fault	E00408203	Inlet metering valve fault
E00122197	ECU fault	E00408204	Inlet metering valve fault
E00122198	ECU fault	E00408205	Inlet metering valve fault
E00122199	ECU fault	E00408206	Inlet metering valve fault
E00123901	High pressure fuel leak	E00425600	Unknown SCR fault
E00134703	High pressure pump fault	E00476500	Exhaust temperature extremely high
E00134704	High pressure pump fault	E00476503	Exhaust gas temperature sensor fault
E00134707	High pressure pump fault	E00476504	Exhaust gas temperature sensor fault
E00148502	ECU main relay fault	E00476518	Exhaust gas temperature sensor fault
E00148507	ECU main relay fault	E00524600	DEF level empty
E00148511	ECU main relay fault	E00524615	DEF level too low
E00161203	Injector #1 and #4 fault	E00524616	DEF level extremely low
E00161204	Injector #1 and #4 fault	E00524617	DEF level too low
E00161211	Injector #1 and #4 fault	E00524619	DCU CAN communication fault
E00161303	Injector #2 and #3 fault	E00524621	Blocked EGR fault
E00161304	Injector #2 and #3 fault	E00524622	Dosing interrupted fault
E00161311	Injector #2 and #3 fault	E00524623	DEF consumption fault
E00279103	EGR motor fault	E00524624	DEF quality fault
E00279104	EGR motor fault	E00524625	Tampering fault
E00279105	EGR motor fault	E00524626	DEF consumption fault
E00279107	EGR blocked fault	E00532403	Glow plug signal fault
E00279108	EGR position fault	E00532404	Glow plug signal fault
E00324200	Exhaust temperature extremely high	E52352302	Injector #1 and #4 fault
E00324203	Exhaust gas temperature sensor fault	E52352303	Injector #1 and #4 fault



**DIAGNOSTIC SERVICE CODES (CONT'D)**

**Service Codes List (Cont'd)**

CODE	DESCRIPTION	CODE	DESCRIPTION
E52352304	Injector #1 and #4 fault	E52360402	ECU communication fault
E52352402	Injector #2 and #3 fault	E52370013	ECU fault
E52352403	Injector #2 and #3 fault		
E52352404	Injector #2 and #3 fault	H0921	Boost sensor out of range high
E52352501	Injector fault	H0922	Boost sensor out of range low
E52352702	ECU fault	H1221	Right thumb switch out of range high
E52353500	Injector fault	H1222	Right thumb switch out of range low
E52353602	EGR fault	H1224	Right thumb switch not in NEUTRAL
E52353702	EGR fault	H1321	Left thumb switch out of range high
E52353802	ECU fault	H1322	Left thumb switch out of range low
E52353807	ECU fault	H1324	Left thumb switch not in NEUTRAL
E52353902	Fuel pump fault	H1421	Lift base pressure out of range high
E52354002	Fuel pump fault	H1422	Lift base pressure out of range low
E52354103	EGR fault	H1502	Ride control output error ON
E52354104	EGR fault	H1503	Ride control output error OFF
E52354302	Throttle position sensor fault	H1507	Ride control output open circuit
E52354403	Intake heater fault	H1528	Ride control output failure
E52354404	Intake heater fault	H1602	Ride control relay error ON
E52354702	ECU communication error	H1603	Ride control relay error OFF
E52354802	ECU communication error	H2105	Reverse fan solenoid short to battery
E52357204	EGR position sensor fault	H2106	Reverse fan solenoid short to earth
E52357403	EGR actuator fault	H2107	Reverse fan solenoid open circuit
E52357404	EGR actuator fault	H2132	Reverse fan solenoid overcurrent
E52357507	EGR actuator fault	H2305	Rear base output short to battery
E52357602	EGR motor fault	H2306	Rear base output short to earth
E52357702	EGR temperature sensor fault	H2307	Rear base output open circuit
E52357802	EGR fault	H2332	Rear base output overcurrent
E52358002	Intake throttle fault	H2405	Rear rod output short to battery
E52358203	Intake throttle lift sensor fault	H2406	Rear rod output short to earth
E52358204	Intake throttle lift sensor fault	H2407	Rear rod output open circuit
E52358917	Low water temperature in parked regeneration	H2432	Rear rod output overcurrent
E52359016	Parked regeneration time out	H2502	Diverter #2 short to battery
E52359102	ECU communication fault	H2503	Diverter #2 short to earth
E52359202	ECU communication fault	H2505	Diverter #2 short to battery
E52359302	ECU communication fault	H2506	Diverter #2 short to earth
E52359402	ECU communication fault	H2507	Diverter #2 open circuit
E52359502	ECU communication fault	H2605	Front base output short to battery
E52359602	ECU communication fault	H2606	Front base output short to earth
E52359800	DOC failure	H2607	Front base output open circuit
E52359802	ECU communication fault	H2632	Front base output overcurrent
E52359900	Exhaust temperature sensor fault	H2705	Front rod output short to battery
E52360000	Pump calibration error	H2706	Front rod output short to earth
E52360100	Exhaust gas temperature sensor fault	H2707	Front rod output open circuit
E52360200	DPF fault	H2732	Front rod output overcurrent
E52360315	Water temperature sensor fault	H2805	Diverter short to battery



**DIAGNOSTIC SERVICE CODES (CONT'D)**

**Service Codes List (Cont'd)**

CODE	DESCRIPTION	CODE	DESCRIPTION
H2806	Diverter short to earth	M0311	System voltage extremely high
H2807	Diverter open circuit	M0314	System voltage extremely low
H2905	High-flow short to battery	M0322	System voltage out of range low
H2906	High-flow short to earth	M0409	Engine oil pressure too low
H2907	High-flow open circuit	M0414	Engine oil pressure extremely low
H2932	High-flow overcurrent	M0415	Engine oil pressure in shutdown
H3128	Interrupted power failure	M0421	Engine oil pressure out of range high
H3648	Multiple ACD conflict error	M0422	Engine oil pressure out of range low
H3904	Left joystick in error	M0509	Hydraulic charge pressure too low
H3912	Left joystick thumb switch not in NEUTRAL	M0510	Hydraulic charge pressure too high
H3913	Left joystick grip no communication	M0511	Hydraulic charge pressure extremely high
H3916	Left joystick no communication	M0514	Hydraulic charge pressure extremely low
H3928	Left joystick internal failure	M0515	Hydraulic charge pressure in shutdown
H3948	Left joystick multiple	M0521	Hydraulic charge pressure out of range high
H4004	Right joystick in error	M0522	Hydraulic charge pressure out of range low
H4012	Right joystick thumb switch not in NEUTRAL	M0610	Engine speed too high
H4013	Right joystick grip no communication	M0611	Engine speed extremely high
H4016	Right joystick no communication	M0613	Engine speed no signal
H4028	Right joystick internal failure	M0615	Engine speed in shutdown
H4048	Right joystick multiple	M0618	Engine speed out of range
H4302	Horn error ON	M0634	Engine speed invalid information from ECU
H4303	Horn error OFF	M0710	Hydraulic fluid temperature too high
H4423	Auxiliary not programmed	M0711	Hydraulic fluid temperature extremely high
H4497	Auxiliary controller programmed	M0715	Hydraulic fluid temperature in shutdown
H4502	Right blinker error ON	M0721	Hydraulic fluid temperature out of range high
H4503	Right blinker error OFF	M0722	Hydraulic fluid temperature out of range low
H4602	Left blinker error ON	M0810	Engine coolant temperature too high
H4603	Left blinker error OFF	M0811	Engine coolant temperature extremely high
H4721	8 volt sensor supply out of range high	M0815	Engine coolant temperature in shutdown
H4722	8 volt sensor supply out of range low	M0821	Engine coolant temperature out of range high
H7404	Main controller no communication	M0822	Engine coolant temperature out of range low
		M0826	Engine coolant temperature pre-shutdown
L0102	Lights button error ON	M0909	Fuel level too low
L0202	High-flow enable button error ON	M0921	Fuel level out of range high
L0302	Auxiliary enable button error ON	M0922	Fuel level out of range low
L0402	Information button error ON	M1016	Hydraulic charge filter not connected
L7404	Main controller no communication	M1017	Hydraulic charge filter plugged
L7672	Left display panel needs programming	M1121	Seat bar sensor out of range high
		M1122	Seat bar sensor out of range low
M0116	Air filter not connected	M1128	Seat bar sensor
M0117	Air filter plugged	M1210	Intake air temperature too high
M0216	Hydraulic / Hydrostatic filter not connected	M1211	Intake air temperature extremely high
M0217	Hydraulic / Hydrostatic filter plugged	M1305	Fuel hold solenoid short to battery
M0309	System voltage too low	M1306	Fuel hold solenoid short to earth
M0310	System voltage too high	M1307	Fuel hold solenoid open circuit





**DIAGNOSTIC SERVICE CODES (CONT'D)**

**Service Codes List (Cont'd)**

CODE	DESCRIPTION	CODE	DESCRIPTION
M1402	Fuel pull solenoid error ON	M2722	Throttle primary sensor out of range low
M1403	Fuel pull solenoid error OFF	M2821	Throttle secondary sensor out of range high
M1407	Fuel pull solenoid open circuit	M2822	Throttle secondary sensor out of range low
M1428	Fuel pull solenoid failure	M2899	Throttle secondary sensor not calibrated
M1502	Traction lock pull output error ON	M2910	Exhaust gas temperature too high
M1503	Traction lock pull output error OFF	M3028	Controller memory failure
M1507	Traction lock pull output open circuit	M3128	Interrupted power failure
M1528	Traction lock pull output failure	M3204	ACS (AHC) no communication to Bobcat controller
M1605	Traction lock hold solenoid short to battery	M3304	Deluxe panel no communication
M1606	Traction lock hold solenoid short to earth	M3404	Deluxe panel in error
M1607	Traction lock hold solenoid open circuit	M3505	Hydraulic fan short to battery
M1705	Hydraulic lock valve short to battery	M3506	Hydraulic fan short to earth
M1706	Hydraulic lock valve short to earth	M3507	Hydraulic fan open circuit
M1707	Hydraulic lock valve open circuit	M3532	Hydraulic fan overcurrent
M1732	Hydraulic lock valve overcurrent	M3705	Two-speed second output short to battery
M1805	Lift spool lock output short to battery	M3706	Two-speed second output short to earth
M1806	Lift spool lock output short to earth	M3707	Two-speed second output open circuit
M1807	Lift spool lock output open circuit	M3732	Two-speed second output overcurrent
M1832	Lift spool lock output overcurrent	M3805	Auxiliary hydraulic lock short to battery
M1910	Engine compartment temperature too high	M3806	Auxiliary hydraulic lock short to earth
M1911	Engine compartment temperature extremely high	M3807	Auxiliary hydraulic lock open circuit
M1921	Engine compartment temperature out of range high	M3832	Auxiliary hydraulic lock overcurrent
M1922	Engine compartment temperature out of range low	M4028	Wrong ECU detected
M2005	Two-speed primary solenoid short to battery	M4109	Alternator voltage too low
M2006	Two-speed primary solenoid short to earth	M4110	Alternator voltage high
M2007	Two-speed primary solenoid open circuit	M4111	Alternator voltage extremely high
M2032	Two-speed primary solenoid overcurrent	M4228	Wrong DCU detected
M2102	Glow plug output error ON	M4304	Keyless panel no communication
M2103	Glow plug output error OFF	M4404	Auxiliary no communication
M2107	Glow plug output open circuit	M4510	Water in fuel sensor too high
M2128	Glow plug output failure	M4511	Water in fuel sensor extremely high
M2202	Starter output error ON	M4521	Water in fuel sensor out of range high
M2203	Starter output error OFF	M4522	Water in fuel sensor out of range low
M2207	Starter output open circuit	M4530	Water in fuel sensor fault
M2228	Starter output failure	M4621	5 volt sensor supply out of range high
M2302	Starter relay error ON	M4622	5 volt sensor supply out of range low
M2303	Starter relay error OFF	M4721	8 volt sensor supply out of range high
M2402	Fuel pull relay error ON	M4722	8 volt sensor supply out of range low
M2403	Fuel pull relay error OFF	M4802	Front light relay error ON
M2502	Traction pull relay error ON	M4803	Front light relay error OFF
M2503	Traction pull relay error OFF	M4902	Rear light relay error ON
M2602	Glow plug relay error ON	M4903	Rear light relay error OFF
M2603	Glow plug relay error OFF	M5002	Front light output error ON
M2721	Throttle primary sensor out of range high	M5003	Front light output error OFF



**DIAGNOSTIC SERVICE CODES (CONT'D)**

**Service Codes List (Cont'd)**

CODE	DESCRIPTION	CODE	DESCRIPTION
M5007	Front light output open circuit	M7007	Switched power output open circuit
M5028	Front light output failure	M7028	Switched power output failure
M5102	Rear light output error ON	M7102	Electric fan output error ON
M5103	Rear light output error OFF	M7103	Electric fan output error OFF
M5107	Rear light output open circuit	M7107	Electric fan output open circuit
M5128	Rear light output failure	M7202	Electric fan relay error ON
M5202	Press to operate button error ON	M7203	Electric fan relay error OFF
M5221	Press to operate button out of range high	M7304	Remote control no communication
M5222	Press to operate button out of range low	M7316	Remote control no communication to transmitter
M5305	Press to operate light short to battery	M7423	Main controller not programmed
M5306	Press to operate light short to earth	M7472	Main controller needs programming
M5405	Tilt spool lock short to battery	M7497	Main controller programmed
M5406	Tilt spool lock short to earth	M7504	Drive no communication
M5407	Tilt spool lock open circuit	M7604	Left display panel no communication
M5432	Tilt spool lock overcurrent	M7748	Key switch multiple
M5810	Fuel temperature too high	M7839	Hourmeter changed
M5811	Fuel temperature extremely high	M7974	Door open
M5815	Fuel temperature in shutdown	M8402	DESOX service requested
M5826	Fuel temperature pre-shutdown	M8450	DESOX regeneration needed - inhibit active
M5902	DPF regeneration switch error ON	M8541	DPF automatic regeneration active
M6002	DPF inhibit regeneration switch error ON	M8542	DPF automatic regeneration active (Operate machine under load)
M6102	Remote parked regeneration switch error ON	M8543	DPF regeneration required
M6202	Tailgate fan 1 error ON	M8551	DPF regeneration needed – inhibit active
M6203	Tailgate fan 1 error OFF	M8552	DPF regeneration needed – inhibit active (Operate machine under load)
M6228	Tailgate fan 1 Failure	M8553	DPF remote parked regeneration required (Remote regeneration kit required)
M6302	Tailgate fan 2 error ON	M8554	DPF service regeneration required (Contact Bobcat dealer)
M6303	Tailgate fan 2 error OFF	M8555	DPF service required
M6328	Tailgate fan 2 Failure	M8560	DPF service regeneration active
M6402	Switched power relay error ON	M8561	DPF service regeneration active
M6403	Switched power relay error OFF	M8562	DPF service regeneration active
M6505	ECU power short to battery	M8563	DPF service regeneration active
M6506	ECU power short to earth	M8564	DPF service regeneration active
M6507	ECU power open circuit	M8615	Engine speed derate in shutdown
M6604	ECU no communication	M8625	Engine speed derate unresponsive
M6702	HVAC output error ON	M8715	Torque derate in shutdown
M6703	HVAC output error OFF	M8725	Torque derate unresponsive
M6707	HVAC output open circuit		
M6728	HVAC output failure	R7404	Main controller no communication
M6802	HVAC relay error ON		
M6803	HVAC relay error OFF	T9002	Service tool output 'C' error ON
M6904	DCU no communication	T9003	Service tool output 'C' error OFF
M7002	Switched power output error ON	T9102	Service tool output 'D' error ON
M7003	Switched power output error OFF	T9103	Service tool output 'D' error OFF



**DIAGNOSTIC SERVICE CODES (CONT'D)**

**Service Codes List (Cont'd)**

CODE	DESCRIPTION	CODE	DESCRIPTION
T9202	Service tool output 'E' error ON	U00321919	NOX pre-treatment sensor fault
T9203	Service tool output 'E' error OFF	U00322021	NOX pre-treatment sensor fault
T9302	Service tool output 'F' error ON	U00322022	NOX post-treatment sensor fault
T9303	Service tool output 'F' error OFF	U00322023	NOX pre-treatment sensor fault
U00015822	DCU activation signal fault	U00322024	NOX post-treatment sensor fault
U00017100	Environment temperature too high	U00322025	NOX pre-treatment sensor fault
U00017101	Environment temperature too low	U00322026	NOX post-treatment sensor fault
U00017103	Environment temperature sensor fault	U00322103	NOX pre-treatment sensor fault
U00017104	Environment temperature sensor fault	U00322104	NOX pre-treatment sensor fault
U00044400	Battery voltage high	U00322302	NOX pre-treatment sensor fault
U00044401	Battery voltage too low	U00322400	NOX pre-treatment sensor fault
U00044402	Battery voltage fault	U00322401	NOX pre-treatment sensor fault
U00054419	DCU communication fault	U00322403	NOX pre-treatment sensor fault
U00063928	DCU communication fault	U00322404	NOX pre-treatment sensor fault
U00063929	DCU communication fault	U00322419	NOX pre-treatment sensor fault
U00155719	DCU communication fault	U00322423	NOX pre-treatment sensor fault
U00176100	DEF level too high	U00322519	NOX pre-treatment sensor fault
U00176101	DEF level too low	U00322604	NOX post-treatment sensor short circuit
U00176115	DEF level extremely low	U00322605	NOX post-treatment sensor open circuit
U00176116	DEF level empty	U00322619	NOX post-treatment sensor fault
U00176119	DEF level signal fault	U00322701	NOX post-treatment sensor fault
U00176120	DEF fill level fault	U00322703	NOX post-treatment sensor fault
U00176121	DEF fill level fault	U00322704	NOX post-treatment sensor fault
U00303100	DEF temperature too high	U00322719	NOX post-treatment sensor fault
U00303101	DEF temperature too low	U00322722	NOX post-treatment sensor fault
U00303103	DEF temperature fault	U00322724	NOX post-treatment sensor fault
U00303104	DEF temperature fault	U00322807	NOX post-treatment sensor fault
U00303120	DEF temperature fault	U00322819	NOX post-treatment sensor fault
U00303121	DEF temperature fault	U00322824	NOX post-treatment sensor fault
U00303123	DEF overheating	U00322919	NOX post-treatment sensor fault
U00303127	DEF temperature sensor fault	U00323103	NOX post-treatment sensor fault
U00303131	DEF temperature signal fault	U00323104	NOX post-treatment sensor fault
U00321604	NOX pre-treatment sensor short circuit	U00323302	NOX post-treatment sensor fault
U00321605	NOX pre-treatment sensor open circuit	U00323400	NOX post-treatment sensor fault
U00321619	NOX pre-treatment sensor fault	U00323401	NOX post-treatment sensor fault
U00321700	NOX pre-treatment sensor fault	U00323403	NOX post-treatment sensor fault
U00321703	NOX pre-treatment sensor fault	U00323404	NOX post-treatment sensor fault
U00321704	NOX pre-treatment sensor fault	U00323419	NOX post-treatment sensor fault
U00321719	NOX pre-treatment sensor fault	U00323424	NOX post-treatment sensor fault
U00321721	NOX pre-treatment sensor fault	U00323519	NOX post-treatment sensor fault
U00321723	NOX pre-treatment sensor fault	U00336103	Dosing valve short to battery
U00321807	NOX pre-treatment sensor fault	U00336104	Dosing valve short to ground
U00321819	NOX pre-treatment sensor fault	U00336105	Dosing valve short to battery
U00321823	NOX pre-treatment sensor fault	U00336112	Dosing valve temperature too high



**DIAGNOSTIC SERVICE CODES (CONT'D)**

**Service Codes List (Cont'd)**

CODE	DESCRIPTION	CODE	DESCRIPTION
U00336122	Dosing valve short to ground	U00433712	Dosing valve tip temperature fault
U00336127	Dosing valve blocked	U00433912	NOX controller fault
U00336303	DEF tank coolant valve short to battery	U00434003	DEF line heater short to battery
U00336304	DEF tank coolant valve short to ground	U00434205	DEF outlet line heater short to ground or open circuit
U00336305	DEF tank coolant valve open circuit	U00434402	Backflow fault
U00336312	DEF tank coolant valve temperature too high	U00434405	DEF backflow line heater short to ground or open circuit
U00349212	DCU fault	U00434605	DEF inlet line heater short to ground or open circuit
U00349231	DCU fault	U00435303	DEF heater relay short to battery
U00350923	DCU fault	U00435304	DEF heater relay short to ground
U00350924	DCU fault	U00435305	DEF heater relay open circuit
U00351023	DCU fault	U00435312	DEF heater relay overtemperature
U00351024	DCU fault	U00435502	Outlet line heater fault
U00351123	DCU fault	U00435503	Outlet line heater short to battery
U00351124	DCU fault	U00435504	Outlet line heater short to ground
U00351223	DCU fault	U00435505	Outlet line heater open circuit
U00351224	DCU fault	U00435512	Outlet line heater overtemperature
U00351600	DEF quality too high	U00435514	Outlet line heater fault
U00351601	DEF quality too low	U00435602	Backflow line heater short to battery
U00351603	DEF quality sensor fault	U00435603	Backflow line heater short to ground
U00351604	DEF quality sensor fault	U00435604	Backflow line heater open circuit
U00351611	DEF quality sensor fault	U00435605	Backflow line heater overtemperature
U00351631	DEF quality sensor fault	U00435612	Backflow line heater fault
U00353203	DEF level sensor fault	U00435702	Inlet line heater short to battery
U00353204	DEF level sensor fault	U00435703	Inlet line heater short to ground
U00353211	DEF level sensor fault	U00435704	Inlet line heater open circuit
U00431915	SCR post-treatment temperature fault	U00435705	Inlet line heater overtemperature
U00431917	SCR post-treatment temperature fault	U00435712	Inlet line heater fault
U00433401	DEF pump pressure too low	U00436000	SCR pre-treatment temperature too high
U00433403	DEF pump pressure max	U00436001	SCR pre-treatment temperature too low
U00433404	DEF pump pressure min	U00436003	SCR pre-treatment temperature sensor out of range high
U00433419	DEF pump pressure fault	U00436004	SCR pre-treatment temperature sensor out of range low
U00433420	DEF pump pressure too high	U00436020	SCR pre-treatment temperature fault
U00433421	DEF pump pressure too low	U00436021	SCR pre-treatment temperature fault
U00433422	Backflow pump fault	U00436022	SCR pre-treatment temperature fault
U00433500	Metering control overpressure	U00436025	SCR pre-treatment temperature sensor tampering
U00433501	Metering control underpressure	U00436300	SCR post-treatment temperature too high
U00433502	Monitoring of pressure buildup	U00436301	SCR downstream temperature too low
U00433512	Monitoring of overpressure	U00436303	SCR downstream temperature sensor out of range high
U00433707	Dosing valve tip temperature fault	U00436304	SCR downstream temperature sensor out of range low



**DIAGNOSTIC SERVICE CODES (CONT'D)**

**Service Codes List (Cont'd)**

CODE	DESCRIPTION	CODE	DESCRIPTION
U00436322	SCR post-treatment temperature fault	U00503519	NOX post-treatment CAN communication fault
U00436325	SCR downstream temperature sensor tampering	U00503619	NOX post-treatment CAN communication fault
U00436400	NOX pre-treatment fault	U00503719	NOX post-treatment CAN communication fault
U00436401	NOX pre-treatment fault	U00543510	Pressure stabilization fault
U00436416	SCR fault	U00543512	General pressure check fault
U00436418	SCR fault	U00543529	DEF pump motor fault
U00436420	SCR fault	U00570622	Supply module heater fault
U00436421	SCR fault	U00570623	Supply module heater fault
U00436422	SCR fault	U00570624	Supply module heater fault
U00436423	SCR fault	U00570626	Supply module heater temperature fault
U00436503	DEF temperature sensor open circuit	U00570627	Supply module heater temperature fault
U00436504	DEF temperature sensor short to ground	U00570703	Supply module heater short to battery
U00436511	DEF temperature sensor failure	U00570704	Supply module heater short to ground
U00437423	DEF pump motor speed fault	U00570705	Supply module heater open circuit
U00437424	DEF pump motor speed fault	U00570712	Supply module heater overtemperature
U00437428	DEF pump motor speed fault	U00570723	Supply module heater temperature duty high
U00437430	DEF pump motor speed fault	U00570724	Supply module heater temperature duty low
U00437503	DEF pump motor short to battery	U00570726	Supply module heater temperature fault
U00437504	DEF pump motor short to ground	U00570727	Supply module heater temperature fault
U00437505	DEF pump motor open circuit	U00571302	NOX sensor self diagnostics
U00437512	DEF pump motor overtemperature	U00571307	NOX sensor self diagnostics
U00437523	DEF pump motor fault	U00571319	NOX sensor self diagnostics
U00437524	DEF pump motor fault	U00571402	NOX sensor self diagnostics
U00437603	DEF backflow pump short to battery	U00571407	NOX sensor self diagnostics
U00437604	DEF backflow pump short to ground	U00571419	NOX sensor self diagnostics
U00437605	DEF backflow pump open circuit	U05990419	CAN communications fault
U00437612	DEF backflow pump overtemperature	U06016019	CAN communications fault
U00476500	DOC pre-treatment temperature too high	U06041619	CAN communications fault
U00476501	DOC pre-treatment temperature too low	U06144419	CAN communications fault
U00476503	DOC pre-treatment temperature sensor out of range high	U06145419	CAN communications fault
U00476504	DOC pre-treatment temperature sensor out of range low	U06145519	CAN communications fault
U00502419	NOX pre-treatment CAN communication fault	U06463919	Memory fault
U00502519	NOX pre-treatment CAN communication fault	U06463931	Memory fault
U00502619	NOX pre-treatment CAN communication fault	U06478219	CAN communications fault
U00502719	NOX pre-treatment CAN communication fault	U06478319	CAN communications fault
U00502819	NOX pre-treatment CAN communication fault	U06478419	CAN communications fault
U00502919	NOX pre-treatment CAN communication fault	U06478519	CAN communications fault
U00503019	NOX pre-treatment CAN communication fault	U06480019	CAN communications fault
U00503119	NOX post-treatment CAN communication fault	U06481719	CAN communications fault
U00503219	NOX post-treatment CAN communication fault	U06488919	CAN communications fault
U00503319	NOX post-treatment CAN communication fault	U06491619	CAN communications fault
U00503419	NOX post-treatment CAN communication fault	U06492319	CAN communications fault



**DIAGNOSTIC SERVICE CODES (CONT'D)**

**Service Codes List (Cont'd)**

CODE	DESCRIPTION	CODE	DESCRIPTION
U06516419	CAN communications fault	W3232	ACS (AHC) tilt actuator wiring
U06522619	CAN communications fault	W3233	ACS (AHC) tilt handle wiring
U06522621	CAN communications fault	W3234	ACS (AHC) tilt actuator not in NEUTRAL
U06522622	CAN communications fault	W3235	ACS (AHC) tilt handle / pedal not in NEUTRAL
U06522623	CAN communications fault	W3236	ACS (AHC) lift actuator
U06522624	CAN communications fault	W3237	ACS (AHC) lift actuator wiring
U06522625	CAN communications fault	W3238	ACS (AHC) lift handle wiring
U06524719	CAN communications fault	W3239	ACS (AHC) lift actuator not in NEUTRAL
U06526219	CAN communications fault	W3240	ACS (AHC) lift handle / pedal not in NEUTRAL
U06526919	CAN communications fault	W3241	ACS (AHC) no communication
U06527019	CAN communications fault	W3249	ACS (AHC) lift actuator short to ground
U06529619	CAN communications fault	W3250	ACS (AHC) tilt actuator short to ground
U06530019	CAN communications fault	W3251	ACS (AHC) lift actuator short to battery
U10123907	DEF hose leak	W3252	ACS (AHC) tilt actuator short to battery
U10124007	Evaluate filter clog	W3253	ACS (AHC) lift handle / pedal short to ground
U10433207	NOX pre-treatment fault	W3254	ACS (AHC) tilt handle / pedal short to ground
U10433209	NOX pre-treatment fault	W3255	ACS (AHC) lift handle / pedal short to battery
U10433219	NOX pre-treatment fault	W3256	ACS (AHC) tilt handle / pedal short to battery
U10433221	NOX pre-treatment fault	W3257	ACS (AHC) lift actuator reduced performance
U10433223	NOX pre-treatment fault	W3258	ACS (AHC) tilt actuator reduced performance
U10433224	NOX pre-treatment fault	W3259	ACS (AHC) lift actuator wrong direction
U10438507	NOX post-treatment fault	W3260	ACS (AHC) tilt actuator wrong direction
U10438509	NOX post-treatment fault	W3261	ACS (AHC) handle lock short to ground
U10438519	NOX post-treatment fault	W3262	ACS (AHC) handle lock short to battery
U10438522	NOX post-treatment fault	W3263	ACS (AHC) pedal lock short to ground
U10564413	DCU fault	W3264	ACS (AHC) pedal lock short to battery
U10564513	DCU fault	W3265	ACS (AHC) sensor supply voltage out of range
U10564613	DCU fault	W3266	ACS (AHC) battery voltage out of range
U52020212	DCU fault	W3267	ACS (AHC) switch flipped while operating
U52020412	DCU fault	W3268	ACS (AHC) lift handle information error
U52069812	DCU fault	W3269	ACS (AHC) control mode toggle switched while operating
U52069912	DCU fault	W3270	ACS (AHC) right drive handle short to ground
U52070012	DCU fault	W3271	ACS (AHC) right drive handle short to battery
U52070112	DCU fault	W3274	ACS (AHC) left joystick X-axis out of range
U52160212	DCU sensor supply error	W3275	ACS (AHC) interrupted unswitched power
		W3276	ACS (AHC) CAN joystick information error
W3204	ACS (AHC) no communication to Bobcat controller	W3277	ACS (AHC) remote control information error
W3223	ACS (AHC) calibration required	W3297	ACS (AHC) controller programmed
W3224	ACS (AHC) calibration performed	W3905	Left joystick X-axis not in NEUTRAL
W3225	ACS (AHC) actuator calibration failed	W4005	Right joystick X-axis not in NEUTRAL
W3231	ACS (AHC) tilt actuator	W4007	Right joystick Y-axis not in NEUTRAL



**CONTROL PANEL SETUP**

**Right Panel Setup (Deluxe Instrumentation Panel)**

*Icon Identification*

**Figure 299**



ICON	DESCRIPTION
Mon, 17 Mar 3:45 PM	DATE / TIME
BRADY 232.5 hrs	USER / HOURMETER
Current Job 456.7 hrs	CURRENT JOB HOURS
	ACTIVE WARNINGS screen icon
	VITALS screen icon
	SERVICE screen icon
	MAIN screen icon
	ATTACHMENTS screen icon
	SECURITY screen icon
	DISPLAY screen icon
	HOME icon (Return to MAIN screen)
	LEFT SCROLL button
	RIGHT SCROLL button
<b>ENTER</b>	ENTER button

*Vitals*

	<p>Press a scroll button (Item 1) repeatedly until the Vitals screen icon (Inset) is highlighted.</p>
	<p>Displays select system operating levels.</p>

You can monitor real-time displays of:

- **Engine Speed**
- **Engine Oil Pressure**
- **Engine Coolant Temperature**
- **Fuel Consumption**
- **System Voltage**
- **Hydraulic Charge Pressure**
- **Hydraulic Fluid Temperature**
- **Engine Oil Temperature**

The Deluxe Instrumentation Panel is easy to use. Continue to set your own preferences for operating / monitoring your Bobcat loader.



**CONTROL PANEL SETUP (CONT'D)**

**Right Panel Setup (Deluxe Instrumentation Panel) (Cont'd)**

*Date And Time*

	<p>Press a scroll button (Item 1) repeatedly until the Display screen icon (Inset) is highlighted.</p>
	<p>Select <b>[1. CLOCKS]</b>.</p>
	<p>Select <b>[1. TIME]</b>.</p>
	<p>Use the keypad to enter time. Select AM / PM / 24hr. Press <b>[ENTER]</b> to continue.</p>
	<p>Select <b>[2. DATE]</b>.</p>
	<p>Use the keypad to enter date. Press <b>[ENTER]</b> to continue.</p>

*English / Metric Display*

	<p>Press a scroll button (Item 1) repeatedly until the Display screen icon (Inset) is highlighted.</p>
	<p>Select <b>[4. DISPLAY SETTINGS]</b>.</p>
	<p>Press <b>[1]</b> to cycle between ENGLISH and METRIC.</p>

*Auto Idle Time Delay*

	<p>Press a scroll button (Item 1) repeatedly until the Security screen icon (Inset) is highlighted.</p>
	<p>Select <b>[3. ENGINE SETTINGS]</b>.</p>
	<p>Use the keypad to enter the desired delay time between 4 and 250 seconds. Press <b>[ENTER]</b> to save and continue. Press left scroll button to exit without saving.</p>





**CONTROL PANEL SETUP (CONT'D)**

**Right Panel Setup (Deluxe Instrumentation Panel) (Cont'd)**

*Job Clock Reset*

	<p>Press a scroll button (Item 1) repeatedly until the Security screen icon (Inset) is highlighted.</p>
	<p>Select [1. PASSWORDS / LOCKOUTS].</p>
	<p>Enter owner password and press [ENTER].</p>
	<p>Select [1. USER SETTINGS].</p>
	<p>Select user.</p>
	<p>Select [3. RESET JOB STATISTICS].</p>
	<p>Press [9] to reset job statistics. Press left scroll button or [0] to exit without saving.</p>

*Machine Lockouts*

	<p>Press a scroll button (Item 1) repeatedly until the Security screen icon (Inset) is highlighted.</p>
	<p>Select [1. PASSWORDS / LOCKOUTS].</p>
	<p>Enter owner password and press [ENTER].</p>
	<p>Select [3. HIGH FLOW]. <b>OR</b> Select [4. TWO-SPEED].</p>
	<p><b>HIGH FLOW</b> Press user number to cycle between LOCKED and UNLOCKED.</p>
	<p><b>TWO-SPEED</b> Press user number to cycle between LOCKED and UNLOCKED.</p>

**NOTE: High-Flow and Two-Speed lockouts for the owner are active even if the Password Lockout feature is unlocked.**

## PASSWORD SETUP (KEYLESS START PANEL)

### Password Description

#### Master Password:

A permanent, randomly selected password set at the factory that cannot be changed. This password is used for service by the Bobcat dealer if the owner password is not known or to change the owner password.

#### Owner Password:

Allows for full use of the loader. Must be used to change the owner password.

### Changing The Owner Password

Turn the key switch to the RUN position to turn on the loaders electrical system.

Enter the five digit owner password using the number keys (1 through 0) if locked.

Figure 300



Press and hold the lock (Item 1) and unlock (Item 2) [Figure 300] keys for 2 seconds.

The lock key red light will flash and the left panel display screen will show [ENTER].

Enter a new five digit owner password using the number keys (1 through 0). An asterisk will show in the left panel display screen for each key press.

The left panel display screen will show [AGAIN].

Enter the new five digit owner password again.

The lock key red light will become solid.

### Password Lockout Feature

This feature allows the owner to unlock the password feature so that a password does not need to be used every time the engine is started.

Turn the key switch to the RUN position to turn on the loaders electrical system.

Enter the five digit owner password using the number keys (1 through 0).

Press the unlock key (Item 2) [Figure 300].

The left panel display screen will show [CODE].

Enter the five digit owner password using the number keys (1 through 0). The unlock key green light will flash, then become solid.

The loader can now be started without using a password.

**NOTE: Use the following procedure to reset the machine lock so that the loader requires a password to start the engine.**

Turn the key switch to the RUN position to turn on the loaders electrical system.

Press the lock key (Item 1) [Figure 300].

The lock key red light will flash and the left panel display screen will show [CODE].

Enter the five digit owner password using the number keys (1 through 0). The unlock key green light will flash, then the lock key red light will become solid.

You must now enter the password every time to start the loader.



**PASSWORD SETUP (DELUXE INSTRUMENTATION PANEL)**

**Password Description**

All new machines with a Deluxe Instrumentation Panel arrive at Bobcat dealerships with the keypad in locked mode. Locked mode means that a password must be used to start the engine.

For security purposes, your dealer may change the password and set the keypad in the locked mode. Your dealer will provide you with the password.

**Master Password:**

A permanent, randomly selected password set at the factory that cannot be changed. This password is used for service by the Bobcat dealer if the owner password is not known or to change the owner password.

**Owner Password:**

Allows for full use of the loader and to set up the Deluxe Instrumentation Panel. There is only one owner password. The owner password must be used to change the owner or user passwords. Owner should change the password as soon as possible for security of the loader.

**User Password:**

Allows starting and operating the loader; cannot change passwords or lockout features.

For the procedures to change passwords: (See Changing The Owner Password on Page 209.) and (See Changing The User Passwords on Page 210.)

**Changing The Owner Password**

	<p>Press a scroll button (Item 1) repeatedly until the Security screen icon (Inset) is highlighted.</p>
	<p>Select [1. PASSWORDS / LOCKOUTS].</p>
	<p>Enter owner password and press [ENTER].</p>
	<p>Select [1. USER SETTINGS].</p>
	<p>Select [1. OWNER].</p>
	<p>Select [2. CHANGE PASSWORD].</p>
	<p>Enter new owner password and press [ENTER].  You will be prompted to reenter the new owner password.</p>

PASSWORD SETUP (DELUXE INSTRUMENTATION PANEL) (CONT'D)

Changing The User Passwords

	<p>Press a scroll button (Item 1) repeatedly until the Security screen icon (Inset) is highlighted.</p>
	<p>Select [1. PASSWORDS / LOCKOUTS].</p>
	<p>Enter owner password and press [ENTER].</p>
	<p>Select [1. USER SETTINGS].</p>
	<p>Select user.</p>
	<p>Select [2. CHANGE PASSWORD].</p>
	<p>Enter new user password and press [ENTER].</p>

Password Lockout Feature

This feature allows the owner to unlock the password feature so that a password does not need to be used every time the engine is started.

	<p>Press a scroll button (Item 1) repeatedly until the Security screen icon (Inset) is highlighted.</p>
	<p>Select [1. PASSWORDS / LOCKOUTS].</p>
	<p>Enter owner password and press [ENTER].</p>
	<p>Select [2. MACHINE LOCK].</p>

**NOTE:** The procedure above can be followed to reset the machine lock so that the machine requires a password to start the engine.

## MAINTENANCE CLOCK

### Description

The Maintenance Clock alerts the operator when the next service interval is due. *EXAMPLE:* The maintenance clock can be set to a 500 hour interval as a reminder for the next 500 hour planned maintenance.

Figure 301

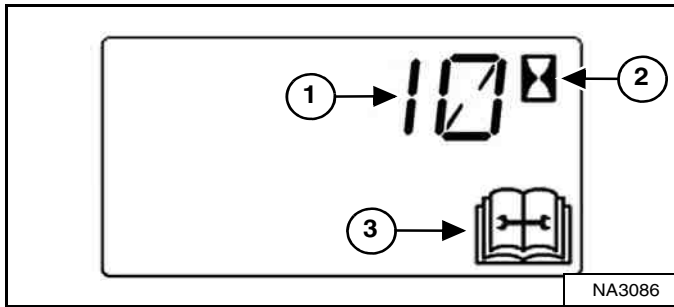

During machine operation, a 2 beep alarm will sound when there are less than 10 hours until the next planned maintenance.

The remaining hours before maintenance is required (Item 1) will appear in the data display for 5 seconds while the service icon (Item 3) and the hourmeter icon (Item 2) [Figure 301] flash.

**NOTE: The display will show negative numbers after counting down to zero.**

The display will revert to the previous display and will appear for 5 seconds every time the machine is started until the maintenance clock is reset.

Figure 302



The Deluxe Instrumentation Panel (if equipped) will display a message (Item 1) [Figure 302] alerting the operator to service the machine.

This message will appear for 10 seconds every time the machine is started until the maintenance clock is reset.

Figure 303



The Deluxe Instrumentation Panel (if equipped) will display a bar (Item 1) [Figure 303] showing the time remaining until next service. This bar will turn red when service is past due. [NEXT MAINTENANCE DUE] will change to [MAINTENANCE PAST DUE] and display the number of hours past due.

Keys [4] and [9] can be used to adjust the service interval when the owner is logged in [Figure 303].

### Setup

See your Bobcat dealer about installation of this feature.

### Reset

See your Bobcat dealer to reset the maintenance clock.



## SPECIFICATIONS

LOADER SPECIFICATIONS .....	.213
Machine Dimensions .....	.213
Performance .....	.214
Engine .....	.214
Drive System .....	.215
Controls .....	.215
Hydraulic System .....	.216
Electrical System .....	.217
Capacities .....	.217
Tracks .....	.218
Ground Pressure .....	.218
Environmental .....	.218
Temperature Range .....	.218

Certain specification(s) are based on engineering calculations and are not actual measurements. Specification(s) are provided for comparison purposes only and are subject to change without notice. Specification(s) for your individual Bobcat equipment will vary based on normal variations in design, manufacturing, operating conditions, and other factors.

## LOADER SPECIFICATIONS

### Machine Dimensions

- Dimensions are given for loader equipped with standard track and 84 in. Heavy Duty Construction and Industrial bucket and may vary with other bucket types.
- Where applicable, specifications conform to SAE or ISO standards and are subject to change without notice.

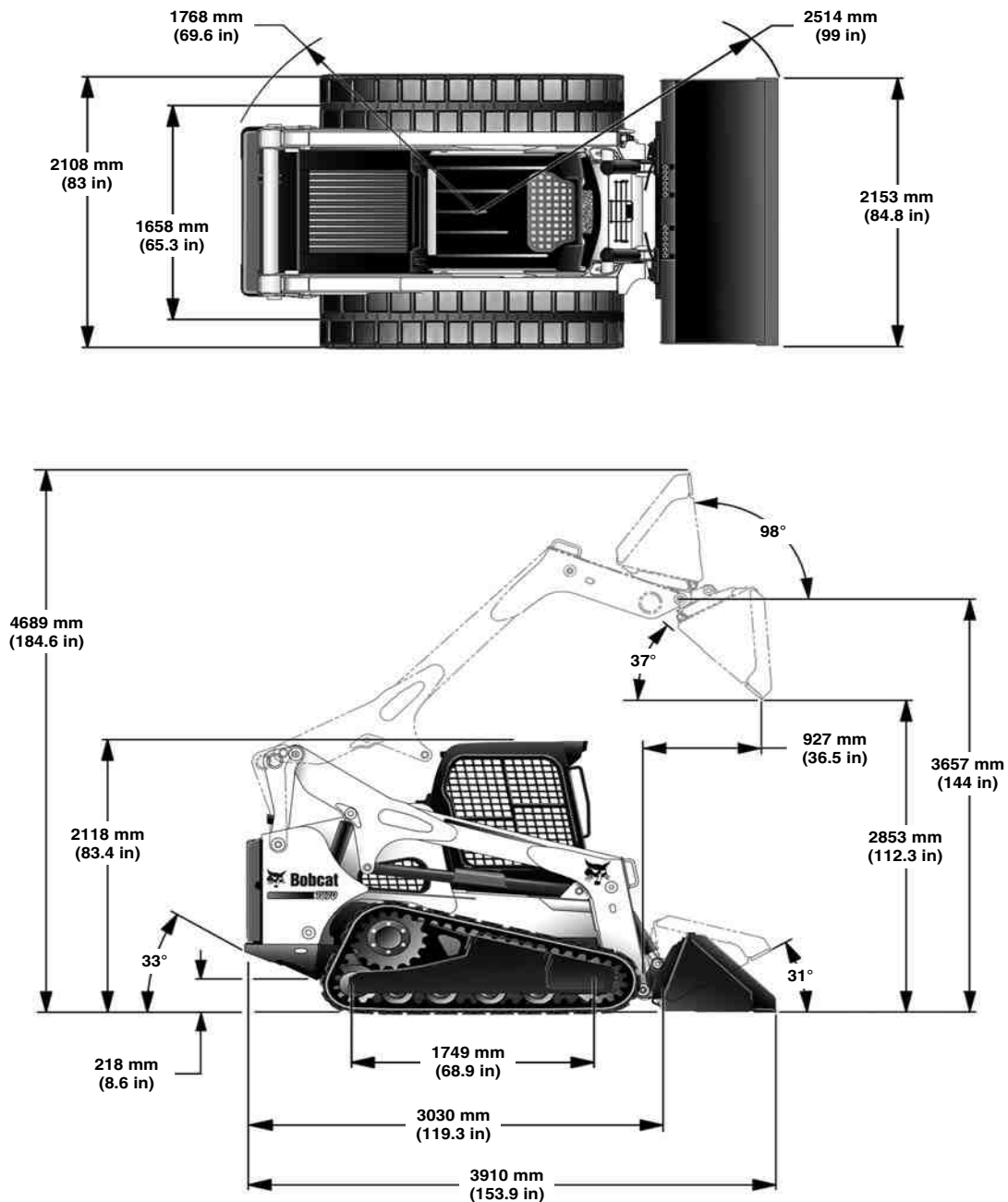

NA9524

Changes of structure or weight distribution of the loader can cause changes in control and steering response, and can cause failure of the loader parts.



**LOADER SPECIFICATIONS (CONT'D)**

**Performance**

Rated Operating Capacity (ISO 14397-1)	1650 kg (3638 lb)
with 200 Pound Frame Mounted Counterweight Kit (ISO 14397-1)	1696 kg (3738 lb)
with 300 Pound Frame Mounted Counterweight Kit (ISO 14397-1)	1730 kg (3813 lb)
with 400 Pound Frame Mounted Counterweight Kit (ISO 14397-1)	1764 kg (3888 lb)
Tipping Load (ISO 14397-1)	4716 kg (10396 lb)
Operating Weight	5863 kg (12925 lb)
Breakout Force – Lift	3230 kg (7121 lb)
Breakout Force – Tilt	3692 kg (8139 lb)
Travel Speed:	
Low Range	0 – 10,5 km/h (0 – 6.5 mph)
High Range	0 – 18,3 km/h (0 – 11.4 mph)

**Engine**

Make / Model	Bobcat Engine / 3,4L Bobcat Engine Stage IV
Fuel / Cooling	Diesel / Liquid
Horsepower:	
– ISO 9249 EEC / SAE J1349 Net	71,5 kW (95.9 hp) @ 2400 rpm
– ISO 14396 Gross	74,6 kW (100.1 hp) @ 2400 rpm
– SAE J1995 Gross	75,6 kW (101.4 hp) @ 2400 rpm
– Rated Power	74,6 kW (100.0 hp) @ 2400 rpm
Torque:	
– ISO 9249 EEC / SAE J1349 Net	355,8 N•m (262.4 ft-lb) @ 1600 rpm
– ISO 14396 Gross	375,4 N•m (276.9 ft-lb) @ 1600 rpm
– SAE J1995 Gross	380,3 N•m (280.5 ft-lb) @ 1600 rpm
– Rated Torque	375,0 N•m (276.6 ft-lb) @ 1600 rpm
Low Idle rpm	1050
High Idle rpm	2400
Number of Cylinders	4
Displacement	3409 cm <sup>3</sup> (208.0 in <sup>3</sup> )
Bore / Stroke	98 mm / 113 mm (3.86 in / 4.45 in)
Lubrication	Gear Pump Pressure System with Filter
Crankcase Ventilation	Closed Breathing
Air Cleaner	Dry replaceable paper cartridge with separate safety element
Ignition	Diesel – Compression
Air Induction	Turbo-Charged and Charged Air Cooled
Engine Coolant	Propylene Glycol / Water Mixture
Starting Aid	Air intake heater automatically activated as needed in RUN position





**LOADER SPECIFICATIONS (CONT'D)**

**Drive System**

Main Drive	Fully hydrostatic, rubber track drive
Transmission	Infinitely variable tandem hydrostatic piston pumps, driving two fully reversing hydrostatic motors
Tracks (Tension)	Grease cylinder and spring

**Controls**

Machine Steering	Direction and speed controlled by hand operated joystick(s)
Loader Hydraulics: – Lift and Tilt – Front Auxiliary – Rear Auxiliary (Option)	Controlled by hand operated joystick(s) Controlled by electrical switch on Right Hand joystick Controlled by electrical switch on Left Hand joystick
Auxiliary Pressure Release	Pressure relieved through quick couplers; Push couplers in, hold for 5 seconds
Engine	Hand operated speed control, additional foot operated speed control pedal; key-type start switch or optional Keyless Start Panel or optional Deluxe Instrumentation Panel and function error shutdown
Service Brake	Two independent hydrostatic systems controlled by two hand operated steering levers or optional joystick(s)
Secondary Brake	One of the hydrostatic transmissions
Parking Brake (Standard)	Spring applied pressure release multi-disc brake activated by manually operated switch on left instrument panel



**LOADER SPECIFICATIONS (CONT'D)**

**Hydraulic System**

Pump Type	Engine driven, gear type
Pump Capacity – Standard-Flow	87,1 L/min (23.0 U.S. gpm)
Pump Capacity – High-Flow (Option)	138,2 L/min (36.6 U.S. gpm)
System Relief at Quick Couplers	27,2 – 27,9 MPa (272 – 279 bar) (3950 – 4050 psi)
Filter (Hydraulic / Hydrostatic)	Replaceable beta 10 micron = 200, drop in element
Filter (Charge)	Replaceable beta 10 micron = 200, spin-on element
Hydraulic Cylinders:	Double-acting; lift cylinders have cushioning feature on lower, tilt cylinders have cushioning feature on dump and rollback
Lift Cylinder (2):	
Bore Diameter	88,9 mm (3.50 in)
Rod Diameter	50,8 mm (2.00 in)
Stroke	698,75 mm (27.51 in)
Tilt Cylinder (2):	
Bore Diameter	82,6 mm (3.25 in)
Rod Diameter	38,1 mm (1.50 in)
Stroke	388,36 mm (15.29 in)
Control Valve	3-Spool, open centre with electric actuator controlled lift with float and tilt; Electrically controlled auxiliary spool
Fluid Lines	SAE Standard tubelines, hoses, and fittings
Hydraulic Function Time:	
Raise Lift Arms	5.9 seconds
Lower Lift Arms	4.0 seconds
Bucket Dump	2.9 seconds
Bucket Rollback	2.3 seconds



**LOADER SPECIFICATIONS (CONT'D)**

**Electrical System**

Alternator	Belt driven, 120 amperes, open frame
Battery	12 volt, 1000 cold cranking amperes @ -18°C (0°F), 186 minute reserve capacity @ 25 amperes
Starter	12 volt, gear type, 2,7 kW (3.62 hp)
Instrumentation	<p style="text-align: center;"><b>Gauges:</b></p> <p style="text-align: center;">Engine Coolant Temperature and Fuel Level</p> <p style="text-align: center;"><b>Warning lights:</b></p> <p style="text-align: center;">Fuel Level, Seat Belt, Engine Coolant Temperature, Engine Malfunction, Hydraulic System Malfunction, Diesel Exhaust Fluid (DEF) / AdBlue®, and General Warning</p> <p style="text-align: center;"><b>Indicators:</b></p> <p style="text-align: center;">Diesel Exhaust Fluid (DEF) / AdBlue® Level, BICS™ Functions, Two-Speed, 3- Point Restraint, and Turn Signals</p> <p style="text-align: center;"><b>Data Display:</b></p> <p style="text-align: center;">Operating Hours, Engine rpm, Speed Management Setting, Maintenance Clock Countdown, Battery Voltage, Service Codes, Engine Preheat Countdown, Lift and Tilt Compensation Setting, Steering Drift Compensation Setting, and Drive Response Setting</p> <p style="text-align: center;"><b>Other:</b></p> <p style="text-align: center;">Audible Alarm, Lights, and Option / Accessory Switches</p> <p style="text-align: center;"><b>Optional Deluxe Instrumentation Panel:</b></p> <p style="text-align: center;">*Additional displays for: Engine rpm, Engine Coolant Temperature, Engine Oil Pressure, System Voltage, Hydraulic Fluid Temperature, and Hydrostatic Charge Pressure</p> <p style="text-align: center;">*Additional Features Included: Keyless Start, Digital Clock, Job Clock, Password Lockout, Multiple-Language Display, Help Screens, Diagnostic Capability, and Engine / Hydraulic Systems Shutdown Function</p>

**Capacities**

Fuel	122,3 L (32.3 U.S. gal)
Engine Oil with Filter Change	12,6 L (13.3 qt)
Engine Cooling System with Heater	14,4 L (3.8 U.S. gal)
Engine Cooling System without Heater	13,6 L (3.6 U.S. gal)
Hydraulic / Hydrostatic Reservoir	9,5 L (2.5 U.S. gal)
Hydraulic / Hydrostatic System	45,4 L (12.0 U.S. gal)
Diesel Exhaust Fluid (DEF) / AdBlue®	25,7 L (6.8 U.S. gal)
Hydrostatic Drive Motor (Each)	180,0 mL (6.1 U.S. fl oz)
Air Conditioning Refrigerant (R-134a)	0,68 kg (1.5 lb)



**LOADER SPECIFICATIONS (CONT'D)**

**Tracks**

Standard	450 mm (17.7 in) Rubber
----------	-------------------------

**Ground Pressure**

Rubber Track – 450 mm (17.7 in)	0,033 MPa (0,33 bar) (4.9 psi)
---------------------------------	--------------------------------

**Environmental**

DECLARED SINGLE-NUMBER NOISE EMISSION VALUES In accordance with ISO 4871	
Noise level per Directive 2000/14/EC — $L_{WA}$	104 dB(A)
Operator noise level per Directive 2006/42/EC — $L_{pA}$	83 dB(A)

DECLARED VIBRATION EMISSION VALUES In accordance with EN 12096		
	Value	Uncertainty
Whole-body vibration per ISO 2631-1	1,11 $m/s^2$	0,44 $m/s^2$
Hand-arm vibration per ISO 5349-1	2,65 $m/s^2$	1,33 $m/s^2$

Machine equipped with optional HVAC (air condition) contains fluorinated greenhouse gas (F-gas)	
F-gas type	HFC-134a
F-gas mass (kg)	0.68
CO2 equivalent (t)	0.97
GWP	1430

**Temperature Range**

Operation and storage	-26 – +43°C (-15 – +110°F)
-----------------------	----------------------------



## WARRANTY

WARRANTY ..... 220



WARRANTY

# WARRANTY

## BOBCAT LOADERS

Doosan Bobcat EMEA s.r.o. ("Doosan") warrants to its authorized dealers who in turn warrants to the customer that each new Bobcat Loader will be free from defects in material and workmanship for twelve (12) months from the date of delivery to the customer or 2000 hours of machine usage, whichever occurs first. During the warranty period, the authorized Doosan dealer shall repair or replace, at Doosan's option, without charge for parts, labour and travel of technicians, any part of the Doosan product which fails because of defects in material or workmanship. The customer shall provide the authorized Doosan dealer with prompt written notice of the defect and allow reasonable time for replacement or repair. Doosan may, at its option, request failed parts to be returned to the factory or to any other designated location. Transportation of the Doosan product to the authorized Doosan dealer for warranty work is not the responsibility of Doosan. Service schedules must adhere to prescribed intervals and Bobcat genuine parts/lubricants must be used. The warranty does not apply to tyres, tracks or other accessories not manufactured by Doosan. For coverage on engines, consult with your Bobcat Dealer. For these non-covered items, the customer shall refer solely to the warranty, if any, of the respective manufacturers thereof, in accordance with the respective manufacturers warranty statement. Some Doosan parts are covered pro-rata depending on the expected life-time of the part. Coverage for batteries, air-conditioning refill, couplers and ignition system parts (glow plugs, fuel injection pumps, injectors) is reduced as failures generally originate from factors not under Doosan's control such as, but not limited to, prolonged storage, abuse or fuel quality. Reduced coverage is, depending on the component, limited from 50 to 500 operating hours. The warranty does not cover: (i) Oils and lubricants, coolant fluids, filter elements, brake linings, tune-up parts, bulbs, fuses, alternator fan belts, drive belts, pins, bushings and other high-wear items. (ii) Damages resulting from abuse, accidents, alterations, use of the product with any bucket or attachment not approved by Doosan, air flow obstructions, or failure to maintain or use the Doosan product according to the instructions applicable to it. (iii) Ground engaging parts such as bucket teeth and cutting edges. (iv) Fuel or hydraulic system cleaning, engine tune-up, brake inspection or adjustment. (v) Adjustments or slight defects which generally do not affect the stability or reliability of the machine.

DOOSAN EXCLUDES OTHER CONDITIONS, WARRANTIES OR REPRESENTATIONS OF ALL KINDS, EXPRESSED OR IMPLIED, STATUTORY OR OTHERWISE (EXCEPT THAT OF TITLE) INCLUDING ALL IMPLIED WARRANTIES AND CONDITIONS RELATING TO MERCHANTABILITY, SATISFACTORY QUALITY AND FITNESS FOR A PARTICULAR PURPOSE. CORRECTIONS BY DOOSAN OF NONCONFORMITIES WHETHER PATENT OR LATENT, IN THE MANNER AND FOR THE TIME PERIOD PROVIDED ABOVE, SHALL CONSTITUTE FULFILLMENT OF ALL LIABILITIES OF DOOSAN FOR SUCH NONCONFORMITIES, WHETHER BASED ON CONTRACT, WARRANTY, TORT, NEGLIGENCE, INDEMNITY, STRICT LIABILITY OR OTHERWISE WITH RESPECT TO OR ARISING OUT OF SUCH PRODUCT. THE REMEDIES OF THE END-USER/OWNER SET FORTH UNDER THE PROVISIONS OF THE WARRANTY OUTLINED ABOVE ARE EXCLUSIVE AND THE TOTAL LIABILITY OF DOOSAN INCLUDING ANY HOLDING, SUBSIDIARY, ASSOCIATED OR AFFILIATED COMPANY OR DISTRIBUTOR WITH RESPECT TO THIS SALE OR THE PRODUCT AND SERVICE FURNISHED HEREUNDER IN CONNECTION WITH THE PERFORMANCE OR BREACH THEREOF, OR FROM DELIVERY, INSTALLATION, REPAIR OR TECHNICAL DIRECTION COVERED BY OR FURNISHED UNDER THIS SALE, WHETHER BASED ON CONTRACT, WARRANTY, TORT, NEGLIGENCE, INDEMNITY, STRICT LIABILITY OR OTHERWISE SHALL NOT EXCEED THE PURCHASE PRICE OF THE PRODUCT UPON WHICH SUCH LIABILITY IS BASED. DOOSAN INCLUDING ANY HOLDING, SUBSIDIARY, ASSOCIATED OR AFFILIATED COMPANY AND DISTRIBUTOR SHALL IN NO EVENT BE LIABLE TO THE END-USER/OWNER, ANY SUCCESSORS IN INTEREST OR ANY BENEFICIARY OR ASSIGNEE RELATING TO THIS SALE FOR ANY CONSEQUENTIAL, INCIDENTAL, INDIRECT, SPECIAL OR PUNITIVE DAMAGES ARISING OUT OF THIS SALE OR BY ANY BREACH THEREOF, OR ANY DEFECT IN, OR FAILURE OF, OR MALFUNCTION OF THE PRODUCT UNDER THIS SALE, WHETHER BASED UPON LOSS OF USE, LOST PROFITS OR REVENUE, INTEREST, LOST GOODWILL, WORK STOPPAGE, IMPAIRMENT OF OTHER GOODS, LOSS BY REASON OF SHUTDOWN OR NON-OPERATION, INCREASED EXPENSES OF OPERATION OR CLAIMS OF USER OR CUSTOMERS OF THE USER FOR SERVICE INTERRUPTION WHETHER OR NOT SUCH LOSS OR DAMAGE IS BASED ON CONTRACT, WARRANTY, TORT, NEGLIGENCE, INDEMNITY, STRICT LIABILITY OR OTHERWISE.





# WARRANTY

## BOBCAT TRACK WARRANTY

Every new rubber track is warranted to be free of defects in material and workmanship for the life of the original tread design within the limits of the normal warranty conditions.

Original tread life is considered completed when the track has 10 percent or less of remaining tread in any position of its original tread depth, in any portion of its original tread design.

If upon presentation of the track to the authorised Bobcat representative, the representative determines the warranty claim is valid during the first 10 percent of tread life, DOOSAN BENELUX S.A. and the authorised dealer will supply a comparable new track at no charge. If the warranty claim is granted after the first 10 percent of tread life of the track has worn away, but before the original tread life is completed, the original buyer will receive a pro-rata replacement credit toward the purchase of a comparable new track, relative to the unused portion of the tread on the original track based on a predetermined schedule in effect at the time of replacement. The end-user/owner pays all applicable taxes and disposal costs relating to the replacement.

This warranty only applies when the track is installed on the approved recommended Bobcat product. This warranty does not cover track failures as a result of tears, cuts, fire or vandalism, damaged or broken cords due to improper adjustment, age conditions such as cracks, and extreme temperature exposure.

This warranty is solely for the benefit of the end-user/owner of the track and is not assignable.

DOOSAN BENELUX S.A. EXCLUDES OTHER CONDITIONS, WARRANTIES OR REPRESENTATIONS OF ALL KINDS, EXPRESSED OR IMPLIED, STATUTORY OR OTHERWISE (EXCEPT THAT OF TITLE) INCLUDING ALL IMPLIED WARRANTIES AND CONDITIONS RELATING TO MERCHANTABILITY, SATISFACTORY QUALITY AND FITNESS FOR A PARTICULAR PURPOSE.

CORRECTIONS BY DOOSAN BENELUX S.A. OF NONCONFORMITIES WHETHER PATENT OR LATENT, IN THE MANNER AND FOR THE TIME PERIOD PROVIDED ABOVE, SHALL CONSTITUTE FULFILMENT OF ALL LIABILITIES OF DOOSAN BENELUX S.A. FOR SUCH NONCONFORMITIES, WHETHER BASED ON CONTRACT, WARRANTY, TORT, NEGLIGENCE, INDEMNITY, STRICT LIABILITY OR OTHERWISE WITH RESPECT TO OR ARISING OUT OF SUCH PRODUCT.

THE REMEDIES OF THE END-USER/OWNER SET FORTH UNDER THE PROVISIONS OF THE WARRANTY OUTLINED ABOVE ARE EXCLUSIVE AND THE TOTAL LIABILITY OF DOOSAN BENELUX S.A. INCLUDING ANY HOLDING, SUBSIDIARY, ASSOCIATED OR AFFILIATED COMPANY OR DISTRIBUTOR WITH RESPECT TO THIS SALE OR THE PRODUCT AND SERVICE FURNISHED HEREUNDER IN CONNECTION WITH THE PERFORMANCE OR BREACH THEREOF, OR FROM DELIVERY, INSTALLATION, REPAIR OR TECHNICAL DIRECTION COVERED BY OR FURNISHED UNDER THIS SALE, WHETHER BASED ON CONTRACT, WARRANTY, TORT, NEGLIGENCE, INDEMNITY, STRICT LIABILITY OR OTHERWISE SHALL NOT EXCEED THE PURCHASE PRICE OF THE PRODUCT UPON WHICH SUCH LIABILITY IS BASED.

DOOSAN BENELUX S.A. INCLUDING ANY HOLDING, SUBSIDIARY, ASSOCIATED OR AFFILIATED COMPANY AND DISTRIBUTOR SHALL IN NO EVENT BE LIABLE TO THE END-USER/OWNER, ANY SUCCESSORS IN INTEREST OR ANY BENEFICIARY OR ASSIGNEE RELATING TO THIS SALE FOR ANY CONSEQUENTIAL, INCIDENTAL, INDIRECT, SPECIAL OR PUNITIVE DAMAGES ARISING OUT OF THIS SALE OR BY ANY BREACH THEREOF, OR ANY DEFECT IN, OR FAILURE OF, OR MALFUNCTION OF THE PRODUCT UNDER THIS SALE, WHETHER BASED UPON LOSS OF USE, LOST PROFITS OR REVENUE, INTEREST, LOST GOODWILL, WORK STOPPAGE, IMPAIRMENT OF OTHER GOODS, LOSS BY REASON OF SHUTDOWN OR NON-OPERATION, INCREASED EXPENSES OF OPERATION OR CLAIMS OF USER OR CUSTOMERS OF THE USER FOR SERVICE INTERRUPTION WHETHER OR NOT SUCH LOSS OR DAMAGE IS BASED ON CONTRACT, WARRANTY, TORT, NEGLIGENCE, INDEMNITY, STRICT LIABILITY OR OTHERWISE.

THIS WARRANTY IS IN LIEU OF ALL OTHER WARRANTIES (EXCEPT THOSE OF TITLE), EXPRESSED OR IMPLIED, AND THERE ARE NO WARRANTIES OF MERCHANTABILITY OR FITNESS FOR A PARTICULAR PURPOSE. IN NO EVENT SHALL THE AUTHORISED SELLING DEALER OR BOBCAT COMPANY BE LIABLE FOR DOWNTIME EXPENSES, LOSS OF MACHINE USE OR OTHER INCIDENTAL, CONSEQUENTIAL OR SPECIAL DAMAGES. THIS WARRANTY IS EXCLUSIVE AND IN LIEU OF ALL OTHER WARRANTIES AND CONDITIONS, EXCEPT THE WARRANTY OF TITLE. BOBCAT COMPANY DISCLAIMS ALL OTHER WARRANTIES AND CONDITIONS, EXPRESS OR IMPLIED, INCLUDING ANY IMPLIED WARRANTIES OR CONDITIONS OF MERCHANTABILITY OR FITNESS FOR A PARTICULAR PURPOSE. IN NO EVENT SHALL BOBCAT COMPANY OR THE AUTHORISED BOBCAT DEALER BE LIABLE FOR ANY SPECIAL, INCIDENTAL, INDIRECT OR CONSEQUENTIAL DAMAGES WHATSOEVER, INCLUDING, BUT NOT LIMITED TO, LOSS OR INTERRUPTION OF BUSINESS, LOST PROFITS, OR LOSS OF MACHINE USE, WHETHER BASED ON CONTRACT, WARRANTY, TORT, NEGLIGENCE, STRICT LIABILITY, STATUTE OR OTHERWISE, EVEN IF BOBCAT COMPANY OR THE AUTHORISED BOBCAT DEALER HAS BEEN ADVISED OF THE POSSIBILITY OF SUCH DAMAGES. THE TOTAL LIABILITY OF BOBCAT EUROPE AND THE AUTHORISED BOBCAT DEALERS WITH RESPECT TO THE PRODUCT AND SERVICES FURNISHED HEREUNDER SHALL NOT EXCEED THE PURCHASE PRICE OF THE PRODUCT UPON WHICH SUCH LIABILITY IS BASED.



**Bobcat** <sup>®</sup>



**ALPHABETICAL INDEX**

AIR CONDITIONING BELT .....	176	LIFT ARM BYPASS CONTROL .....	61
ALTERNATOR BELT .....	175	LIFT ARM SUPPORT DEVICE .....	129
ATTACHMENT CONTROL DEVICE (ACD) ..	88	LIFTING THE LOADER .....	116
ATTACHMENTS .....	105	LOADER IDENTIFICATION .....	8
AUTO IDLE .....	60	LOADER SPECIFICATIONS .....	213
AUTOMATIC RIDE CONTROL ACCUMULATOR .....	181	LOADER STORAGE AND RETURN TO SERVICE .....	188
BACK-UP ALARM SYSTEM .....	132	LUBRICATING THE LOADER .....	182
BACK-UP ALARM SYSTEM .....	65	MACHINE SIGNS (DECALS) .....	19
BOBCAT COMPANY IS ISO 9001 CERTIFIED .....	5	MAINTENANCE CLOCK .....	211
BOBCAT INTERLOCK CONTROL SYSTEM (BICS™) .....	126	MAINTENANCE SAFETY .....	122
BOBCAT INTERLOCK CONTROL SYSTEM (BICS™) .....	51	MONITORING THE DISPLAY PANELS ...	102
BOB-TACH (HAND LEVER) .....	186	OPERATING PROCEDURE .....	114
BOB-TACH (POWER) .....	187	OPERATOR CAB .....	133
CONTROL IDENTIFICATION .....	48	OPERATOR CAB .....	49
CONTROL PANEL SETUP .....	205	OPERATOR SAFETY WARNINGS .....	1
COUNTERWEIGHTS .....	104	PARKING BRAKE .....	59
DAILY INSPECTION .....	89	PASSWORD SETUP (DELUXE INSTRUMENTATION PANEL) .....	209
DECLARATION OF CONFORMITY .....	3	PASSWORD SETUP (KEYLESS START PANEL) .....	208
DELIVERY REPORT .....	7	PIVOT PINS .....	185
DIAGNOSTIC SERVICE CODES .....	190	PRE-STARTING PROCEDURE .....	91
DIESEL EXHAUST FLUID (DEF) / ADBLUE® SYSTEM .....	147	PUBLICATIONS AND TRAINING RESOURCES .....	18
DRIVE BELT .....	178	REAR DOOR (TAILGATE) .....	136
DRIVE RESPONSE .....	72	REAR GRILLE .....	137
DRIVING AND STEERING THE LOADER ..	66	REGULAR MAINTENANCE ITEMS .....	5
ELECTRICAL SYSTEM .....	157	SAFETY INSTRUCTIONS .....	14
EMERGENCY EXIT .....	62	SEAT BAR RESTRAINT SYSTEM .....	127
ENGINE AIR CLEANER .....	141	SEAT BAR RESTRAINT SYSTEM .....	52
ENGINE COOLING SYSTEM .....	151	SEAT BELT .....	128
ENGINE LUBRICATION SYSTEM .....	148	SELECTIVE CATALYTIC REDUCTION (SCR) SYSTEM .....	53
ENGINE SPEED CONTROL .....	60	SERIAL NUMBER LOCATIONS .....	7
FEATURES, ACCESSORIES, AND ATTACHMENTS .....	9	SERVICE SCHEDULE .....	123
FIRE PREVENTION .....	16	SPEED MANAGEMENT .....	70
FUEL SYSTEM .....	143	STARTING THE ENGINE .....	95
HEATING, VENTILATION, AND AIR CONDITIONING (HVAC) SYSTEM .....	138	STEERING DRIFT COMPENSATION .....	74
HYDRAULIC / HYDROSTATIC SYSTEM ..	165	STOPPING THE ENGINE AND LEAVING THE LOADER .....	103
HYDRAULIC CONTROLS .....	78	STOPPING THE LOADER .....	68
HYDROSTATIC DRIVE MOTOR .....	174	TOWING THE LOADER .....	116
INSTRUMENT PANEL IDENTIFICATION ..	37	TRACK ROLLER AND IDLER LUBRICATION .....	185
INTENDED USE .....	36	TRACK SPROCKET MAINTENANCE ...	174
LIFT AND TILT COMPENSATION .....	76	TRACK TENSION .....	171





TRACK UNDERCARRIAGE SYSTEM . . .	112
TRACTION LOCK OVERRIDE . . . . .	59
TRANSPORTING THE LOADER ON A TRAILER . . . . .	118
TWO-SPEED CONTROL . . . . .	69
WARRANTY . . . . .	220









