



**KEEP FOR FUTURE REFERENCE**



**P.O. Box 368 – 908 West Main  
Laurel, MT USA 59044  
phone 800-548-7341  
phone 406-628-8231  
fax 406-628-8354**

# OPERATING INSTRUCTIONS



MODEL NUMBERS: MRTA811LDC2  
MRTA8FS10TDC2, MRTA810DC2  
SERIAL NUMBER: \_\_\_\_\_  
(please see serial label and record number here)

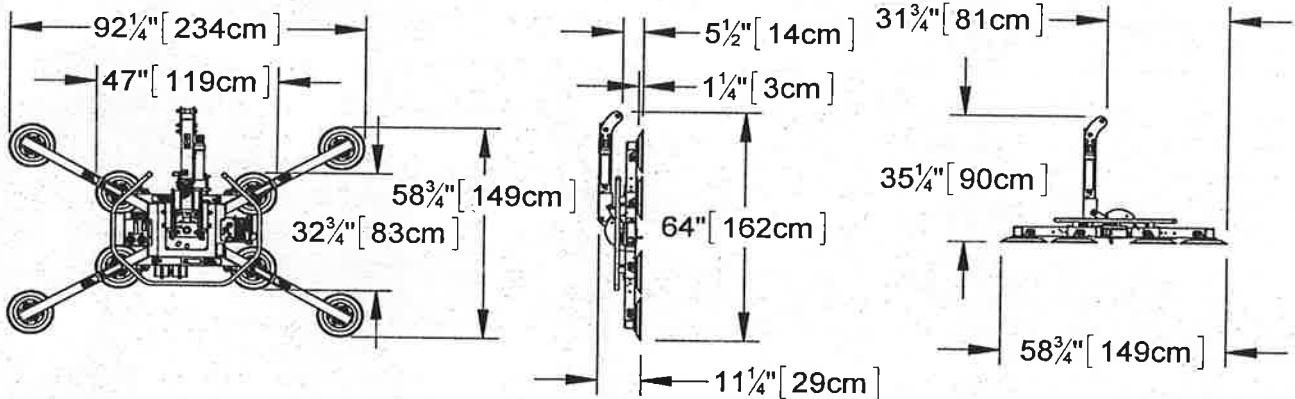

MRTA811LDC2 shown

**QUADRA-TILT ROTATOR  
DC-VOLTAGE  
WITH DUAL VACUUM SYSTEM  
(AVAILABLE WITH REMOTE CONTROL SYSTEM)**



**READ ALL INSTRUCTIONS AND SAFETY RULES  
BEFORE OPERATING THIS LIFTER**



**DESIGNED FOR THE MATERIALS HANDLING PROFESSIONAL**



# TABLE OF CONTENTS

<b>SPECIFICATIONS .....</b>	<b>3</b>
<b>SAFETY .....</b>	<b>4</b>
<b>OPERATING FEATURES .....</b>	<b>5</b>
<b>ASSEMBLY .....</b>	<b>7</b>
<b>TO CHANGE THE PAD FRAME CONFIGURATION .....</b>	<b>10</b>
To Connect/Disconnect Vacuum Hoses .....	11
To Install/Remove Extension Arms and Reposition Vacuum Pads .....	12
About Secondary Rotation Stops .....	13
<b>INTENDED USE .....</b>	<b>14</b>
<b>LOAD CHARACTERISTICS .....</b>	<b>14</b>
<b>OPERATING ENVIRONMENT .....</b>	<b>15</b>
<b>DISPOSAL OF THE LIFTER .....</b>	<b>15</b>
<b>OPERATION .....</b>	<b>16</b>
<b>BEFORE USING THE LIFTER .....</b>	<b>16</b>
Taking Safety Precautions .....	16
Performing Inspections and Tests .....	16
Preparing to Use the Optional Remote Control System .....	18
<b>TO APPLY THE PADS TO A LOAD .....</b>	<b>19</b>
Positioning the Lifter on the Load .....	19
Powering up the Lifter .....	20
Sealing the Pads against the Load .....	21
Reading the Vacuum Gauges .....	22
Vacuum Level on Optimal Surfaces .....	22
Vacuum Level on Other Surfaces .....	22
<b>TO LIFT AND MOVE THE LOAD .....</b>	<b>23</b>
About the Tilt Linkage .....	23
Engaging or Disengaging Tilt Locks .....	23
Interpreting the Warning Buzzer and Lift Light .....	24
Monitoring Vacuum Indicators .....	24
Controlling the Lifter and Load .....	25
In Case of Power Failure .....	25
<b>TO ROTATE THE LOAD EDGEWISE .....</b>	<b>26</b>
<b>TO TILT THE LOAD .....</b>	<b>27</b>
<b>TO RELEASE THE PADS FROM THE LOAD .....</b>	<b>28</b>
<b>AFTER USING THE LIFTER .....</b>	<b>29</b>
Storing the Lifter .....	29
<b>MAINTENANCE FEATURES .....</b>	<b>30</b>
<b>MAINTENANCE .....</b>	<b>31</b>
<b>INSPECTION SCHEDULE .....</b>	<b>31</b>
Infrequent Use .....	32



**TESTING SCHEDULE .....32**  
 Operational Tests..... 32  
 Load Test..... 32

**BATTERY TEST .....33**

**BATTERY RECHARGE .....34**

**POWER LOSS WARNING BUZZER TEST .....34**

**VACUUM PAD MAINTENANCE .....35**  
 Pad to Load Friction Coefficient..... 35  
 Pad Inspection..... 35  
 Pad Cleaning..... 35

**VACUUM TEST .....36**

**REMOTE CONTROL SYSTEM TEST .....37**

**TO REPLACE SEALING RING INSERT IN VACUUM PAD .....38**

**REPLACEMENT PARTS LIST ..... 39**

**LIMITED WARRANTY..... 40**



# SPECIFICATIONS

<b>Description:</b> 	Designed for use with a crane or other hoisting equipment, MRTA8-DC2 lifters employ vacuum to hold a load for lifting, and they provide manual 360° rotation and mechanically assisted, manual 90° tilt movements for load manipulation.		
<b>Model Number:</b>	MRTA811LDC2	MRTA8FS10TDC2	MRTA810DC2
<b>Vacuum Pads:</b> <sup>1</sup> (8 each, standard rubber)	11" [28 cm] nomi. diameter, lipped (Model G3370)	10" [25 cm] nom. diameter (Model VPFS10T) <sup>2</sup>	10" [25 cm] nom. diameter, concave (Model G0750)
<b>Pad Spread:</b> <sup>3</sup>	----- (to outer edges) -----		
<b>Length</b> - <b>Maximum:</b>	104¾" [266 cm]	104" [264 cm]	102½" [260 cm]
- <b>Minimum:</b>	47" [119 cm]	46" [117 cm]	44¾" [114 cm]
<b>Width</b> - <b>Maximum:</b>	58¾" [149 cm]	58" [147 cm]	56½" [143 cm]
- <b>Minimum:</b>	12½" [32 cm]	11½" [29 cm]	10" [26 cm]
<b>Maximum Load Capacity:</b> <sup>4</sup>			
<b>Per-Pad:</b>	175 lbs [79.5 kg]	150 lbs [68 kg]	150 lbs [68 kg]
<b>With 4 Pads:</b>	700 lbs [320 kg]	600 lbs [270 kg]	600 lbs [270 kg]
<b>With 8 Pads:</b>	1400 lbs [635 kg]	1200 lbs [545 kg]	1200 lbs [545 kg]
<b>Lifter Weight:</b>	190 lbs [87 kg]		
<b>Power Source:</b>	12 volts DC, 4.5 amps		
<b>Battery Capacity:</b>	7 amp-hours		
<b>Rotation Capability:</b>	Manual, 360°, with latching at each ¼ revolution (when desired)		
<b>Tilt Capability:</b>	Manual, 90°, with four-bar tilt linkage that provides mechanical advantage and tilt locks that prevent tilt motion when engaged.		
<b>Options:</b>	Available with Model EO8RC - Remote Control System with 310-320 or 433-434 MHz radio signal, depending on requirements in your geographical location. See separate instructions about other options.		
<b>Operating Elevation:</b>	Maximum = 6000 feet [1828 meters]		
<b>Operating Temperatures:</b>	32° to 104° F [0° to 40° C]		
<b>Service Life:</b>	This lifter is designed to have a service life of at least 20,000 lifting cycles, when used and maintained as intended (vacuum pads, filter elements and other wear-out items are excluded).		
<b>ASME Standard BTH-1:</b>	Design Category "B", Service Class "0" (see www.wpg.com for more information)		

!!-CE-!! Note: This symbol appears in the *INSTRUCTIONS* manual only when requirements of a CE Standard are *different* from requirements of other standards that also apply to this vacuum lifter. CE requirements are mandatory in geographical areas where CE Standards apply, but may be optional in other locations.

- 1 Optionally available with alternative rubber compounds for special applications (see REPLACEMENT PARTS LIST).
- 2 Standard with replaceable sealing rings for rough or textured surfaces (see REPLACEMENT PARTS LIST).
- 3 The illustrations under ASSEMBLY: TO CHANGE THE PAD FRAME CONFIGURATION shows the Pad Spread and Maximum Load Capacity for many of the possible MRTA811LDC2 pad frame configurations.
- 4 The Maximum Load Capacity is rated at 16" Hg [-54 kPa] on clean, smooth, nonporous flat surfaces, with a friction coefficient of 1 (see MAINTENANCE: VACUUM PAD MAINTENANCE: Pad to Load Friction Coefficient). A qualified person should evaluate the effective lifting capacity for the actual application. In addition to the effect of friction between the vacuum pads and load, the lifting capacity may be affected by the following load characteristics: rigidity, strength, surface conditions, overhang, angle, center of gravity and temperature.



## SAFETY



The following safety rules must be observed to protect the operator and others from potential dangers.



Wear personal protective equipment that is appropriate for the material being handled. Follow trade association guidelines.



Operate the lifter under conditions approved for its design (see INTENDED USE: OPERATING ENVIRONMENT).



Do not operate a lifter that is damaged, malfunctioning, or missing parts.



Do not operate a lifter if the sealing edge of any vacuum pad is cut or otherwise damaged.



Do not remove or obscure safety labels.



Do not operate a lifter if the Maximum Load Capacity or any safety label appears to be missing or obscured.



Make certain the contact surfaces of the load and all vacuum pads are clean prior to applying the pads (see MAINTENANCE: VACUUM PAD MAINTENANCE).



Do not exceed the Maximum Load Capacity or attempt to lift loads the lifter is not designed for (see INTENDED USE: LOAD CHARACTERISTICS).



Do not attempt to lift cracked or broken glass with this lifter.



Position the vacuum pads correctly on the load prior to lifting (see OPERATION: TO APPLY THE PADS TO A LOAD).



Do not lift a load when any vacuum indicator shows inadequate vacuum.



Do not touch the vacuum release controls during a lift. This may result in loss of vacuum and release of the load.



Do not allow people to ride on the lifter or the load being lifted.



Do not lift a load higher than necessary or leave suspended loads unattended.



Do not lift a load over people.



Keep other personnel far enough away from the lifter to avoid injury in the event of an unexpected load release.



Place the power control in the inactive position and, when possible, disconnect the power source before opening any enclosure on the lifter. (Only applicable to powered lifters)



Do not make any modifications to the lifter (see LIMITED WARRANTY).

## OPERATING FEATURES

Note: Components shown here are underlined> on their first appearance in each section to follow.

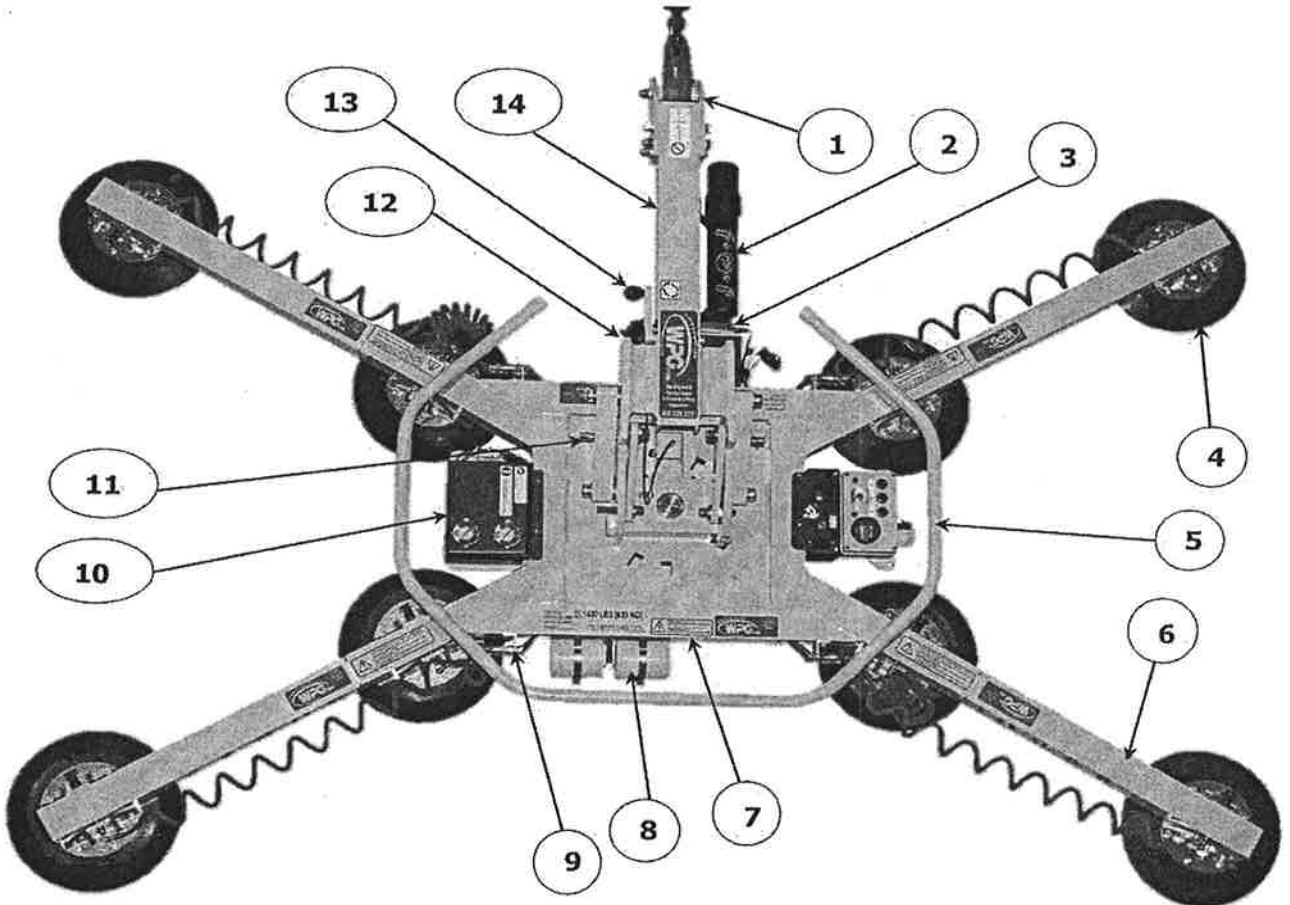

- |  |  |
|--|--|
| 1 LIFT SPOOL                           | 8 VACUUM RESERVE TANK                                |
| 2 INSTRUCTIONS CANISTER                | 9 QUICK CONNECTOR                                    |
| 3 BATTERY CHARGER                      | 10 Enclosure with VACUUM PUMP<br>and VACUUM SWITCHES |
| 4 VACUUM PAD with<br>MOVABLE PAD MOUNT | 11 TILT LOCK   |
| 5 CONTROL HANDLE                       | 12 BATTERY   |
| 6 EXTENSION ARM                        | 13 ROTATION RELEASE LEVER                            |
| 7 PAD FRAME                            | 14 LIFT BAR  |

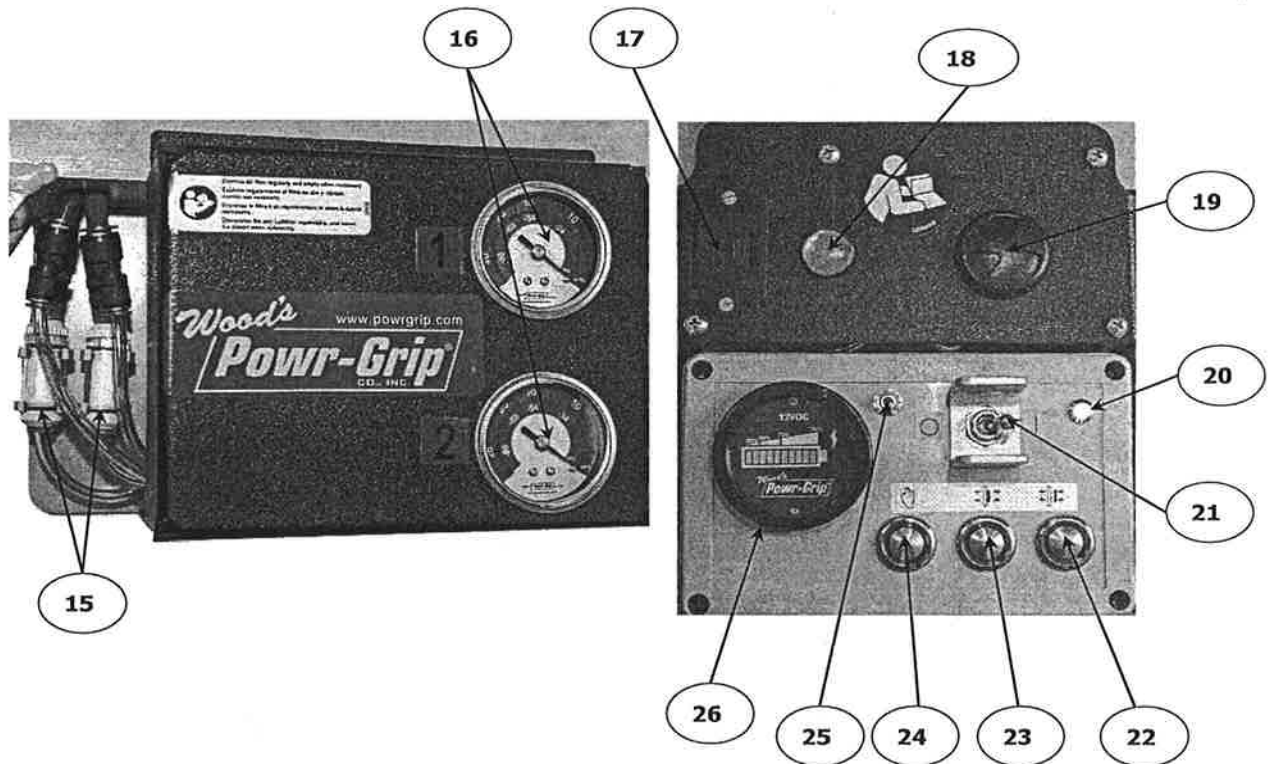

- 15 AIR FILTERS
- 16 VACUUM GAUGES
- 17 POWER LOSS WARNING BATTERY
- 18 VACUUM LIFT LIGHT
- 19 LOW VACUUM/POWER LOSS WARNING BUZZER
- 20 POWER INDICATOR LIGHT (BLUE)
- 21 POWER SWITCH
- 22 RELEASE BUTTON
- 23 APPLY BUTTON
- 24 ENABLE BUTTON
- 25 BATTERY TEST BUTTON
- 26 BATTERY GAUGE

## ASSEMBLY

- 1) Open the shipping container and remove all devices for restraining or protecting the vacuum lifter. Save the container and devices for use whenever the lifter is transported.
- 2) Suspend the lifter from a crane as follows: Select hoisting equipment (crane and hoist, when applicable) rated to carry the Maximum Load Capacity plus the Lifter Weight (see SPECIFICATIONS).

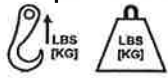

Note: Any application of the lifter must conform to all statutory or regulatory standards that relate to the hoisting equipment when used in its geographical location.

Disengage the tilt locks (see OPERATION: TO LIFT AND MOVE THE LOAD: Engaging or Disengaging Tilt Locks) and raise the lift bar as shown.

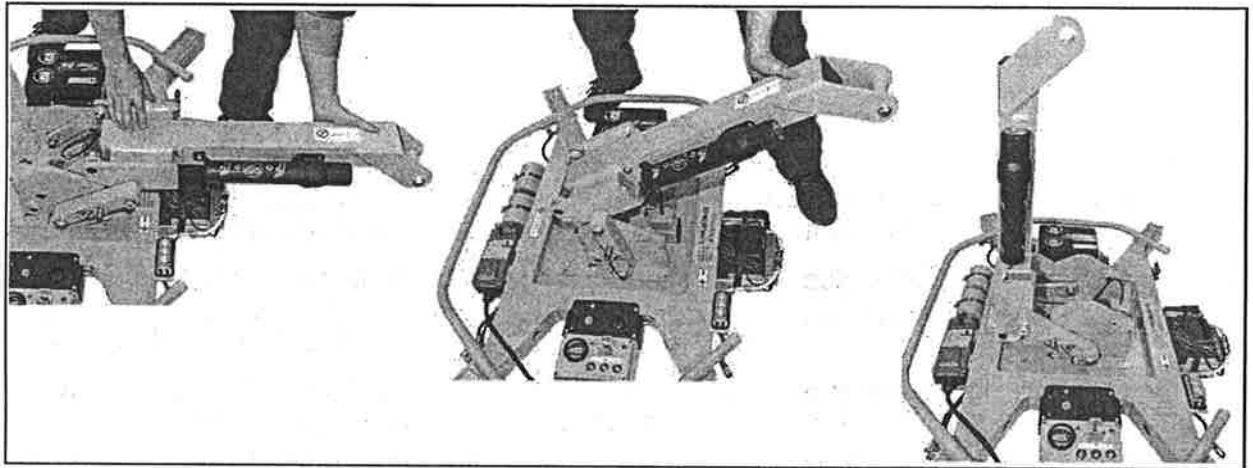



Then attach the hoisting equipment hook to the lift spool as shown.

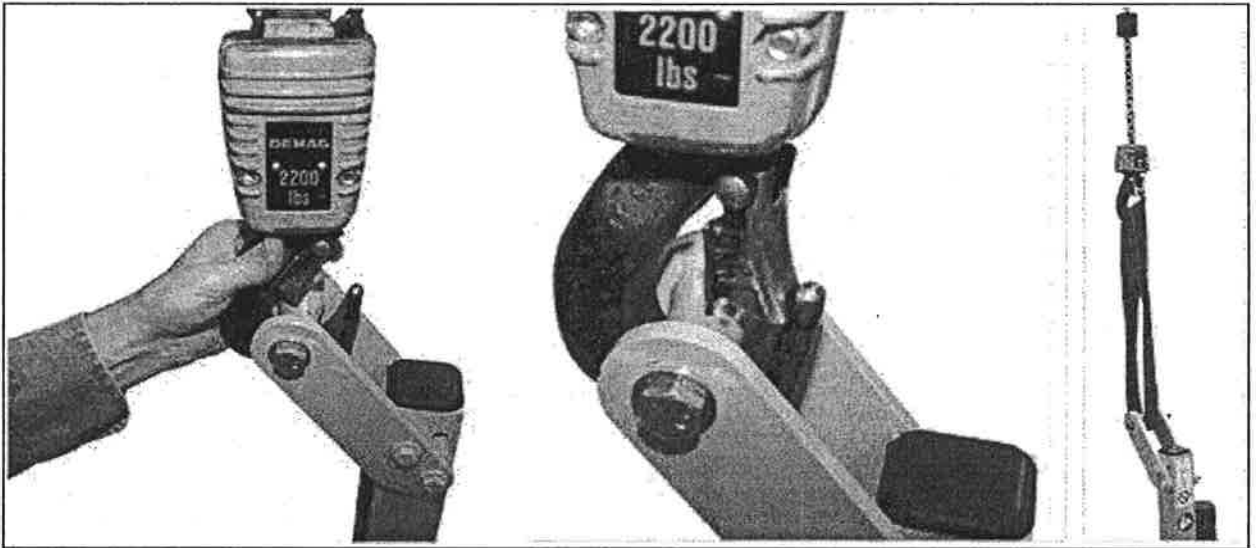

- ! **Make sure hoisting equipment hook is fitted with restraining latch to prevent lift spool from slipping off under any circumstances.**

Note: Make sure the hook does not interfere with the load, using a sling or other rigging as necessary.

- ! **Only use slings rated to carry Maximum Load Capacity plus Lifter Weight.**



Use the hoisting equipment to raise the lifter out of the shipping container. Be careful to avoid damaging any vacuum pads. Remove the pad covers as shown, and save them for use whenever the lifter is stored.



- 3) Configure the pad frame to provide optimal support of the load while lifting (see TO CHANGE THE PAD FRAME CONFIGURATION to follow).
- 4) Make sure the vacuum pads are clean (see MAINTENANCE: VACUUM PAD MAINTENANCE: Pad Cleaning).

5) Connect the electrical connectors as shown.

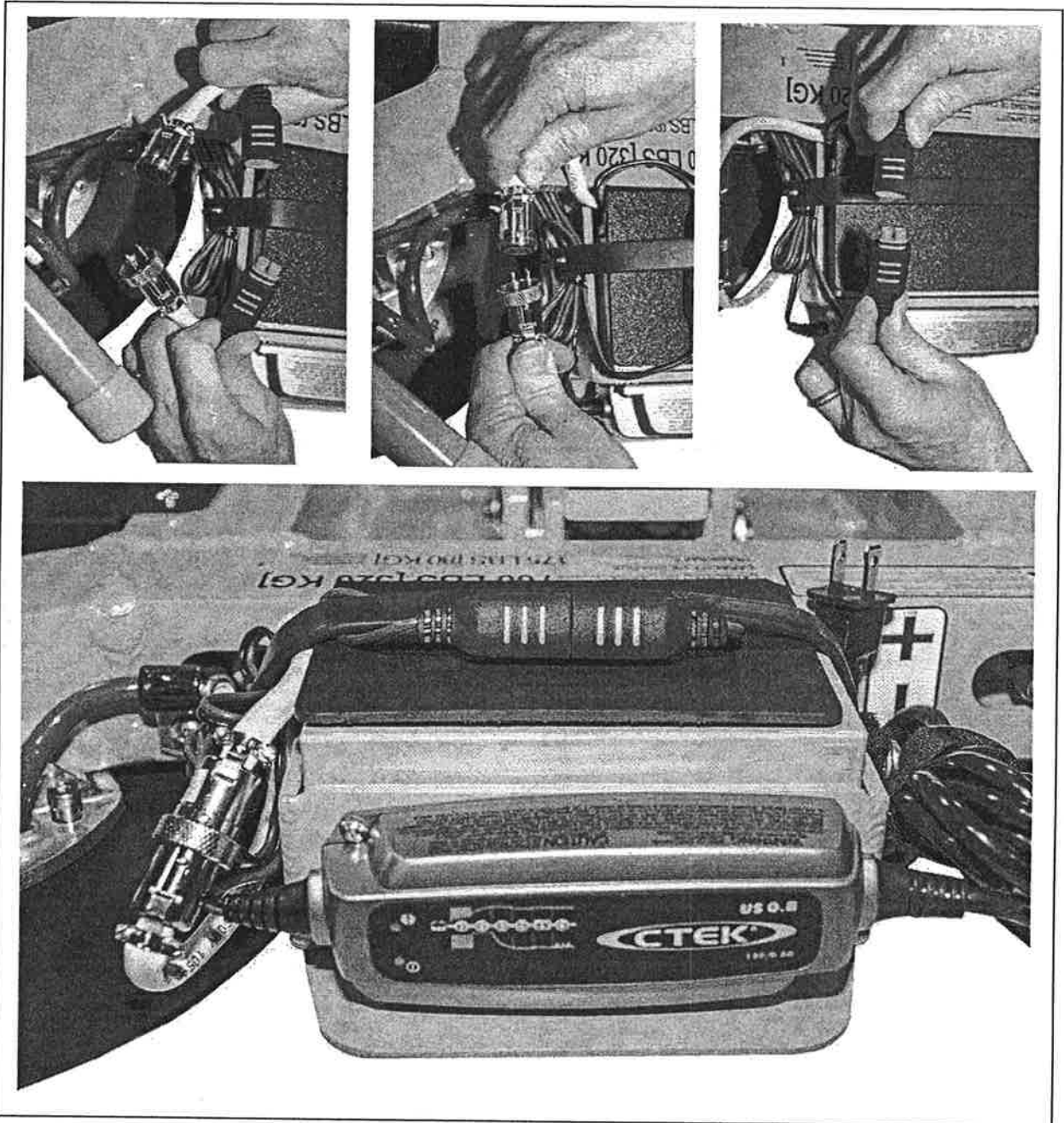

Install the power loss warning battery supplied as directed under MAINTENANCE: POWER LOSS WARNING BUZZER TEST.

6) Before you put the lifter into service, perform Operational and Load Tests (see MAINTENANCE: TESTING SCHEDULE).



## TO CHANGE THE PAD FRAME CONFIGURATION

A variety of pad frame configurations accommodate different load dimensions and weights, as shown. Configurations are created by installing or removing extension arms, by repositioning or removing movable pad mounts, and by connecting or disconnecting vacuum hoses to certain vacuum pads.

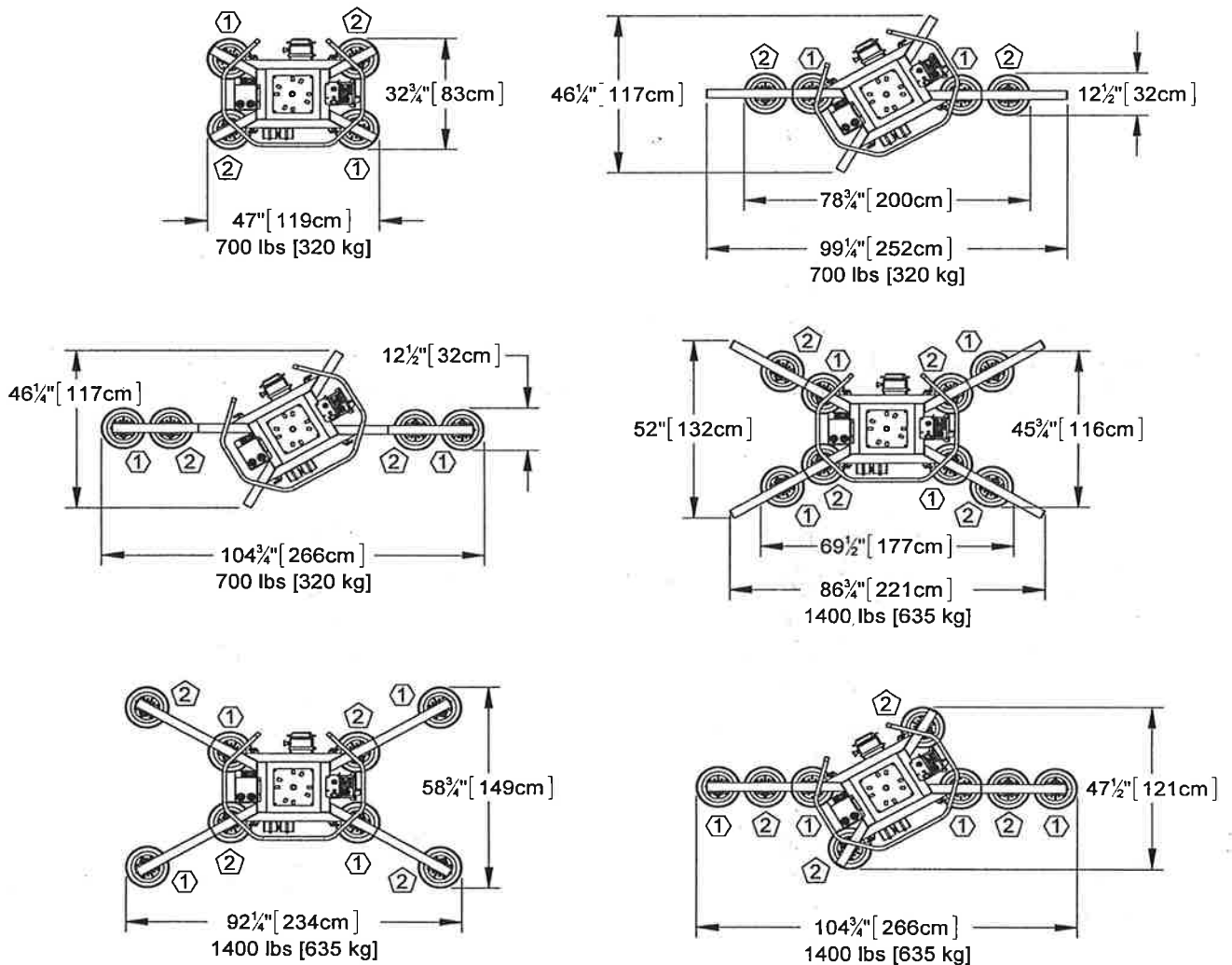

Standard MRTA811LDC2 pad frame shown.

(See SPECIFICATIONS for Pad Spread and Maximum Load Capacities of other models.)

Note: The dual vacuum system is equipped with 2 air-line circuits, which are identified by color-coded vacuum hoses. In order to ensure maximum effectiveness of the dual vacuum system, the vacuum pads must be connected in an equal and alternating distribution to the 2 circuits, as shown in the illustrations above. Vacuum pads marked "1" belong to the first circuit and vacuum pads marked "2" belong to the second circuit.



- 1) Select a configuration to provide optimal support across the load surface and to minimize load overhang (see INTENDED USE: LOAD CHARACTERISTICS).
  - To support the maximum load weight, you must install all vacuum pads on the pad frame (see TO INSTALL/REMOVE EXTENSION ARMS AND REPOSITION VACUUM PADS to follow) and connect all vacuum hoses to the vacuum pads, using the quick connectors (see discussion below).<sup>5</sup>
  - To support larger load dimensions, you must also install extension arms on the pad frame (see TO INSTALL/REMOVE EXTENSION ARMS AND REPOSITION VACUUM PADS to follow).
  - To support smaller weights and dimensions, you may remove some extension arms or vacuum pads, and disconnect the corresponding vacuum hoses, **provided that the lifter still has sufficient capacity to support the load in question.**



**Removing or disconnecting any vacuum pad reduces lifting capacity.**

- 2) Assemble the pad frame in a symmetrical configuration, to keep the lifter balanced (see illustrations on preceding page).



**Make sure all vacuum hoses are positioned to avoid damage during lifter operation.**

- 3) Make sure all vacuum hoses are secure and routed to avoid being pinched, snagged, abraded or otherwise damaged during lifter operation.

### To Connect/Disconnect Vacuum Hoses

To connect a vacuum hose, push the male and female ends of the quick connector together until they lock, as shown.

To disconnect the vacuum hose, move the release ring on the female end until the quick connector separates, as shown.



**Make sure that quick connectors seal completely and all vacuum hoses function correctly.**

Note: To ensure maximum effectiveness of the dual vacuum system, make sure that the vacuum pads are connected in an equal and alternating distribution to the 2 circuits of the vacuum system (see preceding illustrations).

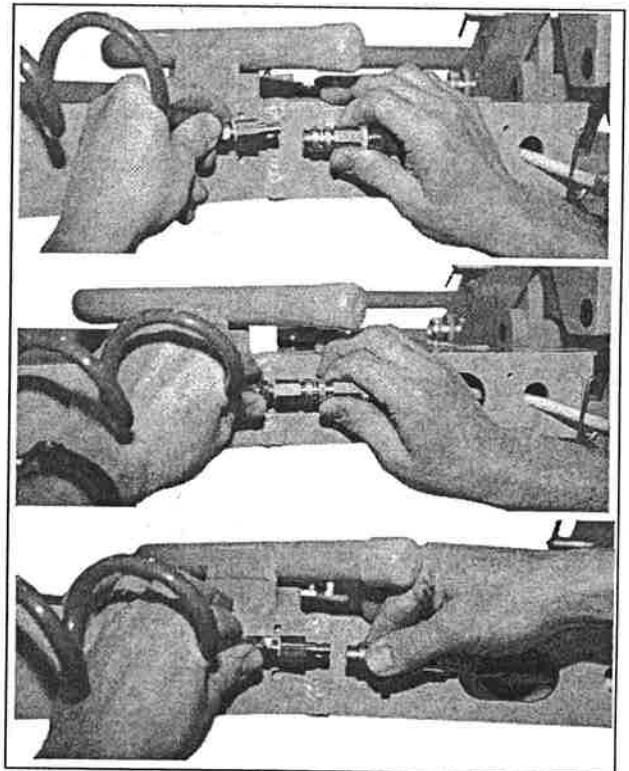

<sup>5</sup> Whenever a quick connector is disconnected, the corresponding vacuum pad does not contribute to the lifting capacity, whether or not the pad is mounted on the pad frame.

## To Install/Remove Extension Arms and Reposition Vacuum Pads

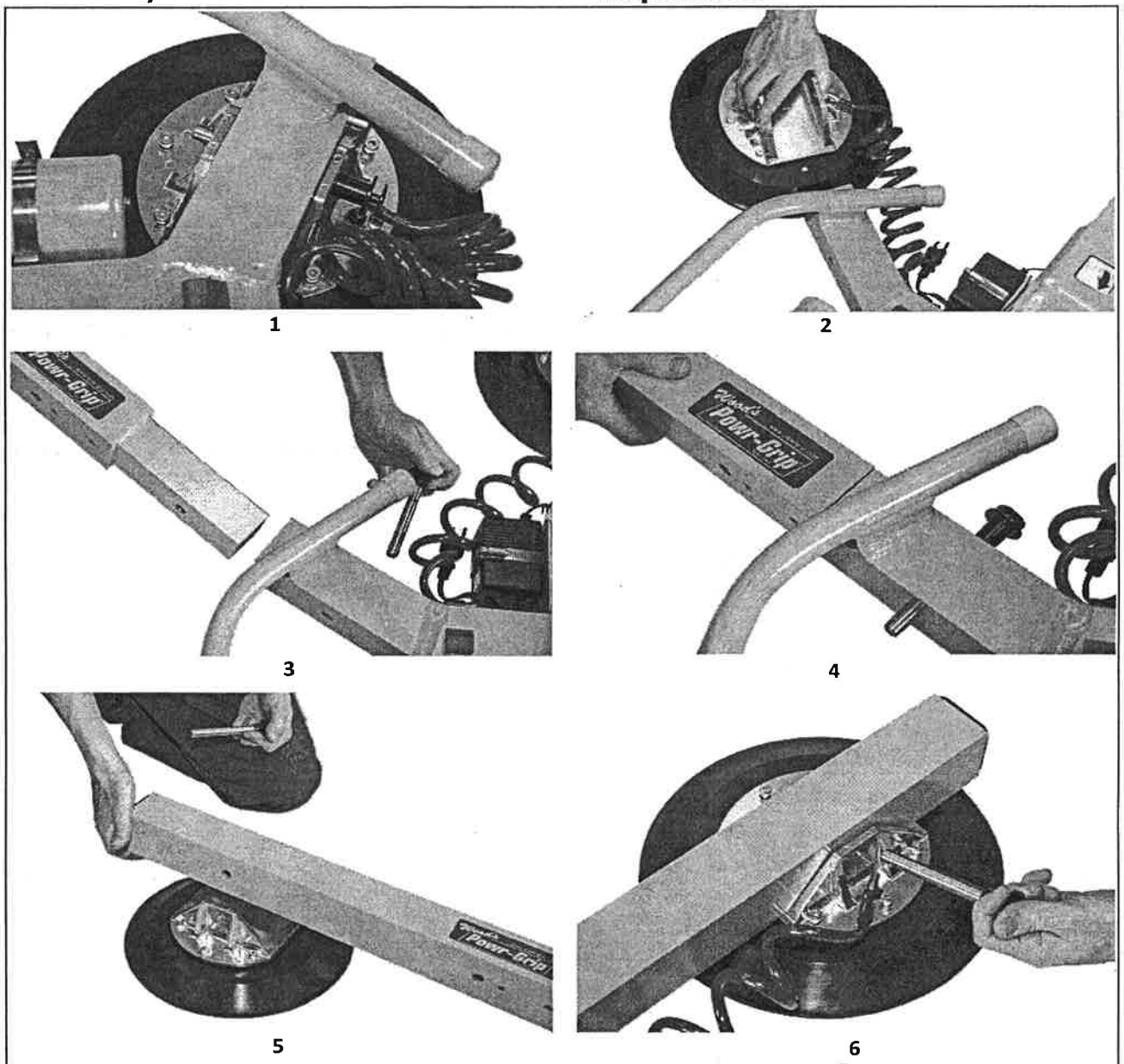

- 1) Remove the cotterless hitch pin that secures the movable pad mount to the pad frame.
- 2) Remove the vacuum pad from the pad frame and, if necessary, disconnect the vacuum hose.
- 3) Insert the extension arm into the pad frame.
- 4) Use a cotterless hitch pin to secure the extension arm.
- 5) Position the pad mount on the extension arm and, if necessary, reconnect the vacuum hose.
- 6) Use a cotterless hitch pin to secure the pad mount.

Note: Repeat or reverse these steps to configure the pad frame as needed.

To remove extension arms, reverse the previous procedure. To remove a vacuum pad, disconnect the corresponding vacuum hose and remove the movable pad mount as previously directed. Store removed components in a clean, dry location to protect them from environmental exposure.

### About Secondary Rotation Stops

Rotation stops are used to secure the load at each quarter turn, as desired. Secondary stops, located 30° from the primary stops, provide the same positioning when using a linear configuration of the pad frame (see preceding illustrations).

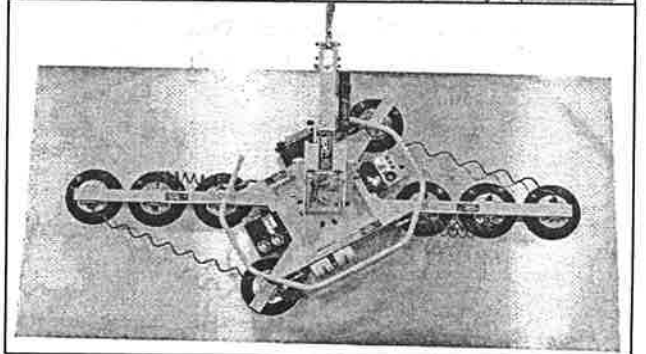
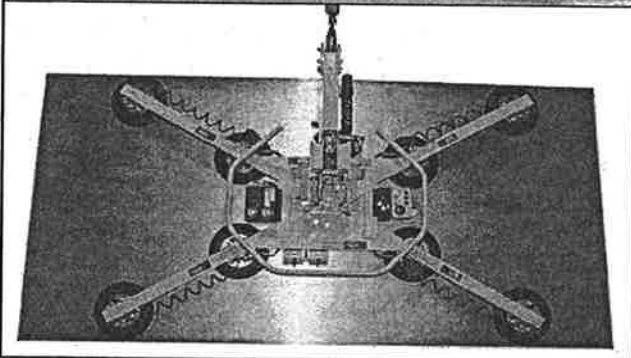
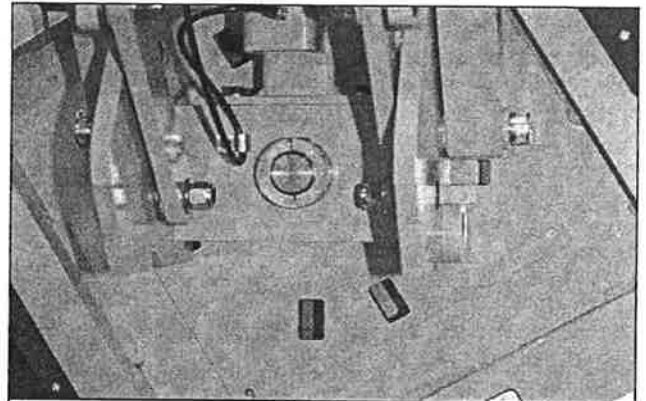
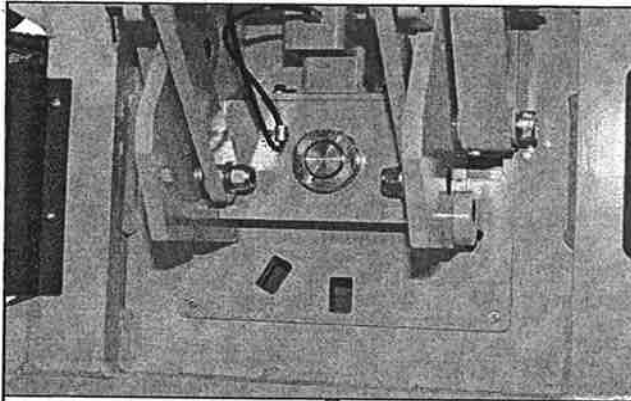





## INTENDED USE

### LOAD CHARACTERISTICS



***This lifter is NOT intended for lifting hazardous materials, such as explosives or radioactive substances.***

The operator must verify that the lifter is intended to handle each load, in accordance with the following requirements:

- The load weight must not exceed the Maximum Load Capacity (see SPECIFICATIONS). 
- The load must be a single piece of nonporous or semiporous material with a flat and relatively smooth contact surface.<sup>6</sup> To determine whether the load is too porous or rough, perform the test under Vacuum Level on Other Surfaces (see OPERATION: TO APPLY THE PADS TO A LOAD).
- The load's contact surface must be suitable for obtaining a friction coefficient of 1 with the lifter's vacuum pads (see MAINTENANCE: VACUUM PAD MAINTENANCE: Pad to Load Friction Coefficient).
- In order to avoid damaging the vacuum pads, the load's surface temperature must not exceed the Operating Temperatures (see SPECIFICATIONS).<sup>7</sup> 
- The load's *minimum* length and width are determined by the Pad Spread (see SPECIFICATIONS).
- The load's *maximum* length and width are determined by the allowable overhang, or the amount of load material that can extend sideways beyond the vacuum pads without breaking or otherwise being damaged.<sup>8</sup>
- 1½" [3.8 cm] is the maximum allowable thickness of loads at the Maximum Load Capacity (see SPECIFICATIONS).<sup>9</sup> 

Note: In order to maintain load stability in the upright position, the load must be positioned correctly on the lifter (see OPERATION: TO APPLY THE PADS TO A LOAD: Positioning the Lifter on the Load) and no other forces, such as wind pressure, can be at work on the load. Otherwise, the allowable load thickness would be reduced.<sup>10</sup>

<sup>6</sup> Lifters that feature concave vacuum pads can also attach to some kinds of curved loads. Since curvature affects the lifting capacity, contact Wood's Powr-Grip for help in determining the effective lifting capacity for a particular curved load.

<sup>7</sup> If such an application cannot be avoided, Wood's Powr-Grip does offer a heat-resistant rubber compound and other solutions which may enable you to lift loads with higher surface temperatures. Contact Wood's Powr-Grip or an authorized dealer for more information.

<sup>8</sup> The allowable overhang depends on the kind of load material being lifted, the thickness of the material, and the angle at which it is handled (if any). Since materials such as glass, stone or sheet metal each have different physical properties, the allowable overhang must be evaluated separately for each type of load. If necessary, contact Wood's Powr-Grip or an authorized dealer for help in determining the recommended overhang in a specific situation.

<sup>9</sup> This allowance does **not** account for the use of Pad Spacers (option CM3PE2). **Warning: Pad Spacers can reduce load stability in the upright position and, in some cases, the allowable thickness of loads.**



Note: Standard vacuum pads can stain or deform load surfaces with light colors or soft coatings. Test such surfaces for detrimental effects before using the lifter on them. Alternative rubber compounds are available for these applications; contact Wood's Powr-Grip or an authorized dealer for more information.

## OPERATING ENVIRONMENT

The operator must determine whether the lifter is intended to be used in each work environment, in accordance with the following restrictions:



***Never use lifter in dangerous environments.***

- This lifter is not intended for use in any environment that is inherently dangerous to the operator or likely to compromise the lifter's ability to function. Environments containing explosives, caustic chemicals and other dangerous substances must be avoided.
- The lifter's work environment is limited by the Operating Elevation and Operating Temperatures indicated in SPECIFICATIONS.
- The lifter's work environment must be free of metal particles or any other contaminants that could cause a vacuum pump failure. Such contaminants could result in a load release and possible injury to the operator or others nearby.

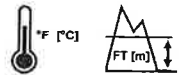

***Environmental contaminants could result in vacuum pump failure.***

- Using the lifter in wet environments may require the operator to take special precautions: Moisture on contact surfaces of the load or vacuum pads diminishes the lifter's slip resistance, thereby reducing the lifting capacity (see MAINTENANCE: VACUUM PAD MAINTENANCE: Pad to Load Friction Coefficient).



***Moisture reduces slip resistance of vacuum pads.***

The lifter is not designed to be water-tight. Submerging the lifter or using it in rain may damage lifter components; these and similar conditions must be avoided.

## DISPOSAL OF THE LIFTER

After the vacuum lifter has reached the end of its Service Life (see SPECIFICATIONS), dispose of it in compliance with all local codes and relevant regulatory standards.

Note: This lifter is equipped with a battery, which may be subject to special disposal regulations.

<sup>10</sup> However, allowable thickness normally increases as load weight decreases. If necessary, contact Wood's Powr-Grip for help in determining the maximum thickness permitted when handling any specific load.



## OPERATION

### BEFORE USING THE LIFTER

The operator must determine whether the lifter is capable of performing each intended task (see SPECIFICATIONS and INTENDED USE). In addition, all of the following preparations must be completed prior to lifting any load.

#### Taking Safety Precautions



**Read all directions and safety rules before using lifter.**

- Be trained in all relevant industry and regulatory standards required to operate the lifter in your location.



**Always wear appropriate personal protective equipment.**

- Take any personal precautions required to handle the load safely.
- Consult appropriate trade association guidelines to determine what precautions are necessary for each type of load material.

#### Performing Inspections and Tests



**Always check battery energy (as shown) before using lifter.** (See MAINTENANCE: BATTERY TEST)

- Perform all inspections and tests required by the INSPECTION and TESTING SCHEDULES (see MAINTENANCE).
- Always conduct a VACUUM TEST before placing a lifter in service (see MAINTENANCE).

**Caution: Examine each air filter regularly, and empty when necessary.**

Two air filters help protect the vacuum generating system from contaminants (see MAINTENANCE FEATURES) but would not necessarily prevent liquid from entering the vacuum system. Examine each filter regularly, to determine whether service is needed (see IN-LINE AIR FILTER SERVICE in SERVICE MANUAL for details).

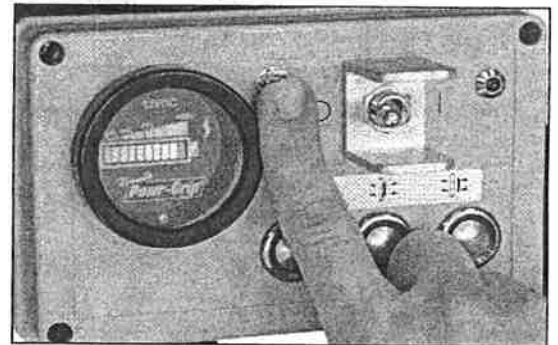

**!** *Make sure alarm is clearly audible over ambient noise at operator position.*

A low vacuum/power loss warning buzzer sounds an audible alarm in the case of these potentially dangerous situations. Rotate the shutter as shown to adjust the alarm volume. Make sure the alarm can be heard over ambient noise in the work area. The alarm must be clearly audible at the maximum distance between the operator and the lifter, despite any intervening barriers or obstructions.

In order to be considered clearly audible, ***the alarm volume must exceed ambient noise by at least 15 dBA at the operator position.***<sup>11</sup> Since the Maximum Alarm Volume is 103 dBA at 2 ft [60 cm], ambient noise must not exceed 88 dBA under any circumstances.<sup>12</sup>



<sup>11</sup> Consult CE Standard EN 457 for alternative ways to determine whether the alarm is clearly audible to operators.

<sup>12</sup> Furthermore, if ambient noise measures 88 dBA, the alarm volume must be set to maximum and the operator must remain within 2 ft [60 cm] of the warning buzzer, in order for it to be effective.



## Preparing to Use the Optional Remote Control System



The optional Remote Control System features a radio receiver, a radio transmitter and a strobe light, as shown.

If the lifter is equipped with this option, the operator can engage the lifter's apply and release functions at distances up to 250 ft [76 m], provided there is a direct and clear view of the lifter and its status indicators (see MAINTENANCE: REMOTE CONTROL SYSTEM TEST).

Whenever you are lifting a load from a remote location, follow these safety rules:

- Visually verify the status of the lifter and load prior to remote operations.
- Do not operate the lifter remotely unless there is clear communication about intended actions (eg, releasing load) with all personnel near the lift.



***Make sure nearby personnel are aware of intended remote control actions.***

- Monitor the lifter at all times to make sure that it is functioning as intended.<sup>13</sup>
- Be sure that the load is landed and supported correctly before releasing it (see TO RELEASE THE PADS FROM THE LOAD to follow).

Note: To prevent any radio transmission, press the emergency transmitter disconnect button on the radio transmitter. To reset the emergency disconnect, twist the button clockwise and allow it to spring outward to its normal position.

- 1 EMERGENCY TRANSMITTER DISCONNECT
- 2 TRANSMISSION INDICATOR LIGHT
- 3 RELEASE BUTTON
- 4 TRANSMITTER POWER/ENABLE BUTTON
- 5 APPLY BUTTON

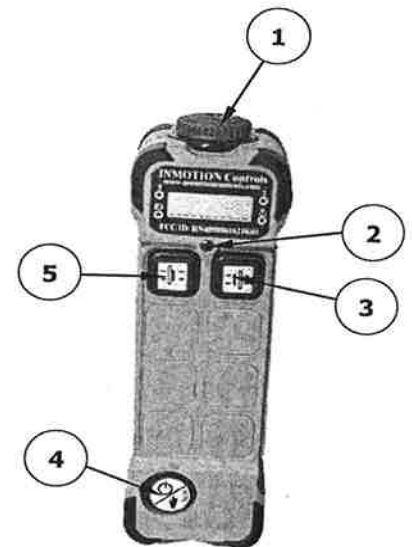

<sup>13</sup> The Remote Control System is designed with safeguards to prevent multiple lifters from responding until a clear transmission is received. Nevertheless, radio controlled lifters should be tested to ensure that each transmitter controls only one lifter. The buttons located on the lifter always function, regardless of any radio transmissions in the vicinity.



## TO APPLY THE PADS TO A LOAD

### Positioning the Lifter on the Load

- 1) Make sure that the contact surfaces of the load and all vacuum pads are clean (see MAINTENANCE: VACUUM PAD MAINTENANCE).

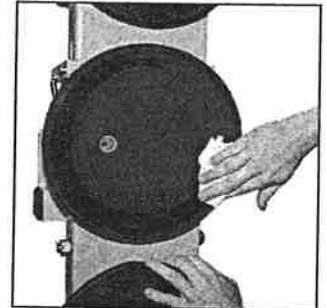

- 2) Center the lifter's pad frame on the load as shown, to avoid unexpected rotation or tilt (see TO LIFT AND MOVE THE LOAD: About the Tilt Linkage and TO ROTATE THE LOAD EDGEWISE to follow).<sup>14</sup>

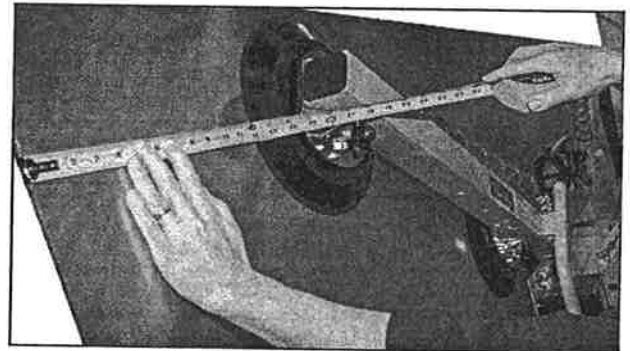
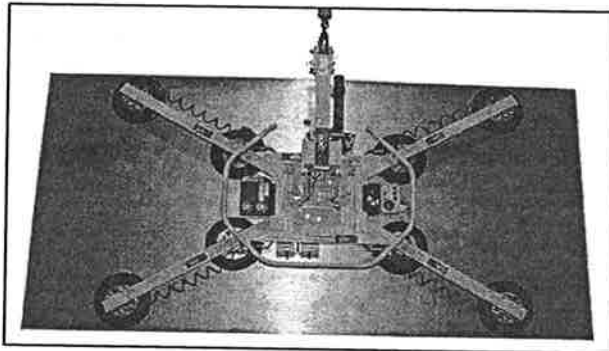

- 3) Make sure that all vacuum pads will fit on the load (see SPECIFICATIONS: Pad Spread) and that the pads will be loaded evenly (see SPECIFICATIONS: Per-Pad Load Capacity).
- 4) Apply the lifter to the load so that all vacuum pads are touching the contact surface.



<sup>14</sup> The lifter is designed to handle the maximum load weight (see SPECIFICATIONS: Maximum Load Capacity) when the load's center of gravity is positioned within 2" [5 cm] of the lifter's rotation axis. Occasional loading deviations are permissible, provided that the operator can maintain control of the load at all times and that the load weight is low enough to avoid damaging the lifter.





## Powering up the Lifter

Place the lifter's power switch in the ON (I) position, as shown (power indicator light turns on).<sup>15</sup>

 **Never turn power off while lifting.**

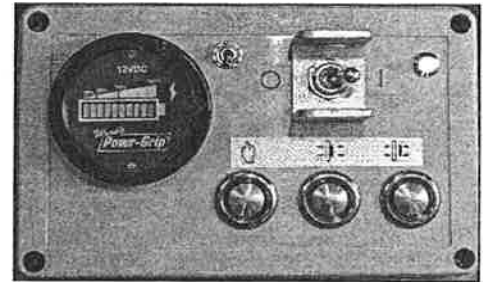
Keep the power switch in the ON position while lifting a load. Any power interruption could result in a load release and possible injury to the operator or others (see TO LIFT AND MOVE THE LOAD: In Case of Power Failure to follow).



 If the lifter is equipped with a Remote Control System, press the transmitter power (Φ) as shown and hold it briefly to activate the radio transmitter.<sup>16</sup>

Note: If the transmitter is activated, the transmission indicator light flashes green when any button on the transmitter is pressed and held; if the transmitter is not activated, the indicator light flashes red (see BEFORE USING THE LIFTER: Preparing to Use the Optional Remote Control preceding).



<sup>15</sup> When the operator powers up the lifter, either the stand-by function or the apply function is automatically activated, depending on which was used last.

<sup>16</sup> The radio transmitter turns off automatically, after a period of inactivity. The operator can also operate the lifter without using the radio transmitter, if desired.



## Sealing the Pads against the Load

Press the apply button (:||:) on the lifter as shown.



***Keep apply function activated throughout lift.***



If the lifter is equipped with a Remote Control System, press the apply button (:||:) on the radio transmitter as shown.



The vacuum pump will immediately begin to draw air through the vacuum pads, and the low vacuum warning buzzer will sound an alarm until the lifter attains sufficient vacuum to lift the maximum load weight (see TO LIFT AND MOVE THE LOAD: Interpreting the Warning Buzzer and Lift Light to follow). Firm pressure on the lifter helps the pads to seal against the load.<sup>17</sup>

<sup>17</sup> Although a vacuum pad may become distorted during shipping or storage, this condition should correct itself with continued use.



## Reading the Vacuum Gauges

Two vacuum gauges display the current vacuum level in positive inches of Hg and negative kPa for the 2 circuits of the lifter's vacuum system. A gauge's *green* range indicates vacuum levels sufficient for lifting the maximum load weight (see figure B1), whereas the *red* range indicates vacuum levels that are *not* sufficient for lifting the maximum load weight (see figure B2). If it takes more than 5 seconds for the vacuum level to reach 5" Hg [-17 kPa] on either vacuum gauge, press on any vacuum pad that has not yet sealed.

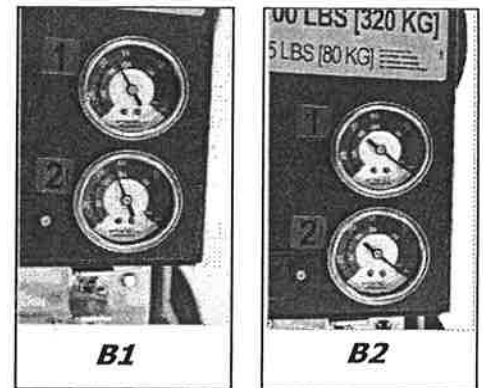

## Vacuum Level on Optimal Surfaces

When the lifter is attached to clean, smooth, nonporous load surfaces, it should be able to maintain a vacuum level in the green range on each vacuum gauge, except when used at high elevations (see SPECIFICATIONS: Operating Elevation). If not, make sure the corresponding vacuum switch is adjusted correctly (see DIGITAL VACUUM SWITCH ADJUSTMENT in  SERVICE MANUAL for details). If the vacuum switch cannot be adjusted to maintain a vacuum of 16" Hg [-54 kPa], perform the VACUUM TEST (see MAINTENANCE) to determine whether there is a deficiency in the vacuum generating system.

## Vacuum Level on Other Surfaces

When the lifter is attached to contaminated, rough or porous load surfaces, it may not be able to maintain a vacuum level in the green range on each vacuum gauge, due to leakage in the seal between the vacuum pads and the load surface.<sup>18</sup> In the case of contamination, thoroughly clean the contact surfaces of the load and the vacuum pads (see MAINTENANCE: VACUUM PAD MAINTENANCE: Pad Cleaning), and reapply the lifter to the load. If the load has rough or porous surfaces, **the operator must conduct a load suitability test**, as follows:

- 1) Make sure the lifter's vacuum generating system is functioning correctly (see MAINTENANCE: VACUUM TEST).
- 2) Apply the vacuum pads to the load as previously directed.
- 3) After the vacuum pump stops running, place the lifter's power switch in the OFF (☐) position.
- 4) Raise the load a minimal distance, to assure that it is supported by the lifter.
- 5) Monitor each vacuum gauge while the load is suspended for 5 minutes: **The lifter must maintain a minimum vacuum level of 10" Hg [-34 kPa] during this time.** If not, the load does not possess the characteristics required for using this lifter.<sup>19</sup>

<sup>18</sup> Contaminated loads can also cause the vacuum pump to run frequently or continuously. Since excessive pumping quickly reduces battery energy, the operator should clean the load when possible, to minimize pumping.

<sup>19</sup> Certain load materials are too rough or porous to allow the lifter to form a seal which can be maintained for 5 minutes without power. However, in geographical locations where CE Standards do not apply, it may be possible to use the lifter to lift such loads. Contact Wood's Powr-Grip for more information.



## TO LIFT AND MOVE THE LOAD



**Lift bar must be oriented vertically to lift load (see To TILT).**

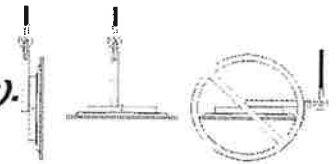

### About the Tilt Linkage

The tilt linkage is designed to minimize operator effort and to automatically hold a balanced load in either the upright or the flat position.



**Unbalanced loads may tilt unexpectedly during lifter operation.**

However, an unbalanced load may tilt unexpectedly when lifted, resulting in load damage or injury to anyone in the load's path.



**Make sure load is positioned correctly on lifter (see To APPLY).**

To minimize these risks, make certain **prior to lifting any load** that it has appropriate LOAD CHARACTERISTICS (see INTENDED USE) and is attached correctly to the lifter (see TO APPLY THE PADS TO A LOAD preceding).

### Engaging or Disengaging Tilt Locks

Although the tilt linkage normally holds a balanced load in position, the tilt locks can be used to prevent tilt motion due to wind loads or other unexpected forces. Tilt locks should only be needed if the operator cannot maintain control of the load using the control handle or other appropriate means (such as when using the lifter to install glass in multi-story buildings). Tilt locks are a secondary safety device and do not eliminate the need to load the lifter correctly (see TO APPLY THE PADS TO A LOAD: Positioning the Lifter on the Load preceding).

**Caution: Failure to load lifter correctly may damage tilt locks or other lifter components.**

*To engage tilt locks:*

- 1) Make sure the pad frame is oriented in either the horizontal or the vertical position.
- 2) Turn both T-handles to the engaged position (see figure B3).
- 3) Make sure that the plungers of both tilt locks are fully inserted in the corresponding holes on the lifter.

*To disengage tilt locks:*

- 1) Pull both T-handles outward and turn them to the disengaged position (see figure B4).
- 2) Make sure that the plungers of both tilt locks are fully retracted from the holes before attempting to tilt the lifter.

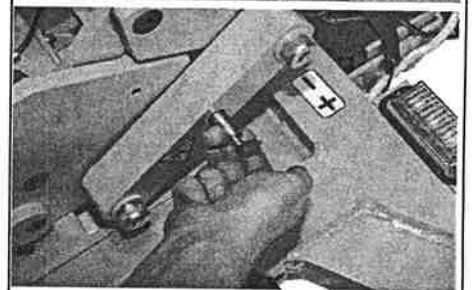
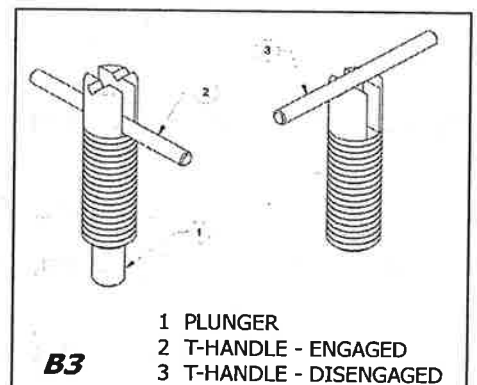



**B4**





## Interpreting the Warning Buzzer and Lift Light

 A lifter's Maximum Load Capacity is rated at a vacuum level of 16" Hg [-54 kPa] (see SPECIFICATIONS). After the lifter has attained this level, the low vacuum warning buzzer turns *off* and the green vacuum lift light turns *on* automatically, to signal that the lifter is ready to lift the maximum load weight. As vacuum continues to increase, the vacuum pump also turns off, to conserve battery energy.

-  **Never attempt to lift load while warning buzzer is sounding alarm.**
-  **Never attempt to lift load unless green lift light is illuminated.**

If you attempt to lift the load while the alarm is sounding or before the lift light is illuminated, this could result in a load release and possible injury.

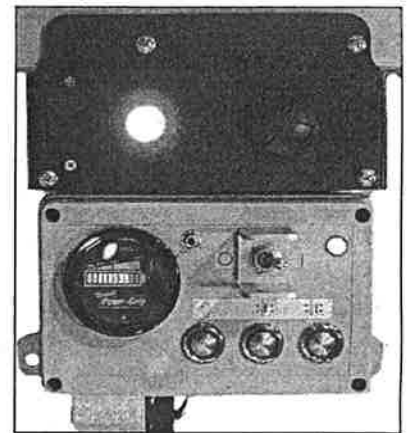

## Monitoring Vacuum Indicators

The vacuum lift light and both vacuum gauges must remain completely visible to the operator throughout the entire lift.

-  **Keep vacuum indicators visible throughout entire lift.**

If the vacuum system experiences leakage while the lifter is attached to the load, the vacuum pump turns on and off automatically, as required to maintain sufficient vacuum. Normally, such intermittent cycling of the pump is no cause for alarm.

However, if vacuum decreases significantly, the lift light turns *off* and the low vacuum warning buzzer turns *on*, to warn the operator. If this occurs while you are lifting a load, move away and stay clear of the load until it can be lowered to the ground or a stable support.



-  **Stay clear of any suspended load while indicators warn of low vacuum.**

Discontinue lifter use until the cause of the vacuum loss can be determined. If the pump runs at intervals of ten minutes or less while the lifter is attached to clean, smooth, nonporous materials, the leakage is likely to be in the vacuum system. In this event, perform the VACUUM TEST (see MAINTENANCE) and inspect the vacuum pads for damage (see MAINTENANCE: VACUUM PAD MAINTENANCE: Pad Inspection). If the vacuum loss cannot be remedied immediately, perform inspection and maintenance as needed to identify and correct any deficiency before resuming normal operation of the lifter.



## Controlling the Lifter and Load

When the vacuum indicators show that the lifter is ready, use the hoisting equipment to raise the lifter and load as needed to clear any obstacles in their path. Use the control handle to keep the lifter and load in the desired orientation while they are suspended from the crane, as shown. Once sufficient clearance is established, the load can be rotated or tilted as desired (see TO ROTATE THE LOAD EDGEWISE or TO TILT THE LOAD to follow).

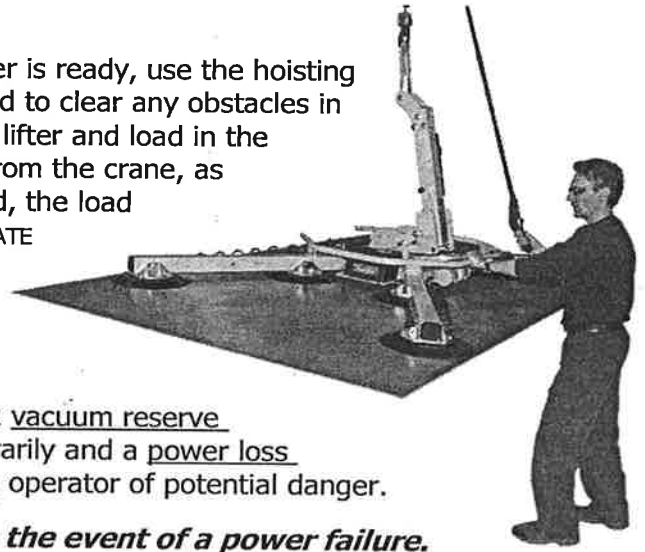

## In Case of Power Failure

In the case of a power failure (ie, in battery), 2 vacuum reserve tanks are designed to maintain vacuum temporarily and a power loss warning buzzer will sound an alarm to alert the operator of potential danger.



***Stay clear of any suspended load in the event of a power failure.***

Although the lifter is designed to support the load for at least 5 minutes without power, this depends on many factors (see INTENDED USE: LOAD CHARACTERISTICS and MAINTENANCE: VACUUM PAD MAINTENANCE, VACUUM TEST). If a power failure occurs, keep all personnel clear of the suspended load until it can safely be placed on the ground or a stable support. Correct any deficiency before resuming normal operation of the lifter.

## TO ROTATE THE LOAD EDGEWISE

**!** *Make sure load is positioned correctly on lifter (see To APPLY).*

- 1) Make sure there is sufficient clearance for the load to rotate without contacting the operator or any nearby objects.
- 2) Maintain a firm grip on the control handle to keep the load under control at all times (see figure B5).

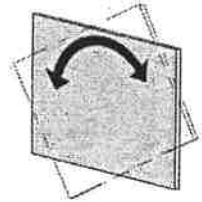

**!** *Unbalanced loads may rotate unexpectedly when latch is disengaged.*

- 3) Pull the rotation release lever to disengage the rotation latch, and rotate the load to the desired position as shown.

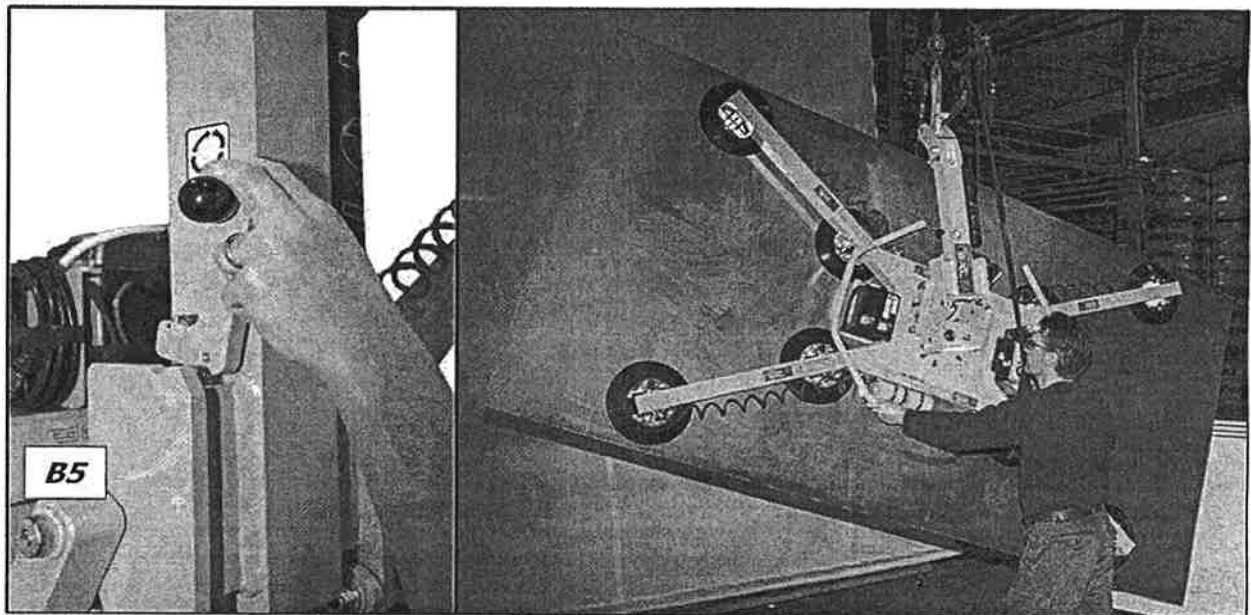

- 4) To stop the load's motion at each quarter turn, simply let go of the rotation release lever so that the rotation latch engages at the next appropriate stop (see ASSEMBLY: TO CHANGE THE PAD FRAME CONFIGURATION: About Secondary Rotation Stops).

Note: Whenever rotation is not required, keep the rotation latch engaged, to prevent accidental damage to the load and possible injury to the operator.

## TO TILT THE LOAD

**!** Always keep hands and fingers away from bars of tilt linkage.

- 1) Make sure there is sufficient clearance for the load to tilt without contacting the operator or any nearby objects.
- 2) Maintain a firm grip on the control handle to keep the load under control at all times, as shown below.
- 3) Make sure the tilt locks are disengaged (see TO LIFT AND MOVE THE LOAD: Engaging or Disengaging Tilt Locks preceding), and lift upward or press downward on the control handle to tilt the load as desired (see figure B6).

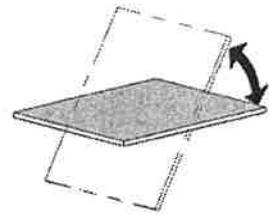

Note: Since the tilt linkage is designed to automatically maintain the load in either the upright or the flat position, the load force on the control handle changes direction during the tilt.

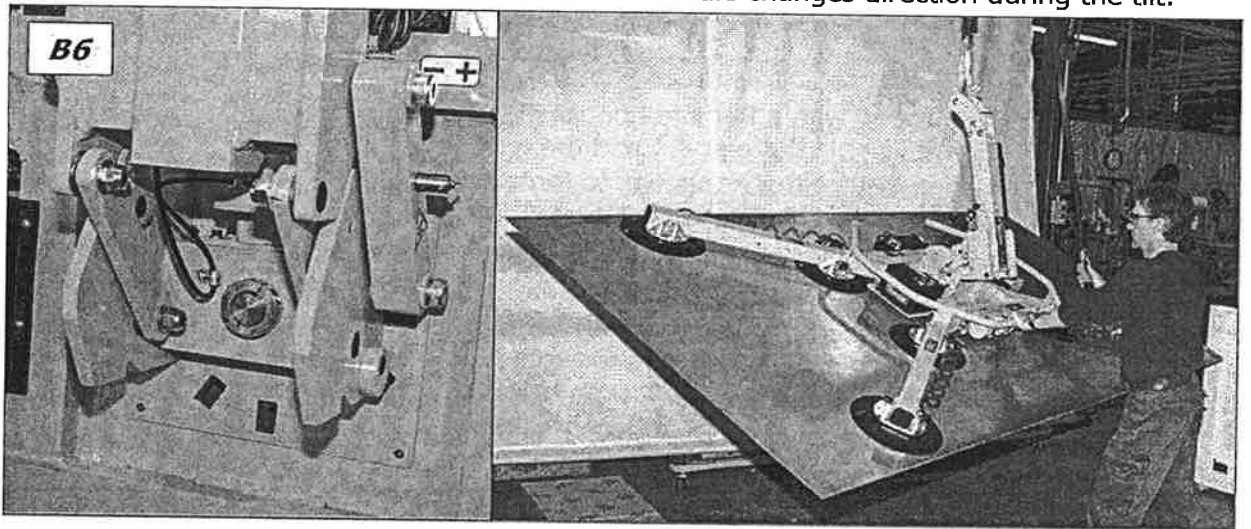

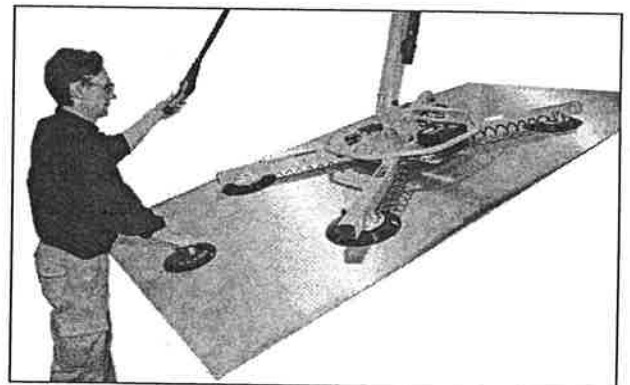

- 4) If load size permits, maintain control with the control handle throughout the tilt. For loads with overhang, it may be necessary to release the handle as the load approaches the flat position. If so, keep the load under control using hand cups or other appropriate means, as shown.







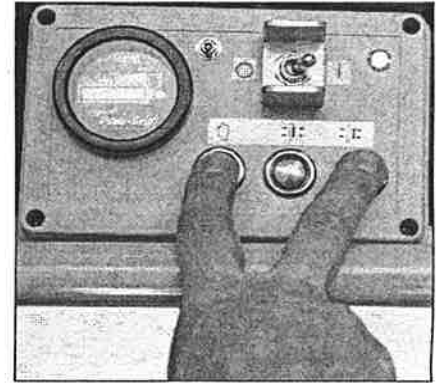

## TO RELEASE THE PADS FROM THE LOAD

**!** *Make sure load is fully supported before releasing vacuum pads.*

- 1) Make sure the load is at rest and fully supported.
- 2) Press and hold the enable button (  ) and the release button (  ) as shown, to force air into the vacuum pads, quickly breaking the vacuum seal.



 If the lifter is equipped with a Remote Control System, press and hold the enable button (  ) and the release button (  ) on the radio transmitter as shown, to force air into the vacuum pads, quickly breaking the vacuum seal.<sup>20</sup>

Note: The strobe light flashes as long as the operator is pressing the enable or release buttons. This shows the operator when

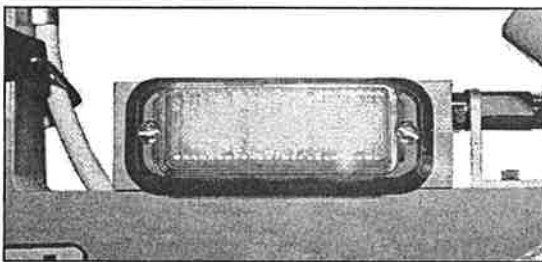

signals are being transmitted successfully from a remote location and also warns other personnel that the operator is preparing to release the load.



- 3) Continue to hold both the enable and release buttons until the vacuum pads disengage completely from the load.

**⊘** *Do not attempt to move lifter until vacuum pads disengage completely from load.*

Attempting to move the lifter before the vacuum pads are completely disengaged could result in load damage or injury.

After the load is successfully released, the lifter automatically activates the stand-by mode to conserve battery energy (only blue power indicator light remains illuminated).

- 4) Prior to lifting another load, perform the Every-Lift Inspection (see MAINTENANCE: INSPECTION SCHEDULE).

<sup>20</sup> The radio transmitter must be activated before the enable function can be used (see TO APPLY THE PADS TO A LOAD: Powering Up the Lifter).



## AFTER USING THE LIFTER

Place the power switch in the OFF (⊖) position, as shown (power indicator light turns off).

**Caution: Do not set lifter against any surfaces which could soil or damage vacuum pads.**

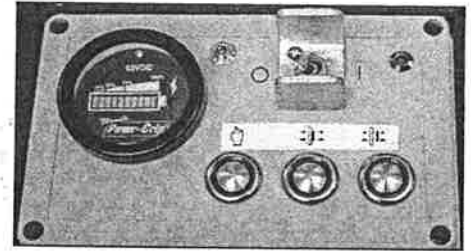

Use the hoisting equipment to gently lower the lifter onto a stable support; then detach the hoisting equipment hook from the lift spool.

If the lifter is transported to another location, use the original shipping container and secure the lifter so as to protect the vacuum pads and all other components from damage.



## Storing the Lifter

1) Use the covers supplied to keep the vacuum pads clean, as shown.

**!!-CE-!!** The lifter is designed to rest on relatively horizontal surfaces without tipping over. To store the lifter in this way, set the lifter with the pads facing downward on a clean, smooth, flat surface. Then lower the lift bar to a horizontal orientation and place a support under the lift spool.

2) Charge the battery completely when placing it in storage and at six-month intervals thereafter (see MAINTENANCE: BATTERY RECHARGE).

3) Disconnect the electrical connectors, as shown, in order to minimize battery drainage.

4) Store the battery at temperatures between 32° and 70° Fahrenheit [between 0° and 21° Celsius].

Note: Storage at temperatures above 100° Fahrenheit [38° Celsius] should be avoided.

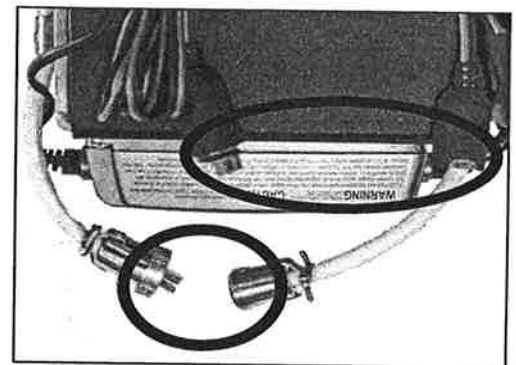

# MAINTENANCE FEATURES

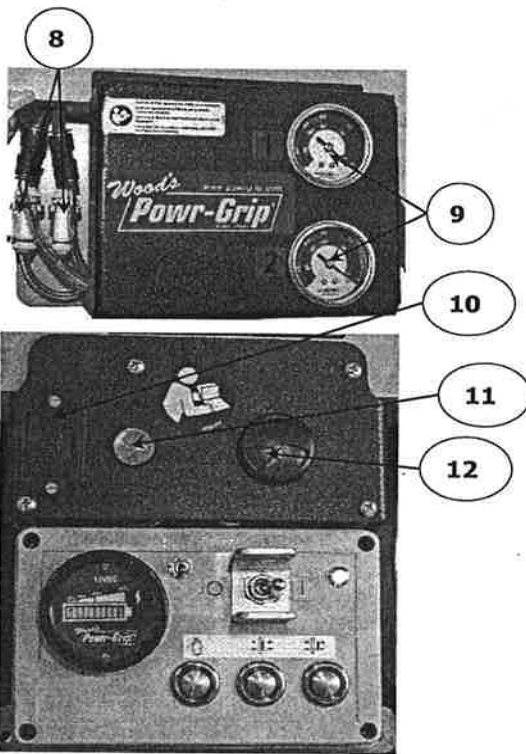
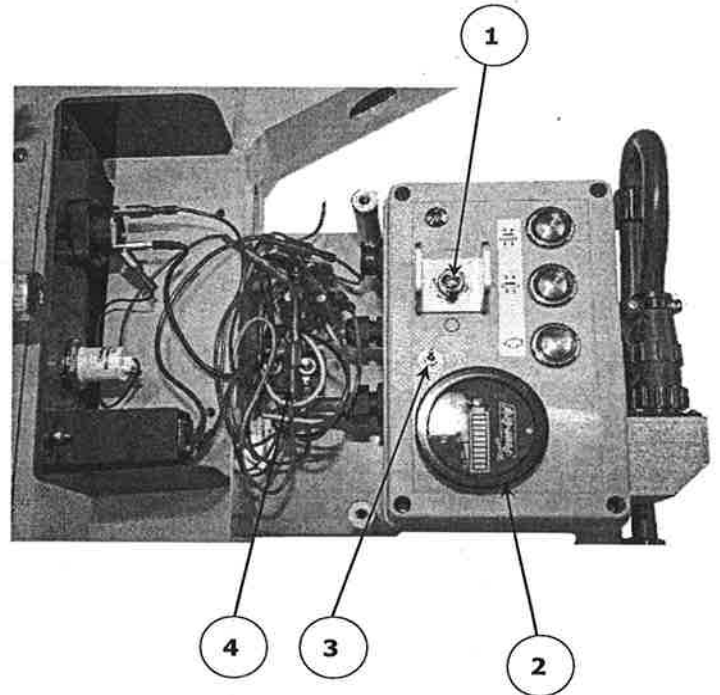
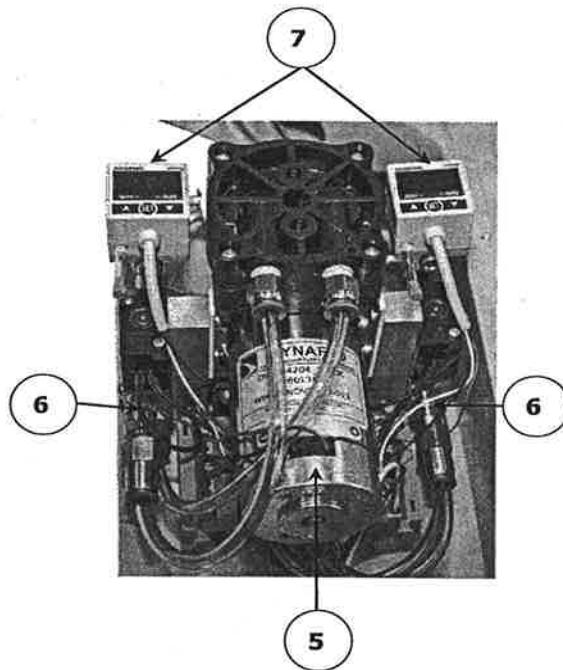

- 1 POWER SWITCH
- 2 BATTERY GAUGE
- 3 BATTERY TEST BUTTON
- 4 CIRCUIT BREAKER
- 5 VACUUM PUMP
- 6 CHECK VALVES
- 7 VACUUM SWITCHES
- 8 AIR FILTERS
- 9 VACUUM GAUGES
- 10 POWER LOSS WARNING BATTERY HOLDER
- 11 VACUUM LIFT LIGHT
- 12 LOW VACUUM/POWER LOSS WARNING BUZZER



# MAINTENANCE



**Make sure battery is disconnected before servicing lifter.**

Note: Refer to **SERVICE MANUAL #36100** when applicable.

## INSPECTION SCHEDULE

Perform inspections routinely, according to the following frequency schedule. If any deficiency is detected, correct it before using the lifter (see *SERVICE MANUAL* when necessary) and perform the next most frequent inspection.

Action	Every Lift	Frequent <sup>21</sup> (20-40 hours)	Periodic <sup>22</sup> (250-400 hours)
Examine the <u>vacuum pads</u> for contamination or debris, and clean them as necessary (see VACUUM PAD MAINTENANCE: Pad Cleaning).	✓	✓	✓
Examine the vacuum pads for visual damage.	✓	✓	✓
Examine the load surface for contamination or debris, and clean it as necessary.	✓	✓	✓
Examine the controls and indicators for visual damage.	✓	✓	✓
Test the <u>battery</u> for adequate charge. If necessary, charge and retest the battery (see BATTERY RECHARGE).	✓	✓	✓
Examine the lifter's structure for visual damage.		✓	✓
Examine the vacuum system (including <u>vacuum pads</u> , fittings and hoses) for visual damage.		✓	✓
Examine the <u>air filters</u> for conditions requiring service.		✓	✓
Perform the VACUUM TEST.		✓	✓
Check for unusual vibrations or noises while operating the lifter.		✓	✓
 If the lifter is equipped with a Remote Control System, perform the REMOTE CONTROL SYSTEM TEST.		✓	✓

<sup>21</sup> The Frequent Inspection is also required whenever the lifter is out of service for 1 month or more.

<sup>22</sup> The Periodic Inspection is also required whenever the lifter is out of service for 1 year or more. If necessary, return the lifter to Wood's Powr-Grip or an authorized dealer for repair (see LIMITED WARRANTY).





Action	Every Lift	Frequent	Periodic
Examine the entire lifter for external evidence of looseness, excessive wear, deformation, cracks, excessive corrosion, dents to structural or functional components, cuts, or any deficiency which might constitute a hazard.			✓
Inspect all parts of the electrical system for damage, wear or contamination that could constitute a hazard, in compliance with all local codes and regulatory standards that are relevant for the geographical region. <b>Caution: Be sure to use appropriate cleaning methods for each type of electrical component, as specified by codes and standards. Improper cleaning can damage components.</b>			✓
Keep a written record of all Periodic Inspections.			✓

Note: See following sections (VACUUM PAD MAINTENANCE, BATTERY TEST, VACUUM TEST) for details about these inspections.

### Infrequent Use

If a lifter is used less than 1 day in a 2-week period, perform the Periodic Inspection *each time before using the lifter*.

## TESTING SCHEDULE

Perform these tests when placing the lifter in service *initially* and *each time following a repair*. Correct any deficiency and retest before using the lifter.

Note: See following sections (BATTERY TEST, VACUUM TEST, etc) for details about these tests.

### Operational Tests

- Perform the VACUUM TEST to follow.
- Test all features and functions of the lifter (see OPERATING FEATURES, OPERATION and MAINTENANCE).

### Load Test

 Prove that the lifter can lift 100% of its Maximum Load Capacity (see SPECIFICATIONS), using an actual load or an equivalent simulation.<sup>23</sup> Employ the following method to test with an actual load:

- 1) Place a test load with appropriate LOAD CHARACTERISTICS (see INTENDED USE) on a stable support. Make sure the load is oriented in the upright position.<sup>24</sup>
- 2) Apply the vacuum pads to the load as previously directed.

<sup>23</sup> ASME Standard B30.20 requires the lifter to be tested to 125% of its Maximum Load Capacity.

<sup>24</sup> Flat Lifters are exempt from this requirement.



- 3) After the vacuum pump stops running, place the lifter's power switch in the OFF (⊖) position.
- 4) Raise the load a minimal distance, to assure that it is supported by the lifter.
- 5) Hold the load for 5 minutes. The load must not slip or fall during this time period. If it does, conduct a VACUUM TEST and inspect each vacuum pad as indicated under VACUUM PAD MAINTENANCE: Pad Inspection (see sections to follow). Correct any deficiency that is found and retest the lifter.

## BATTERY TEST

A battery gauge enables you to evaluate whether the battery has adequate energy for lifting. Check the battery energy before every lift and also at the end of each day's use, to decide whether a charge is needed (see BATTERY RECHARGE to follow).<sup>25</sup>

 **Never use lifter if battery energy is lower than 50% of capacity (only red lights illuminated).**

While the lifter's power switch is in the ON (⊏) position, the battery gauge automatically monitors battery energy (provided that the lifter is not in stand-by mode).<sup>26</sup>

While the lifter's power switch is in the OFF (⊖) position (or the lifter is in stand-by mode), the battery energy can be checked manually using the battery test button.<sup>27</sup>

Note: If the battery loses power, the power loss warning buzzer will sound an alarm (see POWER LOSS WARNING BUZZER TEST to follow).

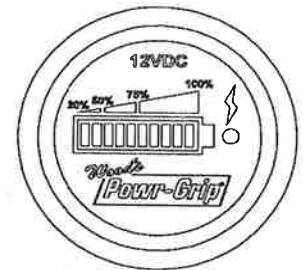

<sup>25</sup> The battery charger must be disconnected from its AC power source in order to test the battery energy; otherwise, the energy reading on the battery gauge would not be accurate.

<sup>26</sup> However, the battery gauge shuts off temporarily while the vacuum pump is running, to prevent an inaccurate reading. When the pumping cycle is completed, the battery gauge requires a few moments to stabilize before it displays an accurate energy reading again.

<sup>27</sup> If the lifter has not been used since the battery was charged, the battery gauge may falsely indicate an energy level that is higher than actual, due to a "surface charge" on the battery. After the pump runs for approximately one minute, the surface charge dissipates, allowing the operator to take an accurate energy reading.



## BATTERY RECHARGE

Charge the battery whenever the battery gauge indicates diminished energy (see BATTERY TEST preceding). **Caution: Make sure the lifter's power switch is in the OFF (⊖) position.**

Identify the input voltage marked on the battery charger, and plug it in to an appropriate power source.<sup>28</sup> Use a ground fault circuit interrupter to reduce the risk of electrical shocks.

**Make sure power source is equipped with ground fault circuit interrupter.**

The power lamp (Φ) turns on, to indicate that the charger is functioning. To determine charging status, consult the six-stage display on the charger. The battery is ready for use at stage 3 and fully charged at stage 5.

Normally, the battery should take no more than 8 hours to charge completely.<sup>29</sup> If not, check for the following conditions and correct any deficiencies as directed:

- Power lamp (Φ) flashes: Charger is not connected to battery; reconnect charger (see ASSEMBLY).
- Error lamp (!) turns on: Battery leads connected to the wrong poles; reverse battery leads.
- Error lamp (!) turns on and charging stops at stage 1 or stage 4: Battery is no longer functioning; replace battery (see REPLACEMENT PARTS LIST).

Be sure to unplug the charger and test the battery energy again before operating the lifter (see BATTERY TEST preceding).

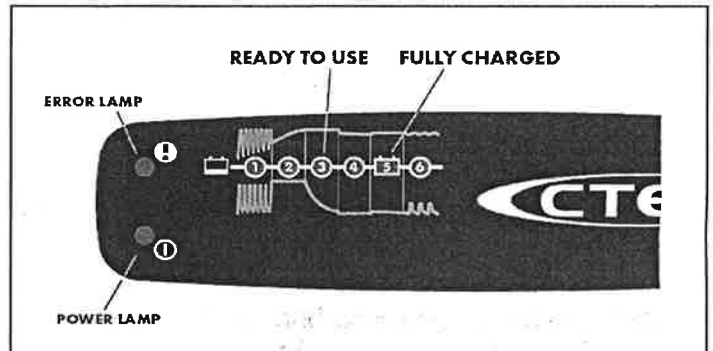

## POWER LOSS WARNING BUZZER TEST

The power loss warning buzzer is powered by an independent battery, which can be tested while the lifter is not running or attached to a load: Press the battery test button as shown and listen for the alarm. If the alarm does not sound, the battery must be replaced. Press the power loss warning battery holder inward, causing it to release, and slide the battery tray out as shown. Install a new 9-volt battery according to the polarity markings and retest the warning buzzer.

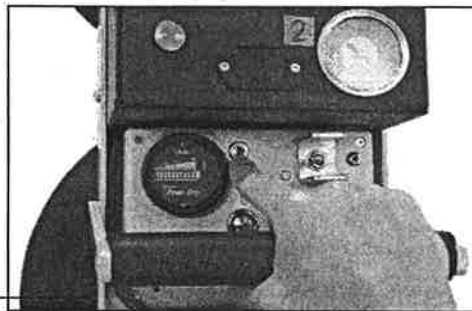

<sup>28</sup> Any external power supply must conform to all applicable local codes. **Caution: Do not operate the lifter while the charger is connected to an AC power source,** since this could result in permanent damage to the charger.

<sup>29</sup> The charger is designed to automatically sense the energy level of the battery and reduce the charging rate when the battery is fully charged. Accordingly, the charger does not need to be unplugged until the lifter is going to be used again.

## VACUUM PAD MAINTENANCE

### Pad to Load Friction Coefficient

 The friction coefficient represents the lifter's ability to resist load slippage (Note: Flat lifters are exempt). The Maximum Load Capacity assumes a friction coefficient of 1.0 (see SPECIFICATIONS). This rating is based on testing of clean, new, standard rubber vacuum pads on clean, dry, regular glass. If the lifter is used under other conditions, a qualified person must first determine the effective lifting capacity.

Exposure to heat, UV light or chemicals can cause vacuum pads to deteriorate. Standard rubber pads should be replaced on a regular basis (at least every 2 years), to prevent deterioration of the friction coefficient.

### Pad Inspection

Inspect each vacuum pad for the following deficiencies routinely (see preceding INSPECTION and TESTING SCHEDULES), and correct them before using the lifter.

- Contaminates on the pad face (1) or sealing edges (2) (see Pad Cleaning discussion to follow).
- Filter screen (3) missing from pad face (see REPLACEMENT PARTS LIST).
- Nicks, cuts or abrasions in sealing edges of vacuum pad (see REPLACEMENT PARTS LIST).<sup>30</sup>

 **Replace vacuum pad if sealing edge has any nicks, cuts or abrasions.**

- Wear, stiffness or glaze of vacuum pad (see REPLACEMENT PARTS LIST).

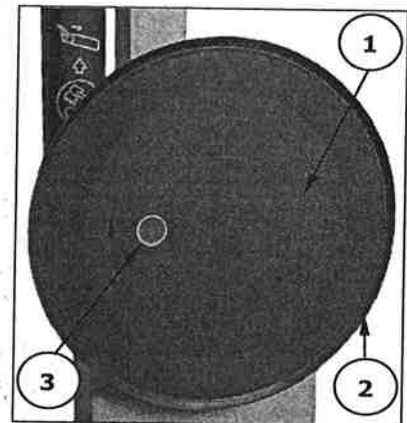

### Pad Cleaning

- 1) Regularly clean the face of each vacuum pad as shown, to remove oil, dust and any other contaminants. Acceptable cleaning agents include soapy water and other mild cleansers.

 **Never use solvents, gasoline or other harsh chemicals to clean vacuum pad.**

Solvents, petroleum-based products (including kerosene, gasoline and diesel fuel) or any harsh chemicals can damage vacuum pads.

 **Never use unauthorized rubber conditioners on vacuum pad.**

Most rubber conditioners, such as ArmorAll®, can leave a hazardous film on vacuum pads, which could compromise lifting capacity and/or create a hazard to the operator or others.

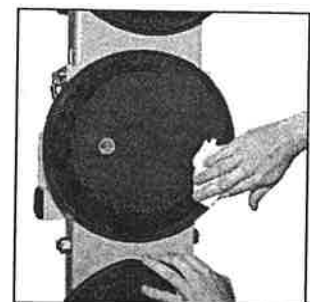

<sup>30</sup> If the lifter is equipped with VPFS10T or VPFS625 pads, the sealing edge is the replaceable sealing ring. When it is damaged, see TO REPLACE SEALING RING INSERT IN VACUUM PAD to follow.



- 2) Make sure to prevent liquid from contaminating the vacuum system through the suction hole on the pad face.
- 3) Use a clean sponge or lint-free cloth to apply an authorized cleanser and wipe the pad face clean.<sup>31</sup>
- 4) Allow the pad to dry completely before using the lifter.

## VACUUM TEST

Test the vacuum system for leakage routinely (see preceding INSPECTION and TESTING SCHEDULES).

- 1) Clean the face of each vacuum pad (see VACUUM PAD MAINTENANCE: Pad Cleaning).
- 2) Use a test load with a weight equal to the Maximum Load Capacity (see SPECIFICATIONS) and a clean, smooth, nonporous surface, as well as other appropriate LOAD CHARACTERISTICS (see INTENDED USE).<sup>32</sup>
- 3) Apply the lifter to the test load as previously directed (see OPERATION: TO APPLY THE PADS TO A LOAD). After the vacuum pump stops running, the vacuum level should register above 16" Hg [-54 kPa] on each of the vacuum gauges (if not, see DIGITAL VACUUM SWITCH ADJUSTMENT in *SERVICE MANUAL* for details).
- 4) Raise the load a minimal distance, to make sure that the vacuum pads are loaded to capacity, and place the lifter's power switch in the OFF (⓪) position.
- 5) Monitor the vacuum gauges: *The vacuum level should not decrease by more than 4" Hg [-14 kPa] in 5 minutes.*

 **Never use a lifter that has failed the VACUUM TEST.**

Correct any deficiency in the vacuum system before using the lifter.

<sup>31</sup> A toothbrush (or similar brush with bristles *that do not harm rubber*) may be used to remove contaminants clinging to sealing edges. If these cleaning methods are not successful, contact Wood's Powr-Grip or an authorized dealer for assistance.

<sup>32</sup> The load surface should be flat or possess no more curvature than the lifter is designed for (if any).



## REMOTE CONTROL SYSTEM TEST

 If the lifter is equipped with a Remote Control System, perform this test in the environment where the lifter is normally employed. Use the radio transmitter to activate each of the remote functions.<sup>33</sup> Vary the location and distance of the transmitter in relation to the lifter, to ensure that transmissions are effective in a variety of circumstances.<sup>34</sup>

If the Remote Control System does not function correctly, ...

- The battery for the radio transmitter may need to be replaced.
- Metal or other electrically conductive surfaces may be causing interference between the radio transmitter and radio receiver. Reposition the transmitter as necessary to transmit signals effectively.

If the problem persists, repeat the test under different conditions, to determine whether there is transmission interference in the work environment or the Remote Control System is not functioning as intended. Correct any deficiency before resuming normal use of the Remote Control System.

<sup>33</sup> Use a test material with appropriate surface characteristics (see INTENDED USE: LOAD CHARACTERISTICS) to test the apply and release functions.

<sup>34</sup> This may require assistance from someone near the lifter, to verify that functions are being performed as intended.

## TO REPLACE SEALING RING INSERT IN VACUUM PAD

If the lifter is equipped with VPFS10T vacuum pads, replace the sealing ring insert (see REPLACEMENT PARTS LIST) as shown:

- 1) Remove the old sealing ring insert.  
Make sure the entire vacuum pad is clean, including the mounting groove (see VACUUM PAD MAINTENANCE: Pad Cleaning preceding).
- 2) Place the inside edge of a new sealing ring insert against the inside edge of the mounting groove.
- 3) Push the sealing ring insert into the mounting groove, beginning in 4 locations as shown.
- 4) Push gently and firmly on the outside edge of the ring insert until its base (flat side) fits flush against the bottom of the mounting groove. A pad ring installation tool is available to facilitate this process (see REPLACEMENT PARTS LIST).
- 5) Make sure that the sealing ring seats completely and securely in the mounting groove, around the entire perimeter of the vacuum pad.

**Note:** If the ring insert ever comes partially or entirely out of the mounting groove, inspect the ring insert for damage and reinstall an undamaged ring insert according to preceding directions.

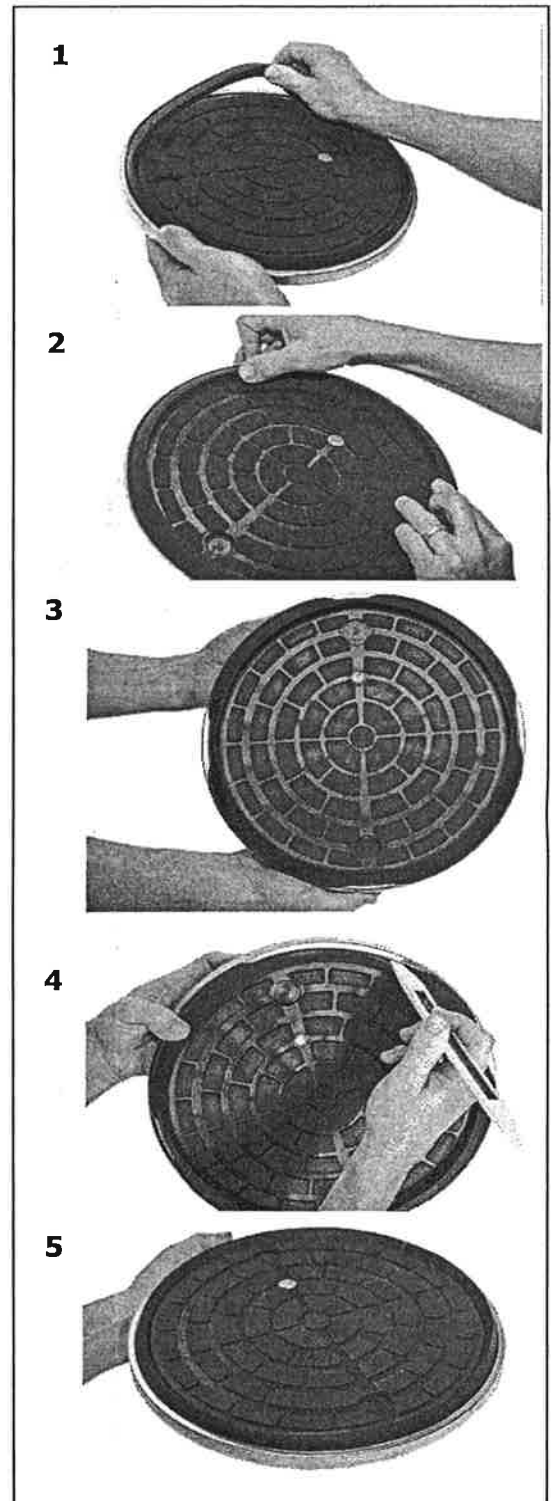



## REPLACEMENT PARTS LIST

Stock No.	Description	Qty.
65211	Check Valve - 1/8 NPT	2
64716	Battery Charger - 0.8 Amp - 240 V AC - Australian Type	1
64715	Battery Charger - 0.8 Amp - 240 V AC	1
64714	Battery Charger - 0.8 Amp - 100 / 120 V AC	1
64664	Battery - 12 V DC - 7 Amp-Hours	1
59086	Battery Connector - Twin Lead	1
49724TT	Sealing Ring Insert - Model VIFS10T2 - Closed Cell Foam (for VPFS10T pads)	8
49724LT	Sealing Ring Insert - Model VIFS10T1 - Low-Marking Rubber (for VPFS10T pads)	8
49646T	Vacuum Pad - Model G3370 / 11" [28 cm] Diameter - Lipped	8
49643T	Vacuum Pad - Model G3370 / 11" [28 cm] Diameter - Lipped - Low-Marking (option)	8
49672T	Vacuum Pad - Model VPFS10T / 10" [25 cm] Diameter - w/Replaceable Sealing Ring	8
49586TA	Vacuum Pad - Model G0750 / 10" [25 cm] Diameter - Concave (option)	8
36100	Service Manual - 12 V DC - 2.5 SCFM - Dual Vacuum System	1
29353	Pad Cover	8
20050	Pad Ring Installation Tool	1
16131	Element for Air Filter	2
15632	#60 Pad Filter Screen - Small (for G0750 & VPFS10T pads)	8
15630	#60 Pad Filter Screen - Large (for G3370 pads)	8

***SERVICE ONLY WITH IDENTICAL REPLACEMENT PARTS  
SUPPLIED BY OR APPROVED BY WOOD'S POWR-GRIP CO., INC.***





## LIMITED WARRANTY

Powr-Grip products are carefully constructed, thoroughly inspected at various stages of production, and individually tested. They are warranted to be free from defects in workmanship and materials for a period of one year from the date of purchase.

If a problem develops during the warranty period, follow the instructions hereafter to obtain warranty service. If inspection shows that the problem is due to defective workmanship or materials, Powr-Grip will repair the product without charge.

### **WARRANTY DOES NOT APPLY WHEN:**

- Modifications have been made to the product after leaving the factory.
- Rubber portions have been cut or scratched during use.
- Repairs are required due to abnormal wear and tear.
- The product has been damaged, misused, or neglected.

If a problem is not covered under warranty, Powr-Grip will notify the customer of costs prior to repair. If the customer agrees to pay all repair costs and to receive the repaired product on a C.O.D. basis, Powr-Grip then will proceed with repairs.

### **TO OBTAIN REPAIRS OR WARRANTY SERVICE**

For purchases in *North America*:

Contact the Technical Service Department at Wood's Powr-Grip Co. When factory service is required, ship the complete product—prepaid—along with your name, address and phone number to the street address hereafter.

For purchases in *all other localities*:

Contact your dealer or the Technical Service Department at Wood's Powr-Grip Co. for assistance.

Wood's Powr-Grip Co., Inc.  
908 West Main St. / P.O. Box 368  
Laurel, MT USA 59044

phone 800-548-7341

phone 406-628-8231

fax 406-628-8354





TYPE: <b>STANDARD</b>		DIRECTORY: <b>FILE SHEET:</b>	
WIRE LEGEND: CONTROLLED BY WIRING SYMBOLS DRAWING EXCEPT AS NOTED AND BELOW.		H:\Working\151040935-MRT\ECN 33633	
LINE STYLES AND WIDTHS FOR WIRE UNLESS NOTED OTHERWISE.		835L-W01 [L-W01]	
--- 24 AWG	--- 20 AWG	THIS DRAWING IS THE PROPERTY OF <b>WOOD'S POWR-GRIP CO., INC.</b> LAUREL, MONTANA U.S.A.	
--- 18 AWG	--- 15 AWG	700# MANUAL ROTATOR/FILTER	
PRODUCT MANAGER: <b>NATHAN G.</b>		DUAL VACUUM SYSTEM, RADIO READY	
DATE: <b>02/21/2014</b>	DATE: <b>02/26-14</b>	INDICATOR COVER WIRING SCHEMATIC	
CHECKED: <i>CP</i>	DATE: <b>02-26-14</b>	D835L-W01 [L-W01]	
APPROVED: <i>CP</i>	DATE: <b>2-27-14</b>	SIZE: <b>A</b>	SCALE: <b>NONE</b>
		REV: <b>0</b>	ECN NUMBER: <b>3363</b>
		DATE: <b>02/21/2014</b>	SY: <b>LER</b>
		EST. WEIGHT: <b>N/A</b>	

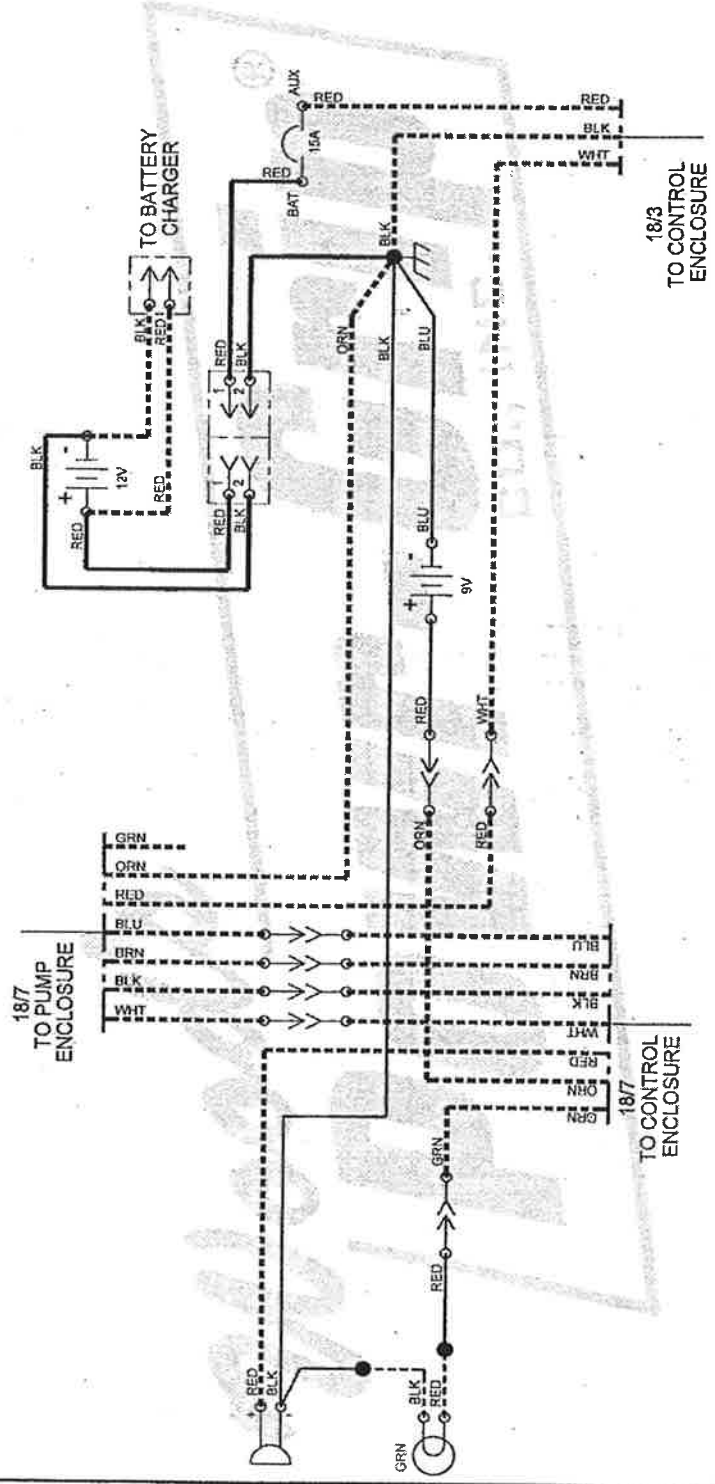



TYPE: <b>STANDARD</b> DIRECTORY: <b>FILE JSHEET:</b> THIS DRAWING IS THE PROPERTY OF <b>WOODS POWER-GRIP CO., INC.</b> IT IS LOANED WITH THE UNDERSTANDING THAT NEITHER IT NOR ANY INFORMATION CONTAINED THEREIN WILL BE COPIED, PUBLISHED OR TRANSMITTED TO OTHERS WITHOUT EXPRESS WRITTEN PERMISSION ALBANY, MONTANA U.S.A.		TBSR07 HAWKINGSTON8834-NRTECH 3363 <b>835L-W02 [L-W02]</b>	
WIRE LEGEND: CONTROLLED BY WIRING SYMBOLS DRAWING EXCEPT AS NOTED AND BELOW. LINE STYLES AND WIDTHS FOR WIRE UNLESS NOTED OTHERWISE. --- 24 AWG --- --- 18 AWG --- --- 20 AWG --- N/A		700# MANUAL ROTATOR/FILTER DUAL VACUUM SYSTEM, RADIO READY MAIN VACUUM SYSTEM WIRING SCHEMATIC D835L-W02 [L-W02]	
PRODUCT MANAGER: NATHAN G.	DATE: 02/21/2014	SCALE: NONE	REV.: 0
CHECKED: <i>CL</i>	DATE: 02-25-14	SIZE: A	ECN NUMBER: 3363
APPROVED: <i>CLM</i>	DATE: 2-26-14	BY: LER	EST WEIGHT: N/A

