

YANMAR®

MINI - EXCAVATORS

OPERATION & MAINTENANCE MANUAL (GB)

Models: **ViO17 (EP)**

ViO20-3

ViO25-3

ViO30/35-3

ViO50U

ViO57U







AMMANN - AMMANN YANMAR S.A.S. THANK YOU FOR PURCHASING AMMANN-YANMAR CONSTRUCTION MACHINERY

INTRODUCTION

- Read this manual carefully to learn how to operate and service your machine correctly.
- Failure to do so could result in personal injury or equipment damage.
- This manual should be considered a permanent part of your machine and should remain with the machine when you sell it.
- This machine is of metric design, and consequently the measurements in this manual are also metric.
- Use only metric hardware and tools as specified.
- Right and left-hand sides are determined by facing in the direction of forward travel.
- Warranty is provided as a part of AMMANN YANMAR's product support program for customers who operate and maintain their equipment as described in this manual. Should the equipment be abused, or modified to change its performance beyond the original factory specifications, the warranty will become void and field improvements under warranty may be denied. Setting fuel delivery above specifications or otherwise overpowering machines will result in such action.
- All information, illustrations and specifications in this manual are based on the latest product information available at the time of publication. Ammann-Yanmar reserves the right to modify the information and illustrations in this manual without notice. For additional information, contact your authorized Ammann-Yanmar distributor.
- The images in this book are provided as a rough guide and may vary according to the models.

CAUTION

- **Never attempt to operate or service this machine until you have first read and understood all of the applicable Safety instructions that are set forth in this Manual.**
- **The failure to comply with all relevant Safety instructions could result in bodily injury.**
- **To assure that this Manual will be conveniently available to future users, always return it to storage compartment, when it is not being used.**

REFERENCE INFORMATION

Write the correct information for your AMMANN YANMAR machine in the spaces below.
Always use these numbers when referring to your AMMANN YANMAR machine.

Model name	:	
Serial Number	:	
Engine Serial Number	:	
Your AMMANN YANMAR Machine Dealer	:	
Address	:	
Phone	:	



CERTIFICATE OF CONFORMITY EC

We undersigned attest that the following machine :

Hydraulic Miniexcavator AMMANN-YANMAR on crawlers

Type : **xxx**

Serialnumber : **xxx**

Special attachments : **xxx**

has been manufactured in conformity with 98/37/EEC, 89/514/EEC, 2005/88/EEC, 89/336/EEC, 2005/88/EEC and in accordance with national laws :

is according to the harmonized European Standard : EN 292-2 / EN 474-1 / EN 474-5

in conformity with the directive 2005/88/EC :

The technical documentation concerning the directive is kept on our production site at Saint-Dizier : **xxx**

Output of the engine : ... * ... tr/mn

Measured sound power level	... dBA
Guaranteed sound power level	... dBA

Place : Saint-Dizier

on xx/xx/xxxx

General Manager



CONTENTS

1. Introduction	3
2. Safety Information	4
3. Product Overview and regulation	6
3.1 Intended uses	6
3.2 Operation License	6
3.3 Lifting	6
4. Ordering Replacement Parts and Service Call	7
4.1 Location of machine serial number plate	7
4.2 Location of engine serial number plate	7
4.3 Location of the EPA identification plate	7
4.4 Ordering replacement parts and service calls	7

SAFETY

5. Basic Precautions	11
6. Operating Precautions	15
6.1 Precautions before starting the engine	15
6.2 Precautions when traveling	16
6.3 Precautions when working	18
6.4 Precautions for parking	20
6.5 Attachment precautions	21
6.6 Precautions for transportation	22
6.7 Precautions for the battery	23
7. Precautions for Servicing	25
7.1 Precautions before servicing	25
7.2 Replacing Essential Parts Periodically	25
7.3 Precautions during servicing	28
8. Safety Messages (Warning Labels)	31
8.1 Location of warning labels (depending on model)	32

OPERATION

9. Identification of Important Parts	37
9.1 Overview of the machine	37
9.2 Controls and switches (depending on model)	38
10. Description of operator's area	39
10.1 Monitor (depending on model)	39
10.2 Switch (depending on model)	41
10.3 Control levers and pedals	44
10.4 Storage space for the operation & maintenance manual (depending on model)	48
10.5 Operator's seat	49
10.6 Fuses	49
10.7 Windshield (for cabin)	51
10.8 Air outlet (for cabin)	53
10.9 Ash tray (for cabin)	54
10.10 Right window glass (for cabin)	54
10.11 Cabin side door	54
10.12 Replenishment of windshield washer fluid (for cabin)	55
11. Instructions	56
11.1 Break in period	56
11.2 Checking before starting the engine	56
11.3 Precautions for operating the implement	59
11.4 Handling the rubber crawler	61
11.5 Handling hydraulic P.T.O.	62



11.6	Operation of the air conditioning heater (depending on model)	63
11.7	Using the refuelling electrical pump (depending on model)	66
12.	Transportation	67
12.1	Precautions for transporting the machine	67
12.2	Machine tie-down	67
12.3	Machine slinging	68
13.	Long-term Storage	70
14.	Troubleshooting	71
14.1	Phenomena that are not breakdowns	71
14.2	Troubleshooting	72

MAINTENANCE

15.	Precautions for Servicing	77
16.	Basic Servicing Practices	78
16.1	Filter	78
17.	Fueling, Oiling and Greasing Based on Temperature Range	79
17.1	Fuel and oil	79
17.2	Cooling water	79
18.	Standard Tightening Torque for Bolts and Nuts	81
18.1	Torque table	81
19.	Maintenance Table	82
19.1	Service intervals when using the hydraulic breaker	82
19.2	List of periodic inspection and servicing	83
20.	Procedures for Maintenance	85
20.1	Checking and adjusting the rubber crawler tension	85
20.2	Checking and adjusting the fan belt tension	86
20.3	Greasing (depending on model)	87
20.4	Greasing the swing gear and the swing bearing	88
20.5	Changing the water separator element	88
20.6	Changing the fuel filter element	88
20.7	Checking and replenishing the lube oil for the travel reduction gearbox	89
20.8	Servicing the air conditioning heater (depending on model)	89

SPECIFICATIONS

21.	Specifications	93
21.1	Specifications	93
21.2	Model view and working range (Cabin / Canopy)	97
21.3	Noise emitted by the machines	100
21.4	Vibrations emitted by the machines	101
21.5	Lifting capacity	102
22.	Options	115
22.1	Options	115

HYDRAULIC AND WIRING DIAGRAMS

23.	Hydraulic and wiring diagrams	131
23.1	Hydraulic diagrams	131
23.2	Wiring diagrams	138

NOTES

24.	Maintenance	145
25.	Notes	149



1 Introduction

This Operation and Maintenance Manual for the AMMANN YANMAR machine is designed to provide you with important information and suggestions necessary for using the machine with safety and efficiency.

Please be sure to read through the manual before using the machine, to make yourself familiar with the procedures and instructions for operating, inspecting and servicing. Keep in mind that failure to observe the precautions given in the manual or using any procedures not prescribed in the manual may cause a serious accident.

WARNING

Improper use of the machine may lead to hazards which can result in death or serious injury. Personnel engaged in operating and maintaining the machine are required to familiarize themselves with the contents of the manual before setting about their job.

- **Do not attempt to operate the machine before making yourself familiar with the contents of the manual.**
- **Personnel responsible for using the machine must keep the manual at hand and review it periodically.**
- **If the manual should be lost or damaged, promptly order a new copy from the dealer.**
- **When you transfer the machine to another user, always transfer the manual as well.**
- **We at AMMANN YANMAR provide customers with products in compliance with all applicable your country's regulations and industrial standards. If you are using a AMMANN YANMAR machine purchased abroad, the machine may lack some safety devices. Please consult your dealer to confirm whether or not that machine is in compliance with all applicable your country's regulations and industrial standards.**
- **Some machine specifications may differ from those which are described in this manual because of improvements in its design and performance. If you have any questions about the contents of the manual, don't hesitate to contact your dealer.**
- **Important safety instructions have been presented throughout this manual, and have been summarized in PART : SAFETY. Be sure to review these pages and pay heed to those safety instructions before proceeding to operate the machine.**



2 Safety Information

The following Signal Words have been used in this Manual and on the Safety Signs to indicate the seriousness of the hazards that could be encountered by failing to comply with the applicable Product Warnings, as follows:

DANGER

Could result in death or catastrophic bodily injury.

WARNING

Could result in bodily injury.

CAUTION

Could result in property damage.

IMPORTANT

The signal Word "IMPORTANT" has been utilized in this Manual to denote those User Directions that must be followed to assure the safe operation and maintenance of the machine.

- **WARNING** : The operator of this machine must be competent and trained for its use.
- **WARNING** : Never attempt to operate or service this machine until you have first read and understood all of the applicable Product Warnings and User Directions that are set forth in this Manual and on the Safety Signs that are affixed to this machine.

The failure to comply with all relevant Safety Instructions could result in bodily injury.

- **WARNING** : Never modify the design of this machine or its engine; never remove or disable any of the installed safety guards or devices; and never use any unauthorized attachments in the operation of this equipment.

The implementation of any unauthorized design modifications or the use of unauthorized attachments could result in bodily injury.

Furthermore, since those actions would expressly violate the terms of AMMANN YANMAR's Product Warranty, the applicable Warranty would also be voided.



2 Safety Information

In this Manual, the major sections of the product are designated as follows:

Machine (1).....refers to the entire product.

Implement (2).....refers to the section consisting of the arm, boom and bucket or other attachment.

Machine base (3).....refers to the section consisting of the upperstructure and the undercarriage.

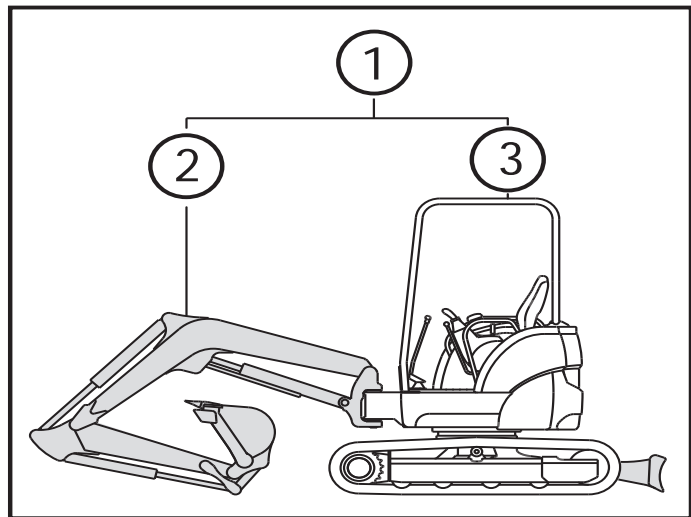



3 Product Overview and regulation

3.1 Intended uses

The machine is intended to perform the following tasks:

- Digging
- Shoveling
- Ditching

3.2 Operation License

Before you operate this machine, confirm the licensing requirements that are applicable to the operation of this machine. Comply with all applicable laws.

Ask your dealer about licensing requirements.

3.3 Lifting

The use of the machine as lifting equipment is subject to the machine Directive 98/37/CE and to the specific legislation of each country.

In case of use not complying with the instructions in this standard, the AMMANN YANMAR company declines any responsibility.

WARNING

It is prohibited to transport or hoist persons with this machine.

WARNING

Refer to your AMMANN-YANMAR dealer for more information.

4 Ordering Replacement Parts and Service Call

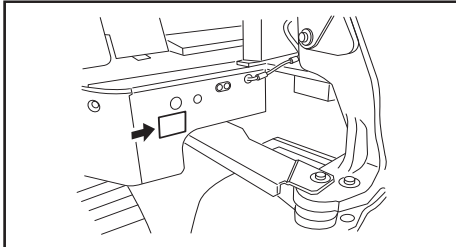

4.1 Location of machine serial number plate

Never remove the plate for any reason.

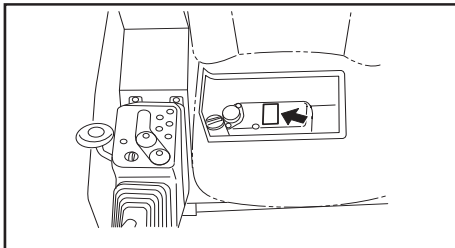

4.2 Location of engine serial number plate

The engine serial number plate is located on the top of the cylinder head cover and on the label on the inside of the engine's bonnet. Never remove the plate for any reason.

4.3 Location of the EPA identification plate

The EPA identification plate is fixed on the engine. Never remove the EPA identification plate for any reason.

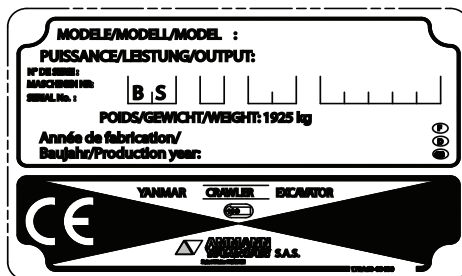

4.4 Ordering replacement parts and service calls

When ordering replacement parts or calling for service, let your dealer know the model designation, the machine serial number, and the engine serial number on the machine serial number plate as well as the reading of the hourmeter.

- Machine serial number plate .



4 Ordering Replacement Parts and Service Call



SAFETY

WARNING

Never attempt to operate or service this machine until you have first read and understood all of the applicable Safety Instructions that are set forth in this Manual.

The failure to comply with all relevant Safety Instructions could result in bodily injury.



5 Basic Precautions

WARNING

It is the user's responsibility to determine if an application presents any dangerous phenomena, for example: toxic gases, ground conditions requiring special precautions and measures to be taken to eliminate or reduce risks.

Follow safety rules at your workplace

- The operation and servicing of this machine is restricted to qualified persons.
- When operating or servicing the machine, follow all the safety rules, precautions and procedures.
- Any work performed by a team or with a signal person should be conducted in accordance with signals agreed on beforehand.

DANGER

The machines are not equipped to operate in explosive environments.

Install safety devices

- Make sure that all guards and covers are installed in their correct position. If any of them are damaged, repair them immediately.
- The proper use of all safety devices, such as lock lever, should be well understood by the machine operator.
- Never remove the safety devices. Always make sure that they operate properly. Incorrect operation of the safety devices could cause serious bodily injury.

Fasten the seatbelt

- For your safety, the machine is equipped with a Roll-Over Protective Structure (ROPS), a Falling Object Protective Structure (FOPS), a Tip-Over Protective Structure (TOPS) and a safety belt on the seat.
- Always fasten the seatbelt and adjust snugly before you operate the machine.
- The seatbelt must be replaced after an accident.
- In addition the seat and seat mounting must be checked by your dealer after an accident has occurred.
- If the seat and seat mounting are damaged, they must be replaced.

5 Basic Precautions

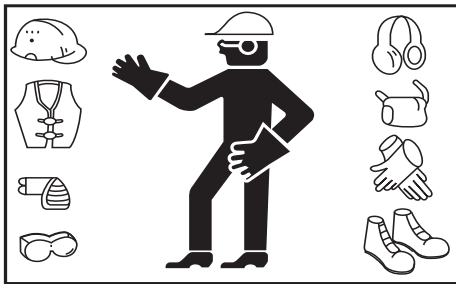

Wear proper clothing and safety items

- Do not wear loose clothing or jewelry that can be caught on the control levers and other machine parts. Also avoid wearing working clothes stained with oil as they can ignite.
- Be sure to wear a helmet, safety goggles, safety shoes, a mask, gloves and other protective items, as appropriate. Take particular precautions when generating metal debris, when striking metal objects with a hammer or when cleaning components with compressed air.
- Also make sure there are no persons near the machine.

Alcohol

- Never operate the machine while you are under the influence of alcohol or when you are ill or feel unwell as this results in accidents.

Provide adequate ventilation when working in an enclosed area

- Engine exhaust fumes are harmful to the human body and their inhalation is extremely hazardous. When starting the engine in an enclosed area, open the windows and doors for ventilation.
- Also do not idle the engine unnecessarily or leave the engine running while the machine is not in use.

Caution for the protection of plants from hot air

- Hot air is exhausted from the muffler and the radiator. If this hot air hits plants directly, they will die.
- Give a cover board to protect plants from the hot air when working near the arranging fence or plant.



Keep fuel and oil away from sources of ignition

- Open flames can ignite fuel, oil, hydraulic oil or antifreeze solutions, which are flammable and dangerous..

Special attention must be paid to the following matters:

- Keep flammable materials away from lighted cigarettes or matches, or any other sources of ignition.
- Never refuel while the engine is running. Smoking during refueling must be strictly prohibited.
- Firmly tighten the caps on the fuel and oil tanks.
- Store fuel and oil in a cool and well-ventilated place where they are not subjected to direct sunlight.
- Fuel and oil must be stored in a place which meets all applicable safety regulations. Unauthorized persons should not be allowed entry.



Avoid removing filler caps while temperatures are high

- The engine coolant, engine oil and hydraulic oil are hot and under pressure immediately after the machine stops operation.
- Removing caps, draining coolant or oil, or replacing a filter at such a time may cause burns. Allow temperatures to cool down and follow the procedures in this manual.
- When removing the radiator cap, stop the engine and allow the coolant to cool down, then turn the cap slowly to relieve all pressures.
- Before removing the cap from the hydraulic oil tank, stop the engine and turn the cap slowly to relieve all pressure to prevent oil from spouting out.

Avoid harmful asbestos dust

- Air containing asbestos dust is carcinogenic and is hazardous to humans. Inhalation of the air may cause lung cancer. When handling materials that may contain asbestos, keep in mind that:
- Compressed air must not be used for cleaning.
- Water must be used to clean the machine to prevent asbestos from scattering in the air.
- You must work on the windward side when operating the machine in a place where there may be asbestos dust.
- You should wear breathing apparatus as necessary.

Prevent crush injuries by the implements

- Keep hands, arms and all other parts of your body away from all the moving parts, particularly between the implements and the machine and between the hydraulic cylinder and the implements, as pinch points are created in those areas.

Keep a fire extinguisher and first aid kit handy

- The workplace must be provided with a fire extinguisher. Read instructions on the label to familiarize yourself with how to use it.
- Keep a first aid kit in a prescribed place.
- Advise what to do in the event of fire or accidents.
- Indicate who to contact in an emergency and keep their telephone number in a prominent place.



5 Basic Precautions

Avoid unauthorized modifications

Precautions for installing optional parts and attachments

- Modifications not recommended by AMMANN YANMAR may cause safety hazards.
- When you wish to modify your machine, contact your dealer. The implementation of unauthorized modifications or the use of unauthorized attachments could result in bodily injury, since those actions would also violate, the terms of AMMANN YANMAR's Warranty, it would be voided.
- When installing or using optional attachments, read the operating instructions for the attachments and the Manual Sections relating to the installation of attachments.
- Use only attachments authorized by AMMANN YANMAR. The use of unauthorized attachments may affect not only the safety of the machine but also the proper operation and life of the machine.
- The use of unauthorized attachments would also violate the terms of AMMANN YANMAR's Warranty, so that it would be voided.

Caution for cabin glass

- If the glass of the cabin should be broken by accident, it is very dangerous since the operator's body might contact the implement directly.
- Immediately stop working to replace the broken glass with a new one.

Emergency escape from operator's cab (for cabin)

- If the door of the cabin should not open, break the window glass with a hammer which is provided inside the cabin to escape from the operator's cab in an emergency.
- Remove the broken pieces of the window glass from the window frame to prevent any injury by those broken pieces. Besides, watch your step not to slip on the broken pieces of the window glass which dropped around your feet.



6 Operating Precautions

6.1 Precautions before starting the engine

Ensure the safety of your workplace

- Before starting the machine, check to see if there are any hazards in your working area.
- Examine the terrain and soil, and decide the best way to do the work.
- When working on the street, provide a signal person or fence for the safety of vehicles and pedestrians.
- If there are underground utilities at the work site, such as water pipes, gas pipes, high-voltage conduits or others, contact the responsible companies to locate them exactly, so as not to damage them.

Inspect around the operator's seat

- Dirt, oil and snow on the floor, levers, handrails or steps are slippery and hazardous. Remove them all completely.
- Keep parts and tools away from the operator's seat as they may damage the control levers or switches or create any other hazards.

Signal before starting the engine

- Check the machine carefully before initial start up for the day.
- Make sure there are no persons near the machine before getting on it.
- Never start the engine when the "SERVICING IN PROGRESS" tag is attached to the control system.
- Sound the horn to alert people nearby before starting the engine.
- Be sure to start the engine and operate the machine from the operator's seat only.
- Do not allow any other persons to get on the machine.

Keep the headlights clean

- Keep the surface of the headlights clean for clear view.
- Make sure that your machine is equipped with headlights and all required working lamps, and that they work properly.

6 Operating Precautions

CAUTION

The headlight gets hot when it is turned on. Do not touch it carelessly with your bare hand to prevent burns.

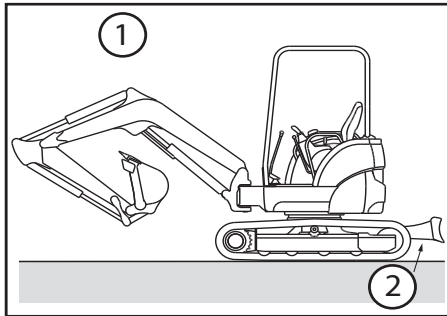

Check the position of the blade before operating the machine

- Check the position of the blade before operating the travel levers. When the blade is located in the back, the operation of the travel levers is reversed.

- (1) Traveling in reverse
- (2) Blade

ROPS / FOPS / TOPS

- Never modify the structural member of ROPS / FOPS / TOPS.
- If ROPS / FOPS / TOPS is damaged, replace it immediately to prevent bodily injury. Never repair or modify it.

6.2 Precautions when traveling

Make sure there are no persons nearby when turning or reversing the machine

- A signal person should be provided for safety when the work site is hazardous or when visibility is poor.
- Keep all other persons away from the work site or the traveling path of the machine.
- Alert persons nearby with a horn or other signal before starting the machine.
- The machine permits a limited range of vision toward the rear. Make sure there are no persons behind the machine before reversing.

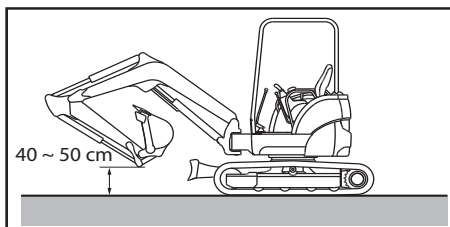

Precautions for traveling

- When traveling with the machine, keep the bucket 40 to 50 cm above the ground with boom and arm folded as illustrated below.
- If you need to operate the control levers while traveling, never move them abruptly.

6 Operating Precautions

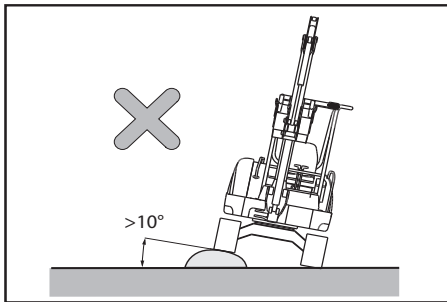

- Travel the machine at a low speed and slow down when turning on rough terrain.
- Avoid running over obstacles if possible. If unavoidable, run the machine at a low speed while keeping the implement close to the ground. Never run over obstacles that may cause the machine to tilt more than 10 degrees.

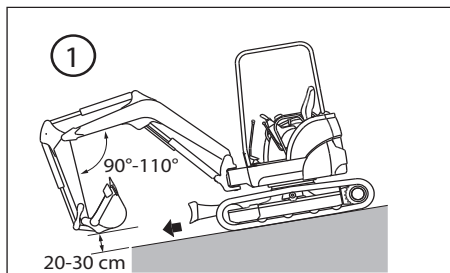

Running the machine on a slope

- Run the machine carefully on a slope to avoid overturning or skidding sideways.
- When running the machine on a slope, keep the bucket 20 to 30 cm above the ground so that you can immediately lower it to the ground and stop the machine in an emergency.
- Never turn the machine on a slope or run it across the slope.
- Move down to flat ground and then make a turn.
- On grasses, dead leaves or a wet metal plate, even with a slight gradient, the machine will easily slip. Under those circumstances, run the machine carefully at low speed to prevent it from skidding.

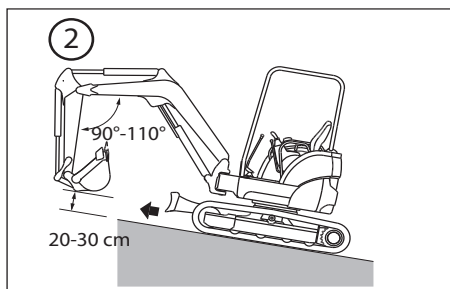

- (1) Going down a slope
(2) Going up a slope

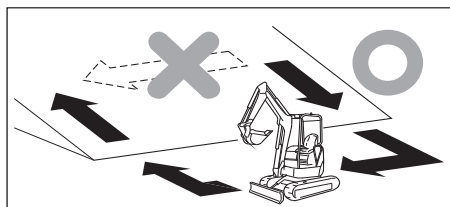

Note: For the maximum accepted gradient, refer to the specification table.

Braking when going down a slope

- When going down a slope, you can automatically brake the machine by setting the travel levers to the neutral position.

When the crawler is slipping

- If you cannot climb a slope by operating the travel levers because the crawler is slipping, retract the arm and make use of the pull-back power of the implement to climb the slope.

When the engine stops

- If the engine stops while climbing a slope, set the travel levers to the neutral position, stop the machine, and restart the engine.

6 Operating Precautions

6.3 Precautions when working

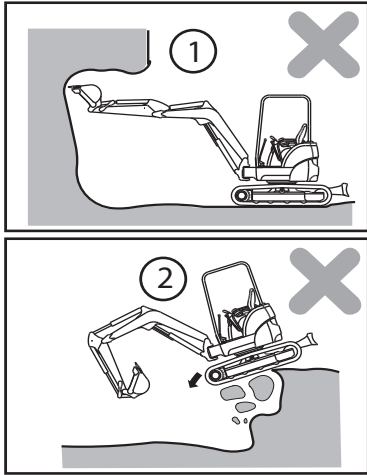

Avoid hazardous work

- Undermining a cliff is dangerous as it may cause a rockslide or landslide.
- Undercutting the machine is dangerous as it may cause a cave-in, resulting in the machine overturning and falling into the excavation.

- (1) Undermining
(2) Under cutting

DANGER

Keep away from electric power lines

- Working in the vicinity of overhead electric power lines presents a very serious hazard and special precautions must be taken. For purposes of this manual you are considered to be working in the vicinity of overhead power lines when the attachment or load of your machine, in any position, can reach to within the minimum distances shown in the table.
- The following procedures are effective in preventing accidents or injuries.
 - 1) Wear shoes with rubber soles.
 - 2) Use a signal person to warn the operator when the machine is getting too close to a power line.
- If the machine should contact a wire, the operator must not leave the seat.
- When working near power lines, caution all ground personnel to stand clear of the machine.
- To determine the transmission voltage at the working site, contact the electric utility concerned.

	Transmission voltage (V)	Minimum safe distance (m)
Power distribution	100/200 or less	2 or more
	6600 or less	2 or more
Transmission line	22000 or less	3 or more
	66000 or less	4 or more
	154000 or less	5 or more
	275000 or less	7 or more

Prevent bumping the implements

- When traveling through tunnels or under bridges, or working at a site near other overhead obstacles, operate the machine carefully so as not to bump the boom, arm, or the implement against those overhead obstacles.

Work only where visibility is good

- When working in a dark place, light up the area with the work lights and head lights, and prepare extra lighting equipment as necessary.
- Stop working when fog, snow or rain impedes your view.

Work carefully in a snow-covered areas

- A snow-covered ground and icy roads are dangerous as they may cause the machine to skid even on a slight slope. Run the machine at low speed, and never start, stop or turn abruptly on such ground or under such road conditions.
- Be careful removing snow as road shoulders or other hazards may be buried under snow.

Unstable ground creates a high possibility of overturn

- Keep away from cliffs, road shoulders or trenches if possible as the ground near them is unstable. The ground may crumble due to the weight or vibrations of the machine, resulting in an overturn or fall of the machine. Be particularly careful when working immediately after rainstorm or after blasting as the ground may be unstable.
- Ground-fills or ground near a ditch may be unstable and may crumble due to the weight or vibrations of the machine, causing the machine to tilt. Much caution must be taken in working in these areas.
- When working in an area where there is a high possibility of falling rocks, wear a hard-hat and stay under the canopy.

Allowable water depth

IMPORTANT

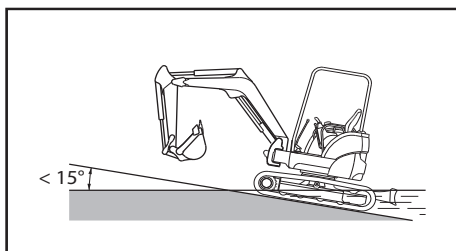

When driving out of water, if the machine climbs a slope at an angle of more than 15 degrees, the rear of the upperstructure may submerge too deeply in the water, which may damage the radiator fan since the radiator fan paddles the water. Avoid this if possible when driving out of water.

6 Operating Precautions

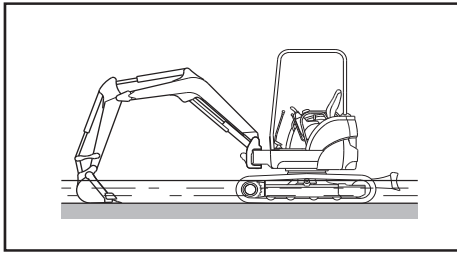

- The limit of the water depth in which the machine can be used in is up to the center of the shoe slide plate.
- Apply a generous amount of grease to the moving parts (especially bucket pin) that have been submerged in the water for a long time until the used grease is extruded out of the bearings.
- Wipe the extruded used grease off with a waste cloth.

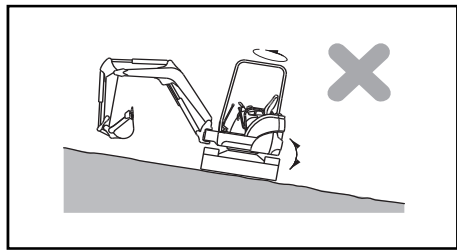

Working on a slope

- Be aware that the machine may tip over when swinging the upperstructure or swinging the implement on a slope.
- Never swing the upperstructure toward the downward side of the slope with earth loaded in the bucket. (See the illustration)
- If swinging is unavoidable, level off a work area to maintain the machine as horizontal as possible, then swing. (See the illustration)

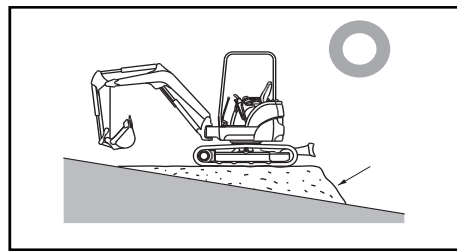

Note: For the maximum accepted gradient, refer to the specification table.

6.4 Precautions for parking

Parking the machine

- Park on level ground. If park on a slope is unavoidable, block the tracks with solid pieces of wood and dig the bucket into the ground. (See the illustration)
- If necessary to park the machine on the side of a road, set up a warning flag, fence, or lamp that can be easily recognized by passing cars and pedestrians but does not impede them.

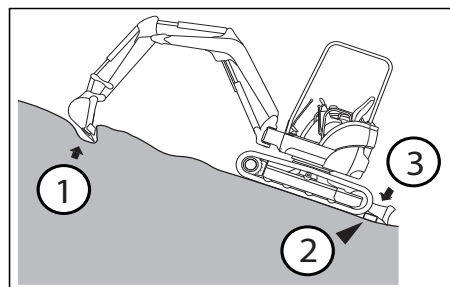

- (1) Dig the bucket into the ground
- (2) Block
- (3) Place the blade on the ground

CAUTION

- Do not touch the control levers accidentally. Otherwise, the implement or the machine may move unexpectedly, causing a serious accident.
- When leaving the operator's seat, be sure to place the lock levers securely in the lock position and remove the starter switch key.

6 Operating Precautions

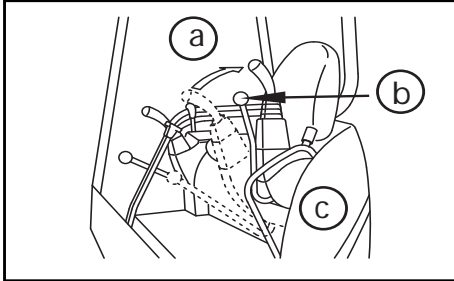

- 1) Set the left and right travel levers to the neutral position to stop the machine.
 - 2) Idle the engine with the accelerator lever.
 - 3) Place the bucket on the ground with its bottom surface in contact with the ground.
 - 4) Place the blade on the ground.
 - 5) Set the lock levers to the "LOCK" position.
- (a) Lock
(b) Lock lever
(c) Left side

Use handrails and steps when getting on and off

- Do not jump on or off the machine. Never get on or off a machine in motion as it may result in bodily injury.
- When getting on and off the machine, face the machine and use the handrails and steps.
- Do not use control levers as handrails.
- Make sure that you maintain three point contact with the handrails or the steps.
- If the handrails and the steps are soiled with oil or dirt, clean them off immediately. Repair any damaged parts and retighten any loose bolts.

6.5 Attachment precautions

WARNING

Be careful when setting up and dismantling the attachments. An attachment not adapted to the machine can destabilise it.

When you install or remove the attachments, comply with the following precautions:

- Place the machine on hard, flat ground.
- Shutdown the engine.
- Keep the parts clean and well lubricated.
- Never install attachments that exceed the maximum accepted overall dimensions.
- Never stand under a suspended load.

It is recommended that the user acquaint himself with and retain the instructions relating to the installation and use of the attachment.

6 Operating Precautions

6.6 Precautions for transportation

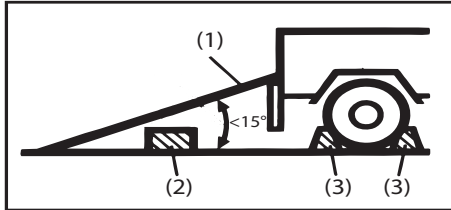

Precautions for loading and unloading the machine

- (1) Ramp plate
- (2) Block
- (3) Stoppers

- Be careful in loading and unloading the machine, because it is a job of high hazard potential.
- Load or unload the machine at a low engine speed, and low travel speed.
- Load or unload the machine on the level, solid ground away from the shoulder of the road.
- Use ramp plates of adequate strength with hooks on their ends.
- Check to see that the ramp plates are wide, long, and thick enough to sustain the load so that you can load or unload the machine safely. Support the ramp plates with blocks, to provide additional strength.
- Securely hook the ramp plates to the deck of the truck so that they will not come off.
- Remove grease, oil, and other slippery deposits from the ramp plates, and remove mud from the tracks to prevent the machine from skidding on the ramp plates.
- Do not load or unload the machine if the ramp plates are slippery because of rain, snow or ice.
- Never change travel direction while on the ramp plates. If you need to change travel direction, go down the ramp plates, and change direction on the ground.
- After loading the machine, block it with lumber and secure the machine with a chain or a wire rope so that the machine will not move during transit. (Refer to Chap. 12.2 'Machine tie-down' in this manual.)

Precautions for transporting

- Transport the machine safely in accordance with the laws associated with applicable law.
- Select a travel route consistent with the width, height and weight of the machine loaded on the truck.

CAUTION

Load or unload the machine on level, solid ground far away from the shoulder of the road.

6 Operating Precautions

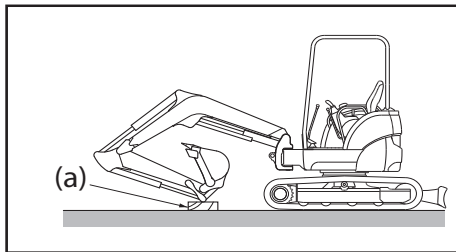

After loading the machine in a safe position on the truck, secure the machine as follows:

- 1) Place the blade down on the ground.
- 2) Extend the bucket and arm cylinders to the maximum limit, and slowly lower the boom down on a block of wood (a).
- 3) Stop the engine and take the key out of the starter switch. (The brake works to lock the swing motor.)
- 4) Be sure to lock the control levers with the lock levers.
- 5) Provide wood blocks in the front and back of the crawler and secure the machine with a chain or a wire rope so that the machine will not move during shipping. In particular, be sure to secure it to prevent skidding.

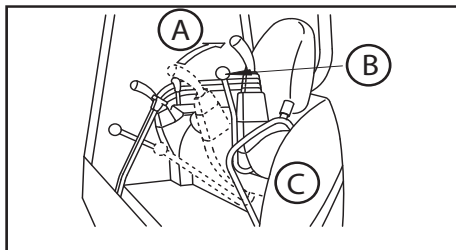

A = Locked
B = Lock lever
C = Left side
D = Blocks
E = Belts

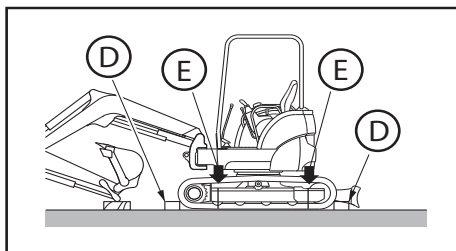

IMPORTANT

To protect the bucket cylinder from being damaged during shipping, place a wooden block under one end of the bucket to prevent it from directly touching the deck of the truck.

6.7 Precautions for the battery

DANGER

Be careful in handling the battery

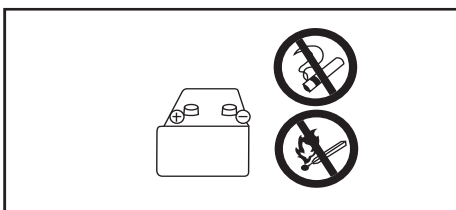

- The battery electrolyte contains dilute sulfuric acid, which can severely burn the eyes or skin. Always wear safety goggles and protective clothing when servicing the battery. If contact with the eyes or skin should occur, flush with a large amount of water and obtain prompt medical treatment.
- Because flammable hydrogen gas is produced by the battery, ignition and explosion may occur. Keep flames and sparks away from the battery.
- If you swallow battery electrolyte by mistake, drink a large amount of water, milk, or fresh eggs, and obtain medical treatment immediately.





6 Operating Precautions

- Before checking or handling the battery, be sure to stop the engine and turn the starter switch to the "OFF" position.
- Be careful not to cause a short circuit by placing a tool across the terminals of the battery.
- If a terminal connection is loose, sparks may be generated due to contact failure, causing possible ignition and explosion. Be sure to connect the terminals securely.

ATTENTION

Observe the procedures for starting the engine using booster cables

- When you start the engine using booster cables, wear safety goggles.
- If you start the engine by taking electric power from another machine, do not allow your machine to contact the other machine.
- To connect the booster cables, begin with the positive terminal, and to disconnect them, begin with the negative terminal (ground side).
- If a tool simultaneously touches the positive terminal and the machine, potentially hazardous sparks may be generated.
- Do not connect the booster cables to the terminals in reverse polarity. In other words, never connect the negative terminal on one machine to the positive terminal on the other machine.
- As the last step, connect the negative booster cable terminal to the upper structure frame. At that time, sparks will be generated. Consequently, connect the terminal to a point as far away from the battery as possible.



7 Precautions for Servicing

7.1 Precautions before servicing

- Attach the "SERVICING IN PROGRESS" tag to an implement control lever.
- If another person should start the engine or operate the control levers while service is in progress, the service personnel can sustain serious bodily injury.
- Attach the "SERVICING IN PROGRESS" tag indicating "Servicing in Progress" to one of the implement control levers.

Use appropriate tools

- Using damaged or worn tools or using tools inappropriate for the required application is very dangerous, and may also cause damage to the machine. Make sure to use the tools that are appropriate for the specific job.

7.2 Replacing Essential Parts Periodically

- For safe operation, the machine must be serviced periodically. To increase safety, be sure to periodically replace the parts listed in the table of safety parts on the next page. A fire could result if they deteriorate or are damaged.
- These parts are vulnerable to age and wear or deterioration and it is difficult to determine the degree to which they have deteriorated on the occasion of periodic service. To maintain their proper function at all times, therefore, replace them with new ones after using them for a specific period of time even if no abnormality is found with the parts.
- If you find abnormalities in these parts before their scheduled replacement time is reached, repair or replace them immediately.
- If a hose clamp is deformed or cracked, replace it immediately.
- Check the hydraulic hoses (which are not periodic replacement parts). If any abnormality is found in them, retighten them or replace them immediately.
- When replacing the hydraulic hoses, replace the O-rings and seals at the same time.
- For further information about replacing the safety parts, ask your dealer.



7 Precautions for Servicing

- Check the fuel and hydraulic hoses according to the periodic schedule described below.

Check categories	Check points
Start-up check	Oil leak from the connections or bodies of the fuel and hydraulic hoses
Voluntary monthly check	Oil leak from the connections or bodies of the fuel and hydraulic hoses Damage (crack, wear, or peeling) of the fuel and hydraulic hoses
Prescribed annual check	Oil leak from the connections or bodies of the fuel and hydraulic hoses Interference, crushing, aging, torsion, or damage (crack, wear, or peeling) of the fuel and hydraulic hoses

List of safety parts

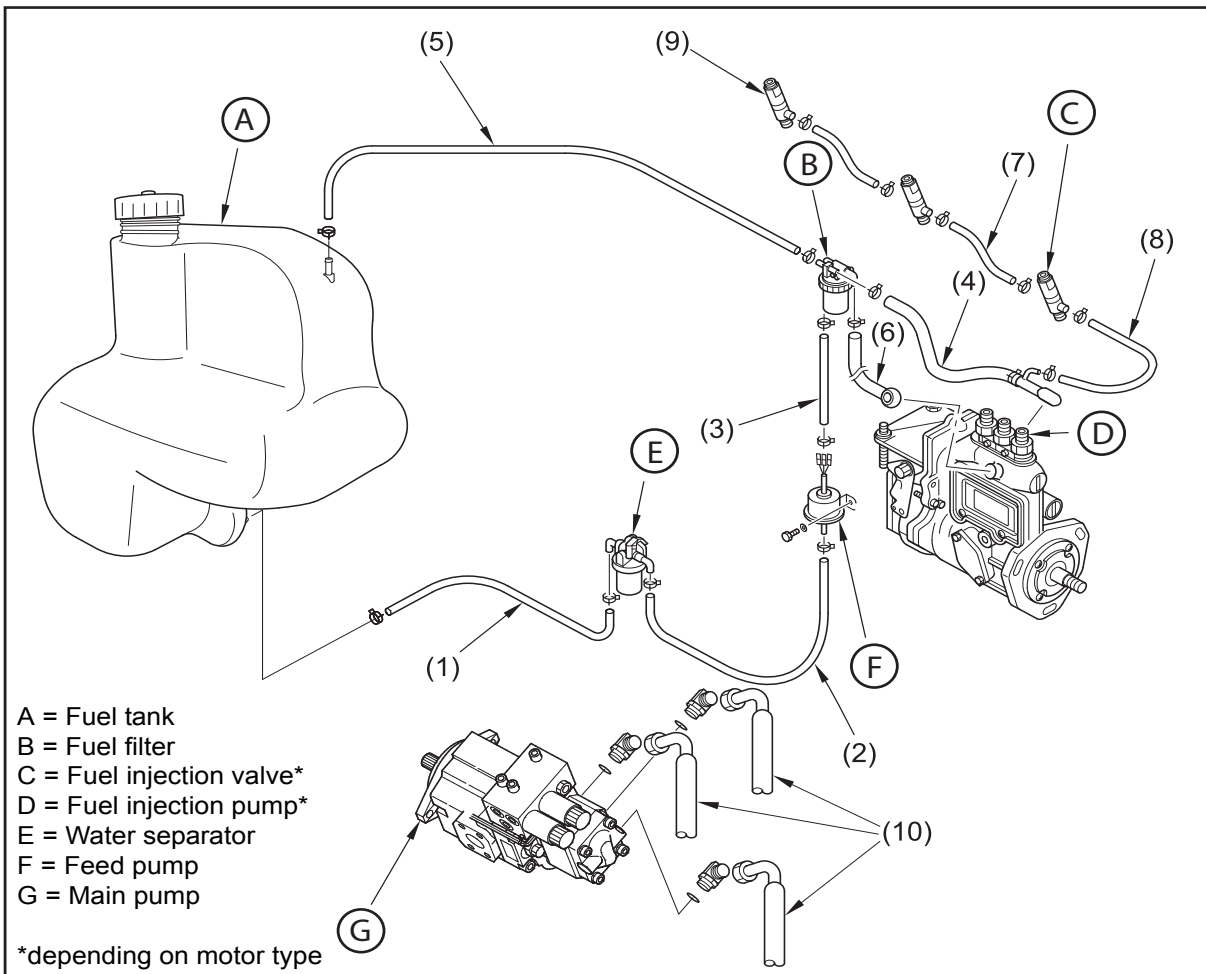

7 Precautions for Servicing

No.	Safety parts to be replaced periodically	Qté	Replacement time intervals
1	Fuel hose (fuel tank to water separator)	1	Earlier of either every 2 years or every 4000 service hours
2	Fuel hose (water separator to feed pump)	1	
3	Fuel hose (feed pump to fuel filter)	1	
4	Fuel hose (fuel filter to fuel injection pump)	1	
5	Fuel hose (fuel filter to fuel tank)	1	
6	Fuel hose (fuel injection pump to fuel filter)	1	
7	Fuel hose (fuel injection valve to fuel injection valve)	2	
8	Fuel hose (fuel injection valve to fuel injection pump)	1	
9	Fuel tube cap	1	
10	Main pump outlet hose (P1, P2, P3)	3	

Stop the engine before beginning the inspection and servicing

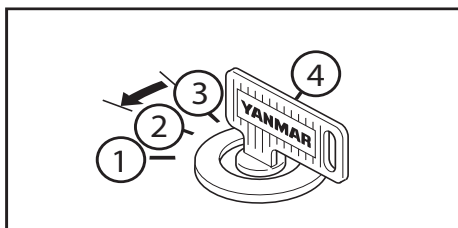

- Be sure to stop the engine before performing inspection and servicing.

- 1) Pre-heat
- 2) Off
- 3) On
- 4) Start

- If necessary to perform service while running the engine, as when cleaning the inside of the radiator, be sure to set the lock lever to the lock position and do the job together with a partner.

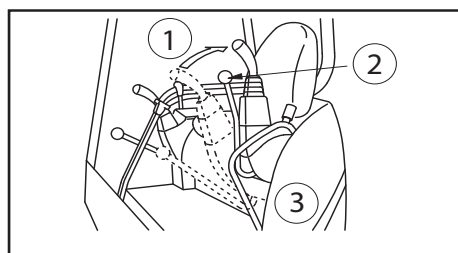

a = Lock

b = Lock lever

c = Left side

- (One should take the operator's seat so that he or she can stop the engine at any time.)
- That person must be careful not to touch any levers in the cabin.
- Be extremely careful not to contact the moving fan or fan or fan belt, or any hot surfaces.



7 Precautions for Servicing

7.3 Precautions during servicing

Keep unauthorized persons away

- Never admit any persons into the work area who are not taking part in the work. Be conscious of the safety of other persons.
- Be especially careful when grinding, welding, or using a large hammer.

Removed attachments

- When an attachment is placed on the ground or against a wall after removing it or prior to reinstalling it, be sure that it is stable to prevent it from falling down.

Working under the machine

- Before performing service or repairs underneath the machine, place the implement on the ground in its lowest position.
- Be sure to apply blocks to the tracks to lock the tracks securely.
- Never perform service underneath the machine if it is not completely stable.

Pressure equipment (accumulator)

- The machines are equipped with an accumulator. This pressure equipment complies with the prescriptions of Article 3 Paragraph 3 of the European directive (97/23/CE) on pressure equipment. In view of Article 3 Paragraph 3, the acronym EU cannot be affixed on this device.
- The pressure equipment (accumulator) is pressurized. Repair, maintenance and commissioning must be done only by qualified personnel.
- Do not open and carry out modifications to the pressure equipment.

Keep the machine clean

- Spilled oil or grease, or scattered parts are dangerous and can cause falls. Keep the machine clean.
- Getting water into the electrical system may cause it to malfunction, resulting in faulty operation of the machine. Also it may permit electrical leaks that could cause a fire or electric shocks.
- Never clean the sensors, connectors or the operator's seat with water or steam.



7 Precautions for Servicing

Radiator cooling water level

- Before checking the radiator cooling water level, stop the engine and wait until the engine and the radiator have cooled down.
- Slowly loosen the cap to release the inner pressure before removing the cap.

Use an explosion-proof lighting source

- Use an explosion-proof lighting source when checking the fuel, the oil, the cooling water, or the battery electrolyte. Failure to use an explosion-proof lighting source may cause ignition to occur, inducing an explosion.

Precautions for handling battery

- When welding or repairing the electrical system, disconnect the negative terminal of the battery to interrupt the electric circuit.

Handling high-pressure hoses

- Leaks of fuel and oil could cause a fire.
- Do not bend a high-pressure hose forcibly, or strike it with a hard object. Because abnormally bent or damaged piping, tubes, and hoses easily burst under high pressure, never use them.

Be careful of hot oil under high-pressure

- The hydraulic system for the implement operates under high pressure. When replenishing or draining hydraulic oil, be sure to first relieve the high pressure.
- The emission of hot oil under high-pressure from a small leak could result in serious bodily injury. Wear safety goggles and thick gloves when checking for leaks. Use a piece of cardboard or a plywood block to detect emissions of hot oil.
- If the hot oil should contact your body, obtain prompt medical treatment.

Hazards from the high-pressure grease when adjusting the track crawler tension

High-pressure grease is enclosed in the track crawler adjuster. Failure to use the specified procedures for adjusting the track crawler tension, could cause grease plugs or nipples to eject, which could result in bodily injury.

- Do not loosen the grease draining plug more than one turn.
- Never position your face, hands, legs, or body in line with the grease draining plug and valve.



7 Precautions for Servicing

Rotating radiator fan and fan belt

- Never contact the rotating radiator fan or fan belt with any object.
- Contacting the rotating radiator fan or fan belt with any object can result in serious bodily injury.

Processing wastes

- Do not dispose of waste oil in the sanitary sewer system.
- Always drain the oil from the machine into a secure container, and never directly to the ground.
- When disposing of toxic wastes such as fuel, oil, cooling water, solvent, filters, and spent batteries, comply with all applicable disposal regulations.



8 Safety Messages (Warning Labels)

There are a number of Warning Labels on the machine. Full descriptions of all Warning Labels and their locations are reviewed in this section. Periodically confirm whether all Warning Labels are still mounted in their correct locations and can be easily read.

If a warning label is missing, damaged or cannot be read, it must be promptly replaced. Also, if a warning label was mounted on a part which is replaced, a new warning label must be installed on the replaced part.

Contact your dealer to obtain new labels. The part code number is shown on each warning label.

8 Safety Messages (Warning Labels)

8.1 Location of warning labels
(depending on model)

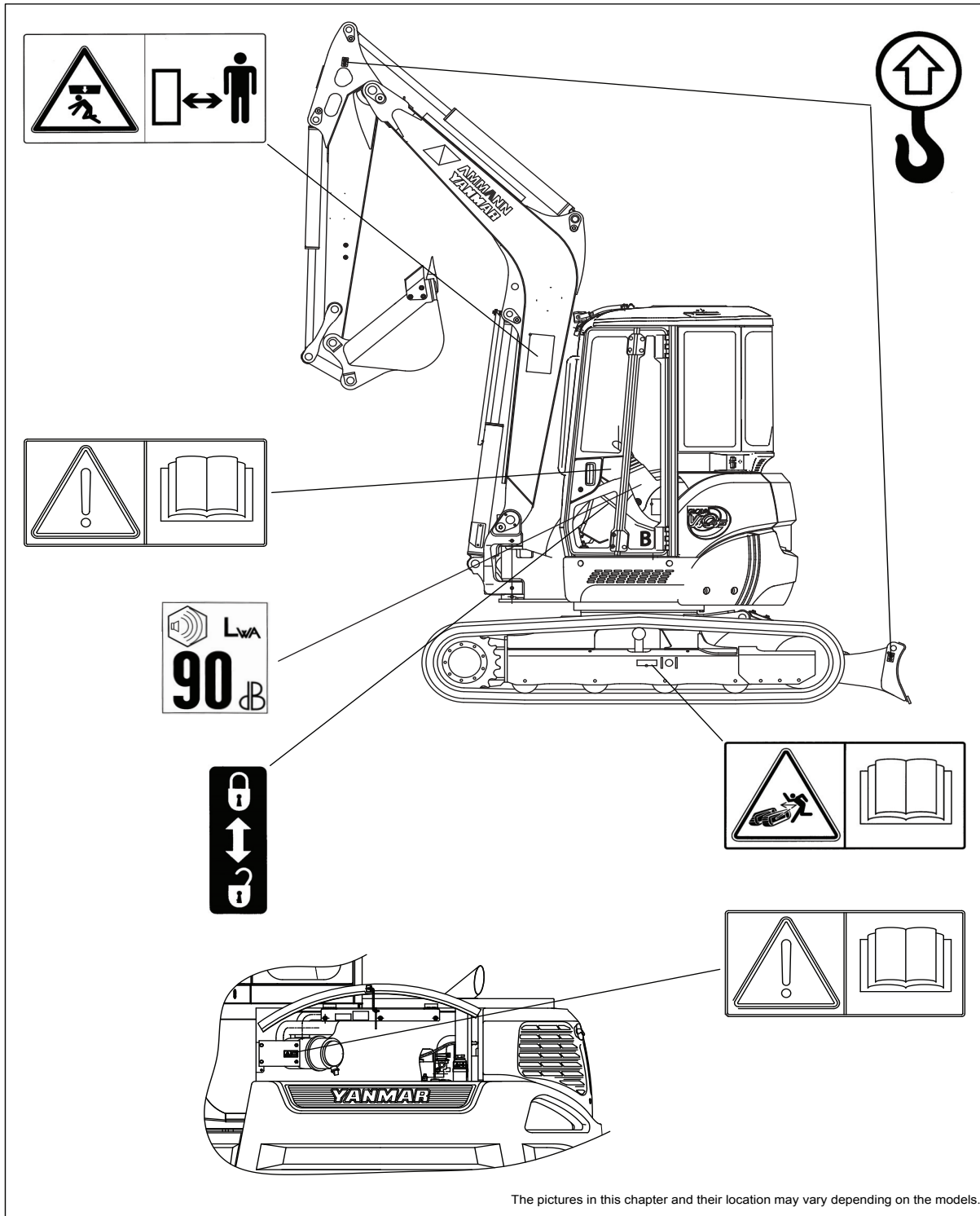

8 Safety Messages (Warning Labels)

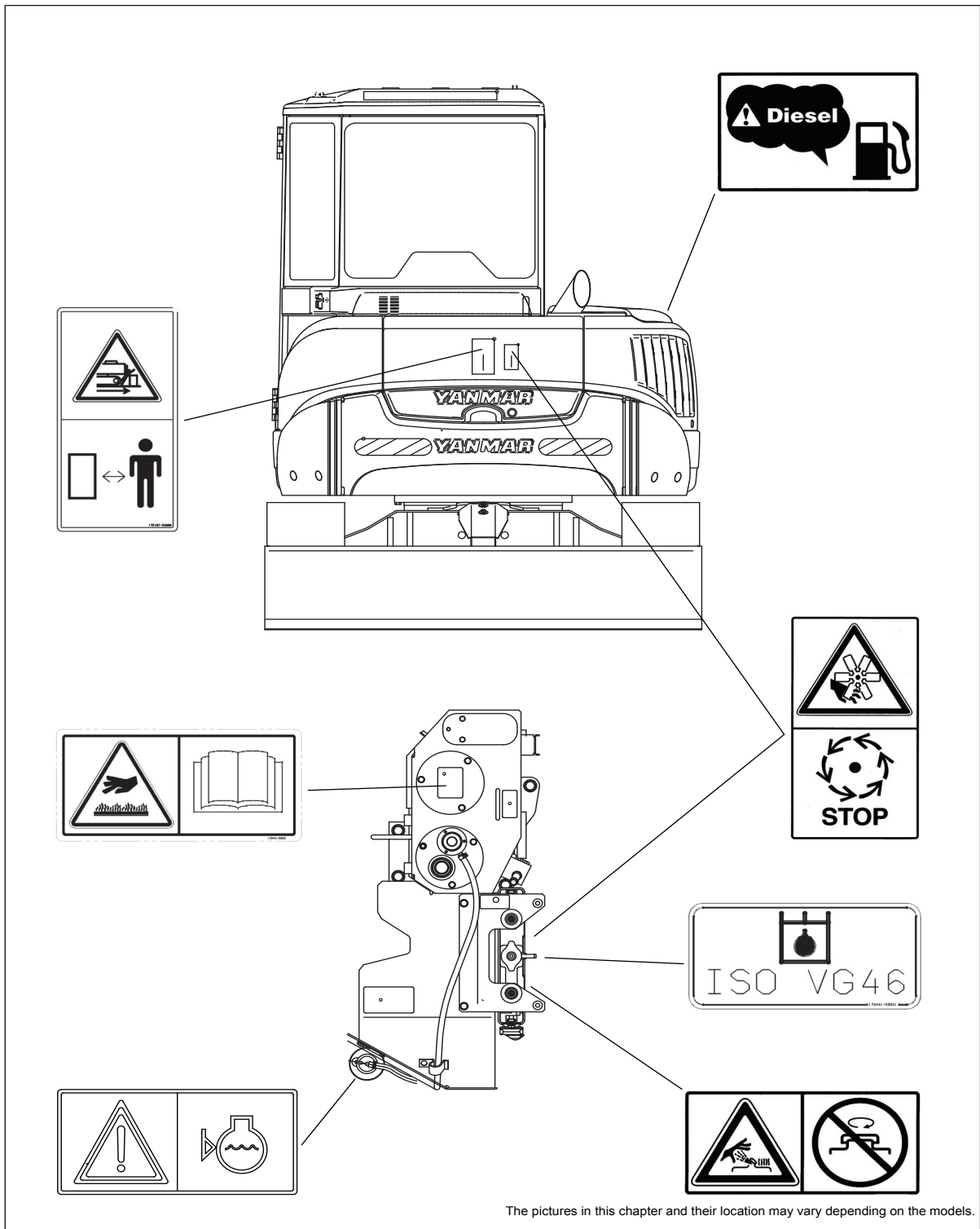

The pictures in this chapter and their location may vary depending on the models.



8 Safety Messages (Warning Labels)



OPERATION



9 Identification of Important Parts

9.1 Overview of the machine

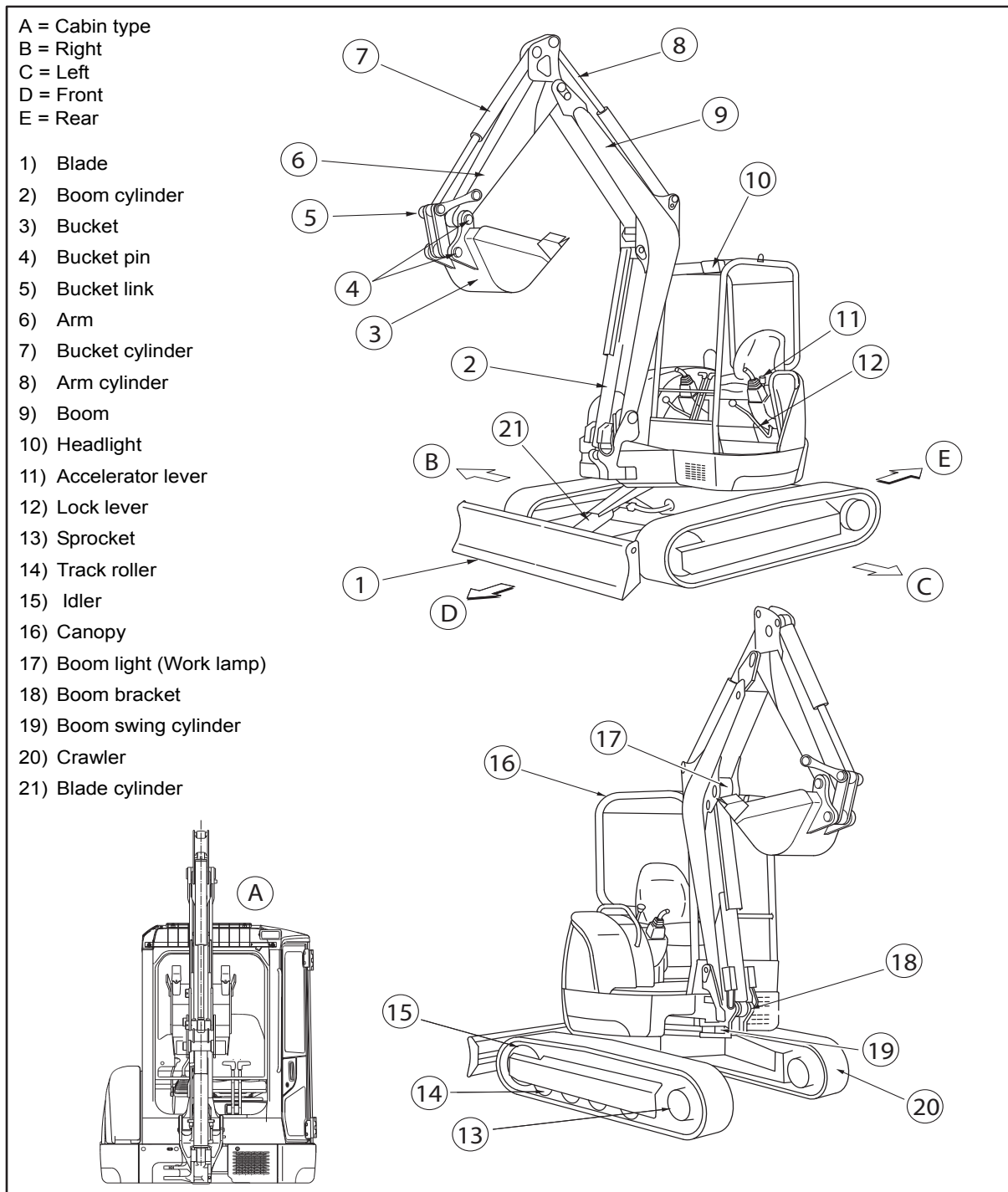

9 Identification of Important Parts

9.2 Controls and switches (depending on model)

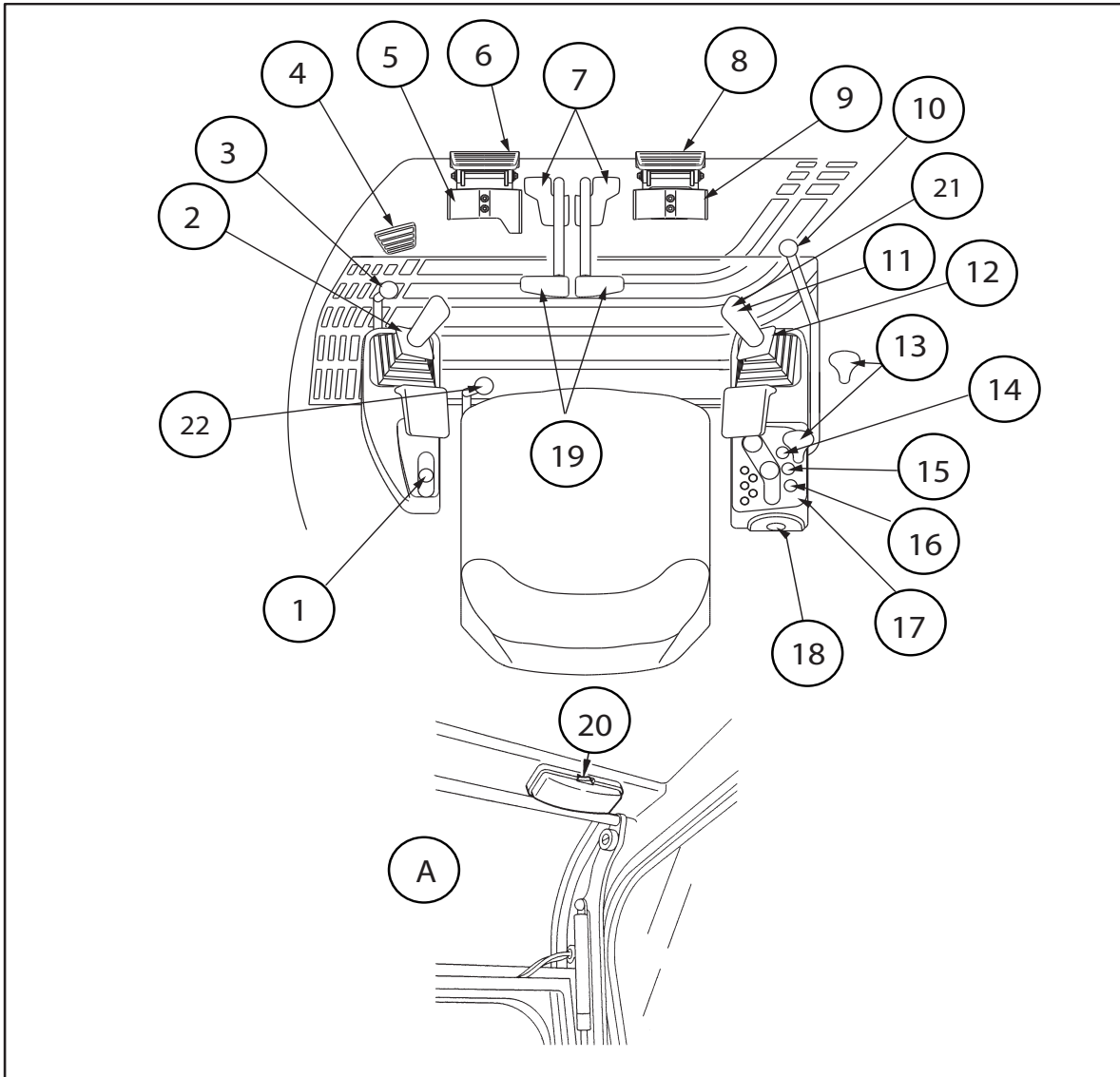

A = For cabin type

- | | | |
|---|---|---|
| 1) Accelerator lever | 9) Boom swing pedal | 17) Monitor |
| 2) Control lever (L) | 10) Lock lever (only for canopy type) | 18) Starter switch |
| 3) Lock lever | 11) Horn switch | 19) Travel lever |
| 4) 2nd speed pedal | 12) Control lever (R) | 20) Room lamp switch |
| 5) P.T.O. pedal/switch (depending on model) | 13) Blade lever (location depending on model) | 21) P.T.O. -switch (depending on model) |
| 6) Pedal guard | 14) Light switch | 22) Track spacing lever (for ViO17) |
| 7) Travel pedal | 15) Wiper switch (for cabin type) | |
| 8) Pedal guard | 16) Heater switch (for cabin type) | |

10 Description of operator's area

This section describes several of the control devices necessary to operate the machine. In order to ensure safety and comfort in working with the machine, it is imperative for you to fully understand how to operate and interact with these devices.

10.1 Monitor (depending on model)

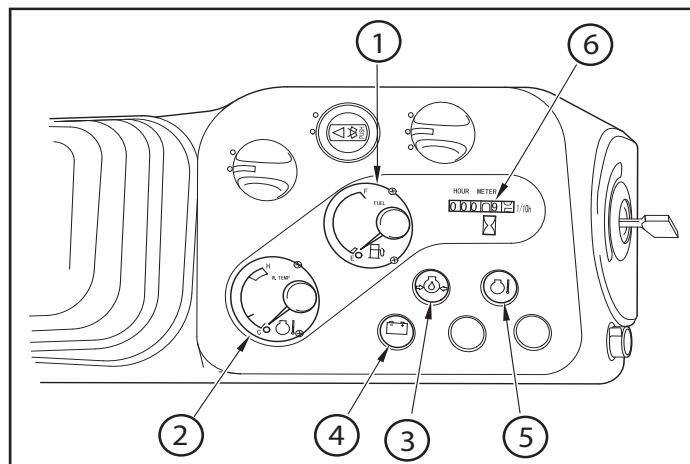

- 1) Fuel gauge
- 2) Water temp meter
- 3) Engine oil pressure alarm lamp
- 4) Battery charge alarm lamp
- 5) Water temp alarm lamp
- 6) Hourmeter

CAUTION

When an indicator lamp lights and a buzzer sounds during operation, immediately stop operation and check and service the abnormality.

When the starter switch key is in the "ON" position, the monitor lamps (3), (4) and (5) light and buzzer sounds. (Only the water temp alarm lamp (5) goes off in a few seconds.)

Normally, all monitor lamps go off after the engine starts. When there is any failure during operation, a lamp lights and buzzer sounds. (If the starter switch key is in the "ON" position and a monitor lamp does not light, its bulb must be burnt out.)

10 Description of operator's area

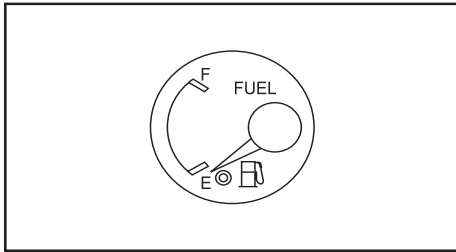

(1) Fuel gauge

The fuel gauge works while the starter switch key is in the "ON" position and indicates the fuel amount in the fuel tank.

- It is not abnormal that the fuel gauge may not indicate properly immediately after the starter switch key is turned to the "ON" position.
- The reading on the fuel meter scale is affected by how much the machine is slanted.

F = Full
E = Empty

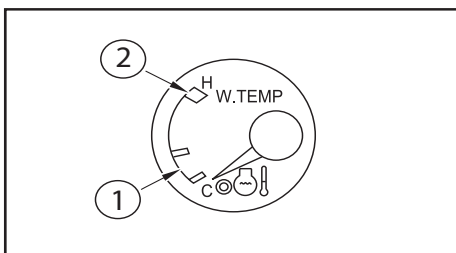

(2) Water temp meter

This indicates water temperature for engine. During operation, the normal water temperature is within the limit (1). When the cooling water temperature rises till the limit (2) during operation, idle the engine at low speed until the water temperature cools down.

1 = White
2 = Red

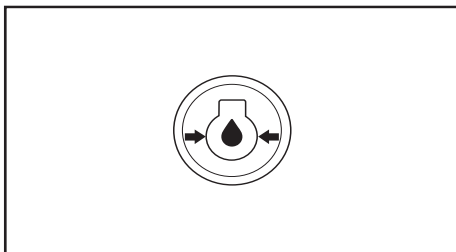

(3) Engine oil pressure alarm lamp

If engine oil pressure falls below the normal level, the alarm lamp will turn on and the buzzer will sound. In this event, stop the engine and inspect it.

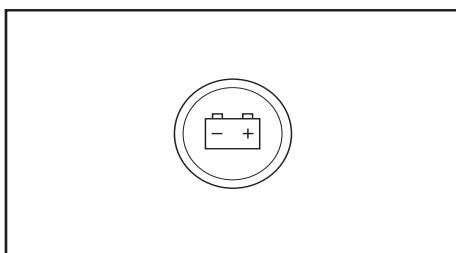

(4) Battery charge alarm lamp

If the battery is not charged properly, the alarm lamp will flash. In this event, inspect the battery charging circuit. If you find something abnormal with it, take corrective action.

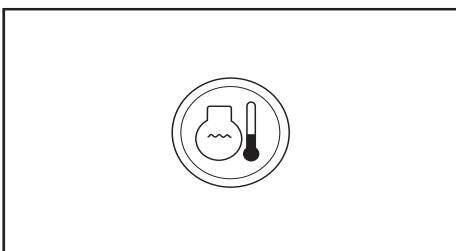

(5) Water temp. alarm lamp

When the starter switch is turned to the "ON" position, the alarm lamp goes on and then goes off in a few seconds. When the cooling water temperature rises abnormally during operation, the alarm lamp goes on and the buzzer sounds, indicating engine overheating.

Idle the engine for a while, and stop the engine. After the engine has cooled, take corrective actions.

10 Description of operator's area

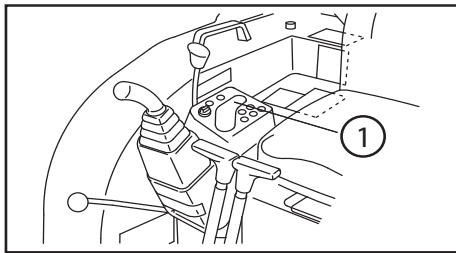

(6)Hourmeter

The hourmeter indicates the accumulated service hours for the machine.

The reading of the hourmeter helps you set time intervals for periodic servicing of the machine. While the engine is running, the hourmeter will continue registering even if the machine is not being operated.

- The hourmeter registers "1" per hour regardless of engine rotational speed. The digit at the far right registers "1" per 0.1 hour (6 min.).

1 = Hourmeter

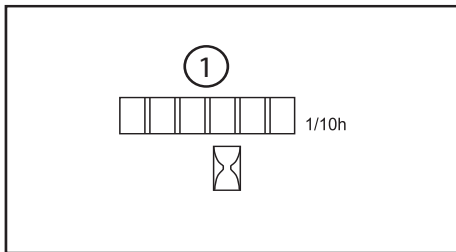

10.2 Switch (depending on model)

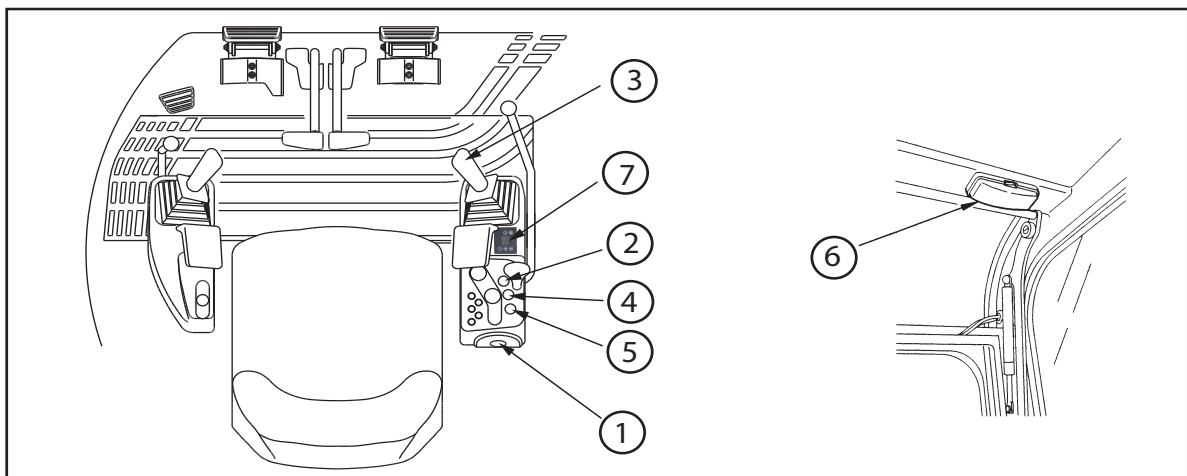

- 1) Starter switch
- 2) Light switch
- 3) Horn switch
- 4) Wiper and windshield washer switch (for cabin)
- 5) Heater switch (for cabin)
- 6) Room lamp switch (for cabin)
- 7) Air conditioning heater (depending on model)

10 Description of operator's area

(1) Starter switch

Use this switch to start and stop the engine.

- OFF position
Turn the key to "OFF" to stop the engine and disconnect electrical circuit or remove the key.
- ON position
Turn the key to "ON" to connect the electrical fuel solenoid circuit and the electrical charging circuit. (Keep the key in this position while running the engine.)
- START position
Turn the key to "START" to start the engine. Release the key after the engine is started and it will return to the "ON" position.
- AIR HEATER position
Turn the key to activate the preheating circuit and warm up intake air to start the engine easier in cold weather. (Set the key to this position when the outside temperature is low.)
- When the engine is not running and the switch is in the "ON" position, the buzzer keeps sounding.
Turn the switch to the "OFF" position to stop sounding.

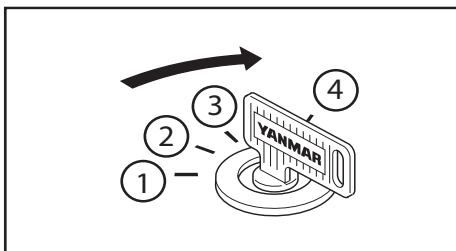

- 1) Air heater
- 2) Off
- 3) On
- 4) Start

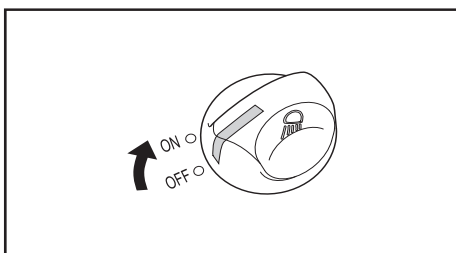

(2) Light switch

The boom light and the headlight go on when the switch is turned on with the starter switch set to the "ON" position.

- ON : The lamps go on.
- OFF : The lamps go off.

IMPORTANT

Do not keep the lamps on for a long time while the engine is not running. The battery runs down and the engine cannot be started.

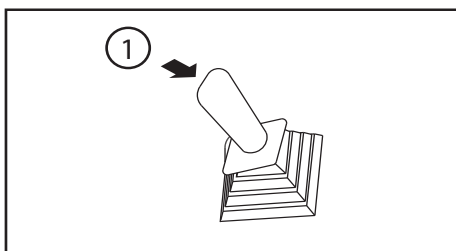

(3) Horn switch

Press the switch on the top of the right control lever (1) to sound the horn.

10 Description of operator's area

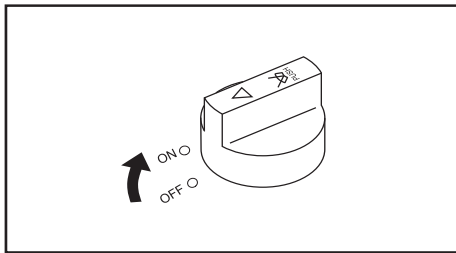

(4) Wiper and windshield washer switch (for cabin)

This switch serves both wiper switch and windshield washer switch.

Wiper (for cabin):

Move the switch to the "ON" position to actuate the wiper of the windshield.

- ON : Wiper works.
- OFF : Wiper stops.

Windshield washer (for cabin):

Push the wiper switch.

The windshield will be sprayed with windshield washer fluid.

IMPORTANT

- Do not push the switch when the tank is empty, it could cause pump failure.
- Wiping the windshield when dry could damage the glass. Use the wiper only when the windshield is wet.
- The wiper blade may freeze in cold weather. Do not attempt to move it; otherwise the wiper motor will be damaged.

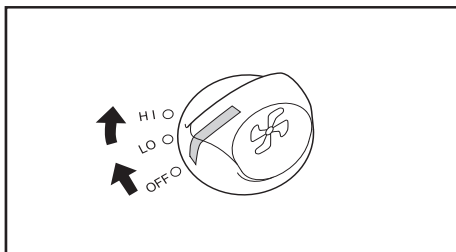

(5) Heater switch (for cabin)

Use this switch to warm up the air in cabin. Move the switch to select fan speed. The heater switch allows you to select a high or low draft volume by setting it as follows:

- LO : Low fan speed.
- HI : High fan speed.
- OFF : Off.

Operate the heater switch after the cooling water has warmed up.

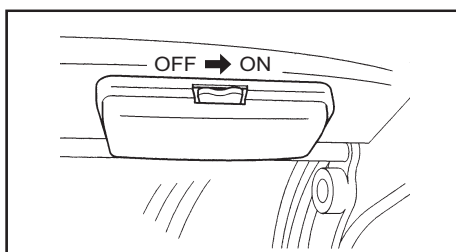

(6) Room lamp switch (for cabin)

The room lamp goes on when the switch is turned on with starter switch set to "ON" position.

- ON : The lamp goes on.
- OFF : The lamp goes off.

10 Description of operator's area



(7) Air conditioning heater (depending on model)

Use the various buttons to adjust the air conditioning. (See chapter 11.6 'Operation of the air conditioning heater' for its operation.)

10.3 Control levers and pedals

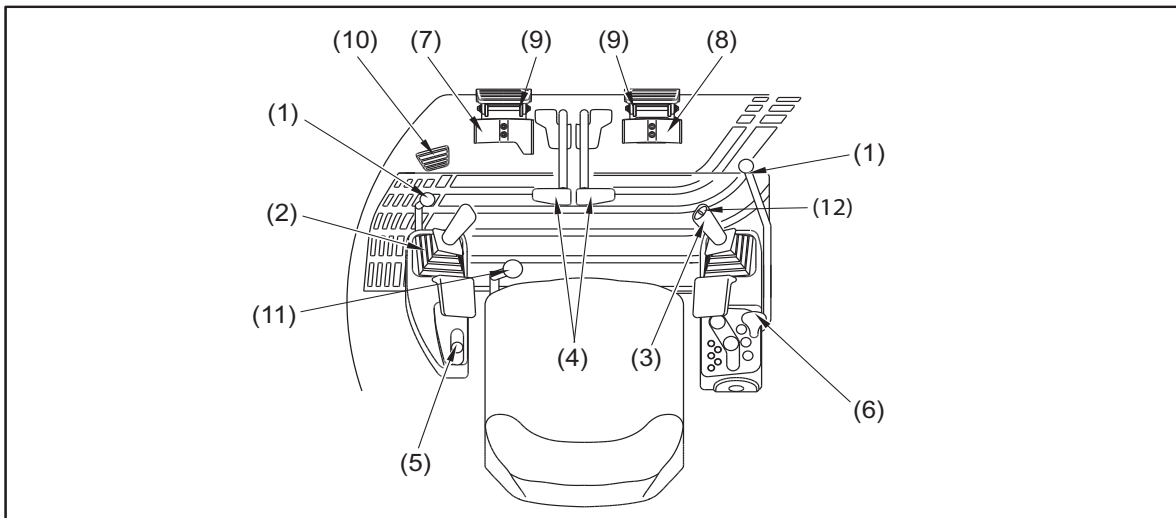

- 1) Lock lever
- 2) Control lever (L)
- 3) Control lever (R)
- 4) Travel levers and pedals
- 5) Accelerator lever
- 6) Blade lever
- 7) 3rd circuit pedal / switch (P.T.O.) (depending on model)
- 8) Boom swing pedal
- 9) Pedal guard (foot rest)
- 10) 2nd speed pedal / switch (depending on model)
- 11) Track spacing levers (for ViO17)
- 12) Proportional P.T.O. (depending on model)

(1) Lock levers (for implement control levers on both sides and travel lever)

The lock levers lock the implement control and travel levers. When pulling the left lock lever back, the control lever stand (L) comes up. While the control lever stand (R) does not come up when pulling the right lock lever back. (Canopy version)

IMPORTANT

The machine uses a hydraulic lock system. If the lock levers are in the lock position, all the hydraulic cylinders for the boom, arm, and bucket as well as the swing and travel motors will not activate although the right and left implement control levers are free to move.

The blade lever is not locked by setting the lock lever to the lock position.

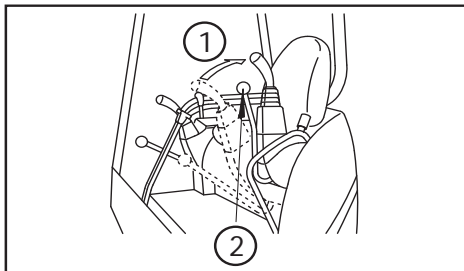

- 1) Locked
- 2) Lock lever (left side)

⚠ CAUTION

The relationship between the control lever shift configuration and the implement movement is detailed in this manual. To prevent an accident due to operational error, therefore, the hydraulic system must not be modified by reconnecting the hydraulic hoses and valves.

(2) and (3) Control levers (left and right)

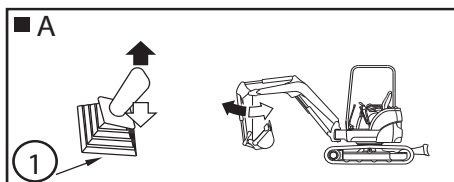

- A = Operating the arm
- 1) Control lever (L)

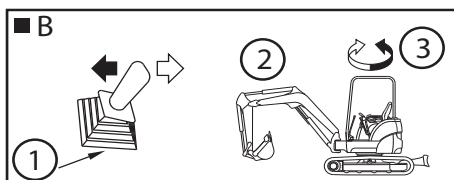

- B = Swing the upperstructure
- 1) Control lever (L)
 - 2) Right swing
 - 3) Left swing

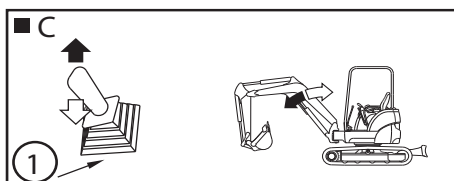

- C = Operating the boom
- 1) Control lever (R)

10 Description of operator's area

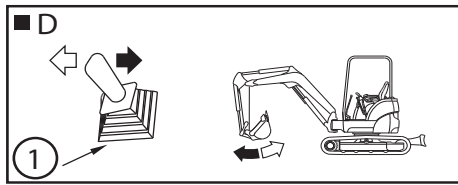

D = Operating the bucket
1) Control lever (R)

(4) Travel levers and pedals

The travel levers control the traveling of the machine.

⚠ CAUTION

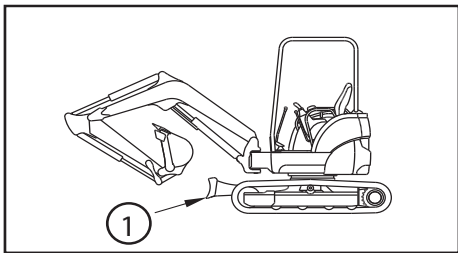

- If the blade is in the reverse direction, the travel levers should also be operated in reverse for forward and backward travel.
- When operating the travel levers, you must check to see if the blade is in the normal position or in the reverse position. Note that the blade is in the normal position when the sprocket is on the rear side.

1) Blade

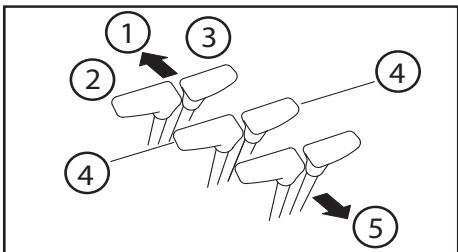

When the blade is in the normal position:
Forward : Push the travel lever forward (1).
(2) left
(3) right
Step on the frontside
Reverse : Pull the travel lever backward (5).
(4) (Neutral) : The machine stops.

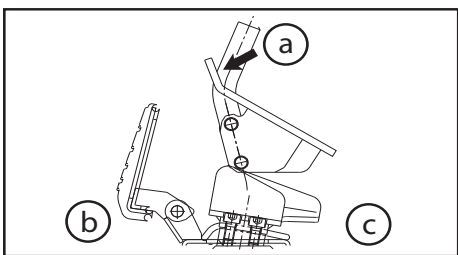

a = Forward
b = Front
c = Rear

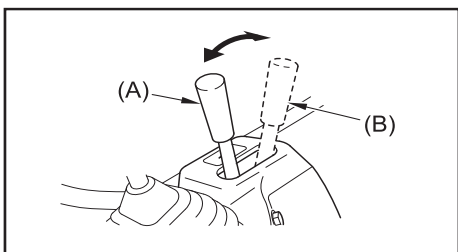

(5) Accelerator lever

The accelerator lever controls the engine speed (output).
(A) Idling : Push the lever forward fully.
(B) Run : Pull the lever backward fully.

10 Description of operator's area

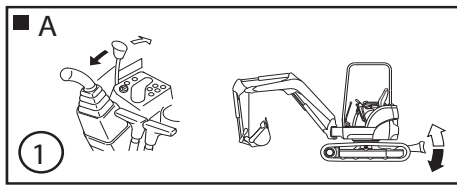

(6) Blade lever

Use this lever to control the blade.

A = Operating the blade

- 1) Blade lever

IMPORTANT

The blade lever is not locked by setting the lock lever to the lock position. Do not touch the blade lever when not operating the blade.

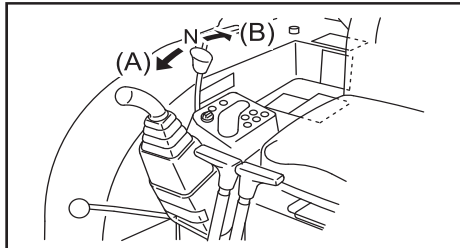

(A) : Down : Push the lever forward.

(B) : Up : Pull the lever backward.

(N) : Neutral...When released, the lever will return to the neutral position and the blade is held as it is.

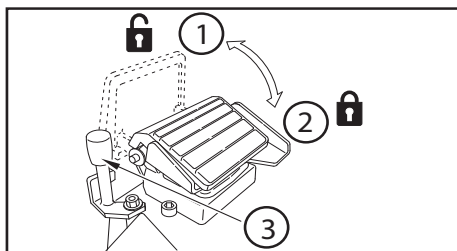

(7) 3rd circuit pedal / switch (P.T.O.) (depending on model)

Use this pedal to control the attachment.

Refer to Section "Handling hydraulic P.T.O.".

- 1) Unlock
- 2) Lock
- 3) P.T.O. pedal lock

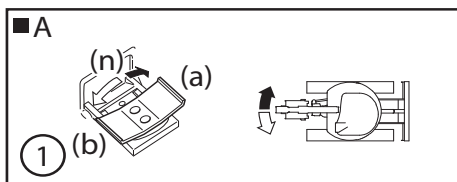

(8) Boom swing pedal

Use this pedal to swing the boom to right and left.

A = Operating the boom swing

- 1) Boom swing pedal

(a) : Swing right : move to the right

(b) : Swing left : move to the left

(n) : Neutral...When released, the pedal will return to the neutral position and the boom is held as it is.

(9) Pedal guard (foot rest)

The boom swing pedal and the P.T.O. pedal have respective pedal guards.

CAUTION

To avoid bodily injury, securely place the pedal guard in the lock position when the boom swing or P.T.O. pedal is not being operated.

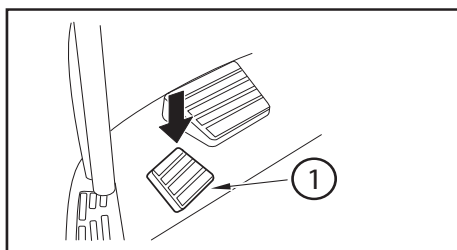

(10) 2nd speed pedal / switch (depending on model)

Step on this pedal to control the travel speed. Step on the pedal while the travel levers are in operation to increase the travel speed.

- 1) 2nd speed pedal

10 Description of operator's area

IMPORTANT

Do not travel at high speed for many hours.

Do not step on the pedal while operating the blade.

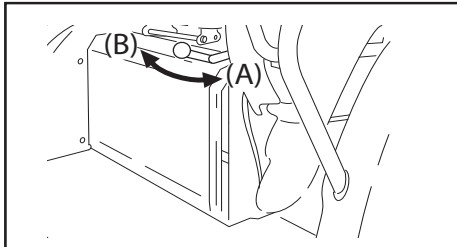

(11) Track spacing lever (for ViO17)

Use this lever to increase or reduce the spacing between the tracks for a proper working position.

- (A) Increase the spacing
- (B) Reduce the spacing

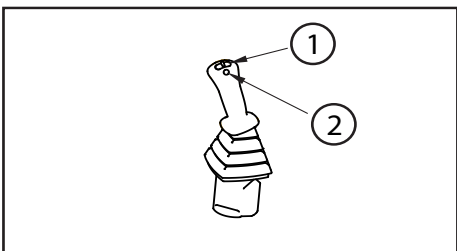

(12) Proportional P.T.O. (depending on model)

Use the proportional roller to adapt the P.T.O. output with double effect.

- 1 = Proportional roller
- 2 = Horn switch

10.4 Storage space for the operation & maintenance manual (depending on model)

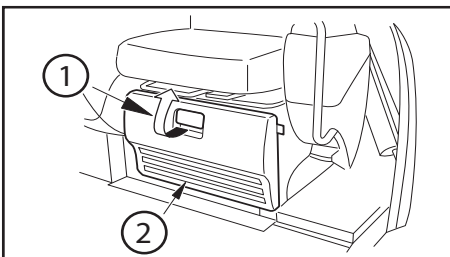

Storage space for the operation and maintenance manual is under the operator's seat (a). (depending on model)

Pull the lever (1) and open the cover (2).

The storage space for the operation and maintenance manual is on the upper side of the compartment.

Press the cover until it clicks when closing.

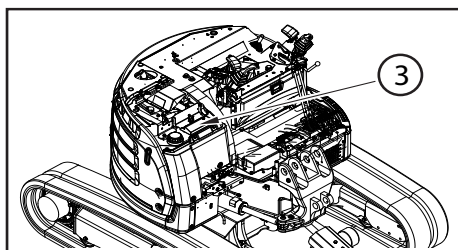
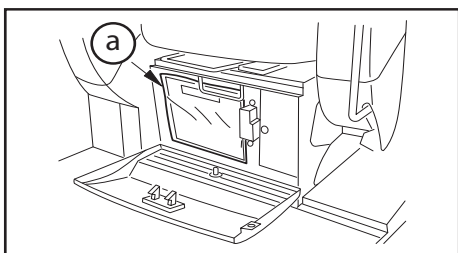

For the ViO50U and the ViO57U, the tool kit is located above the fuel tank. To access it, open the RH side cover.

- 3 = Toolbox

10 Description of operator's area

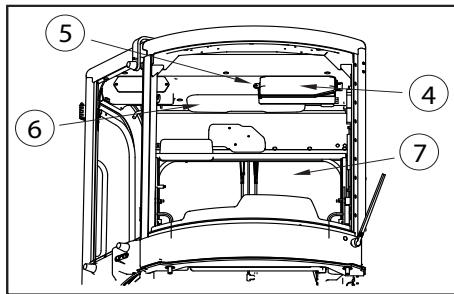

For the ViO50U and the ViO57U, the user's manual is located in the box under the cab roof. Pull the tab to unlock the box and open it. To close it, push the cover until the lock engages.

- 4 = Box for the user's manual
- 5 = Opening tab
- 6 = Sun visor
- 7 = Windscreen

10.5 Operator's seat

⚠ CAUTION

Do not adjust the operator's seat while operating the machine.

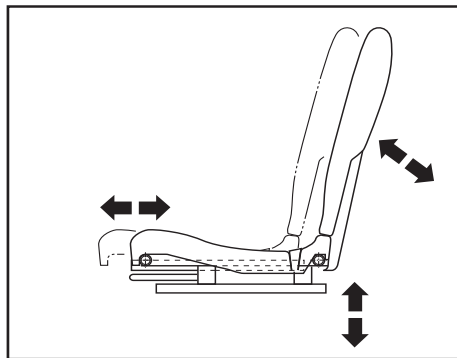

Seat position control adjustment (depending on model)

10.6 Fuses

⚠ CAUTION

- When replacing the fuse, be sure to turn off the power by setting the starter switch at the OFF position.
- Using a wire, aluminum foil or the like instead of the fuse could cause burnouts of the gauges, the electrical equipment and the wiring due to overheating.
- If a new fuse is blown out immediately after replacement, there may be a problem with the electrical system. Ask the nearest dealer for check and service.

The fuse protects the electrical equipment and wiring from becoming overheated. If the fuse is corroded with white deposits or if the fuse is loose in the holder, the fuse must be replaced with a new one.

Position of the fuse box (depending on model)

Fuse box is on the front of sheet mount.

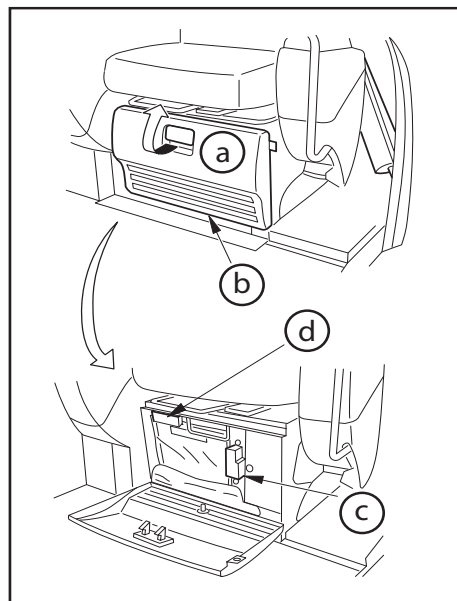

- a = Open
- b = Storage box cover
- c = Fuse box
- d = Fuse box for ViO17

10 Description of operator's area

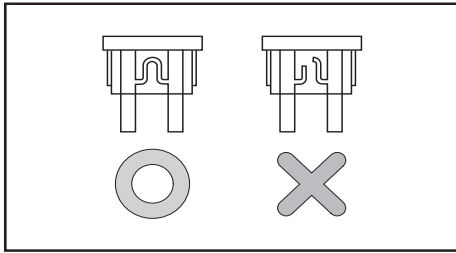

Replacing the fuses

If the electrical equipment does not operate, the fuse may have been blown out. Follow the procedure below:

- 1) Set the starter switch at the "OFF" position.
- 2) Remove the fuse box cover.
- 3) If the fuse is blown out, replace it with a spare fuse of rated capacity.

Machine A = ViO17

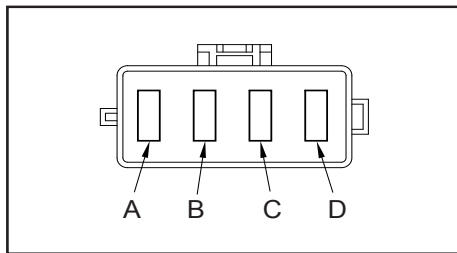

Symbol	Fuse capacity	Circuit name
	Machine A	
A	15 A	Engine shut-off solenoid, current limiter, booster pump solenoid, timer
B	15 A	Boom light, horn, high speed valve
C	15 A	Dashboard, cut-off valve, safety relay
D	15 A	Spare fuses

**Machines B = ViO20-3
ViO25-3
ViO30/35-3**

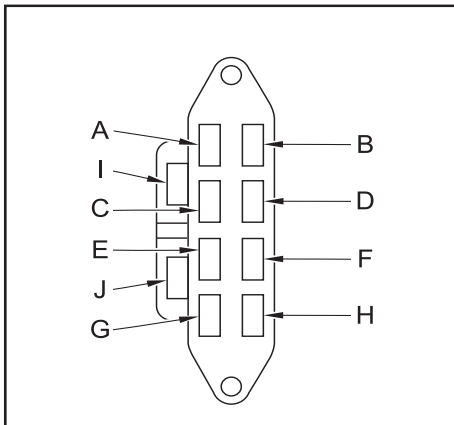

Symbol	Fuse capacity	Circuit name
	Machines B	
A	15 A	Heater, Wind washer
B	30 A	-
C	15 A	Indicator box light, Horn, Boom light, Headlight, High-speed travel valve
D	15 A	Heater relay, Wiper
E	15 A	Timer, Safety relay, Fuel feed pump, Engine stop solenoid, Generator
F	15 A	Indicator box, Cut off valve
G	5 A	Radio
H	5 A	Spare fuse
I	30 A	
J	15 A	

10 Description of operator's area

Machines C = ViO50U
ViO57U

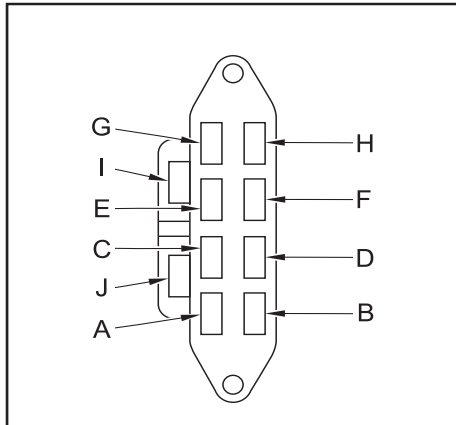

Symbol	Fuse capacity	Circuit name
	Machines C	
A	15 A	Cigarette-lighter, radio, anti-theft device
B	25 A	Diesel reloading pump
C	15 A	Timer, safety relay, alternator, engine shut-off solenoid, engine electrical pump
D	15 A	Seat, relay, PTO pedal switch, reverse alarm, RH/LH joystick, cut-off valve
E	15 A	Spotlight, high speed valve, horn
F	15 A	Windscreen wiper
G	15 A	Cigarette-lighter, quick coupler, heating, air conditioning, safety valve, windscreen wiper motor, windscreen washer
H	30 A	Seat pump, air conditioning
I	30 A	Spare fuses
J	15 A	

10.7 Windshield (for cabin)

⚠ ATTENTION

- To avoid bodily injury while operating the machine, make sure the door and windshield are locked in either the open or shut position.
- When the side door or the windshield are opened and are not securely locked, they may be closed suddenly on impact during operation. They may cause bodily injury : for example, your hands are put between the door or the windshield and the cabin frame or your head is hit against them.
- Do not put your hand or head out of the opened side door or windshield. When opening the side door or the windshield, lock it securely.

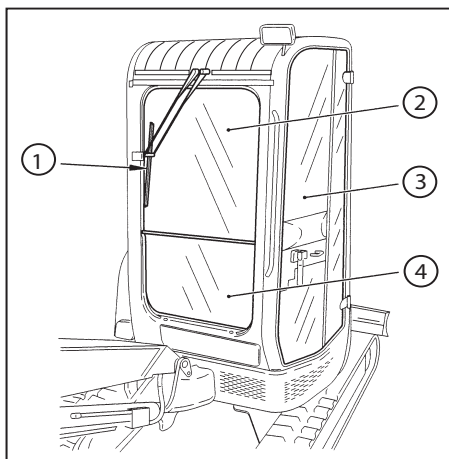

- 1) Wiper
- 2) Upper windshield
- 3) Side door
- 4) Lower windshield

10 Description of operator's area

⚠ CAUTION

Both the upper and lower windshields can be opened and closed.

When opening or closing the upper and / or lower windshields, they may go down suddenly. To prevent this, lock them securely with the lock levers.

⚠ CAUTION

- To avoid bodily injury, securely grasp the handles with both hands when opening and closing the windshield.
- Securely lock the windshield using the lock levers and the window locks when storing or closing the upper and lower front windshields.
- When opening or closing the front windshield, be sure to place the lock levers securely in the lock position.

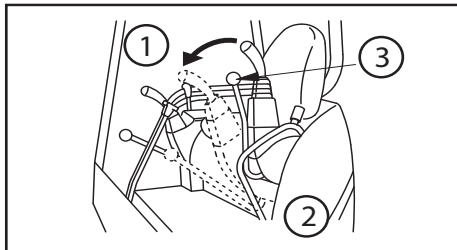

- 1) Unlock
- 2) Left side
- 3) Lock lever

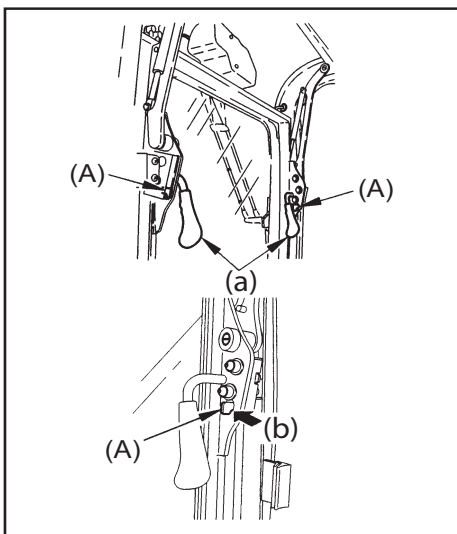

Opening the upper windshield (depending on model)

- 1) Hold the handles with your hands and push the right and left lock levers (A) to the arrowed direction to release the lock.
- 2) Slide the windshield to the upper rear side while pulling it to this side.
- 3) Slide the front windshield to the storage position under the ceiling and push it up until it is securely locked with a click.

a = Handle
b = Push

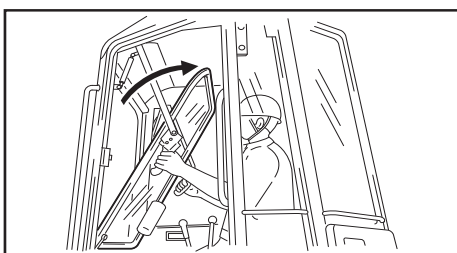

Closing the upper windshield (depending on model)

- 1) Hold the handles with your hands and release the right and left lock levers (A).
- 2) Slowly lower the front windshield by grasping the handles.
- 3) Push the front windshield forward until it is locked with a click.

10 Description of operator's area

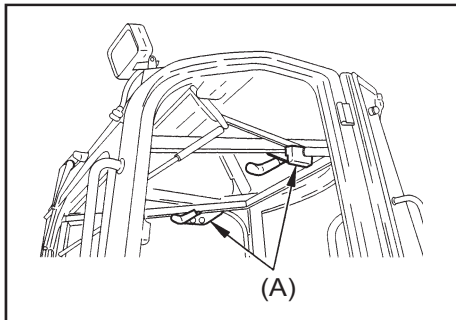

Opening and closing the lower windshield (depending on model)

⚠ ATTENTION

Open and close the lower windshield after housing the upper windshield.

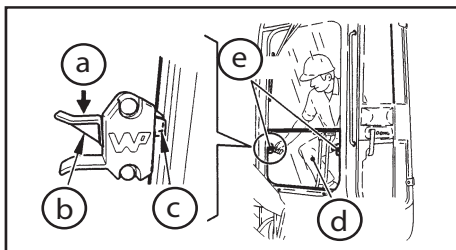

- a = Push
- b = Lever
- c = Lock position
- d = Lower windshield
- e = Lever

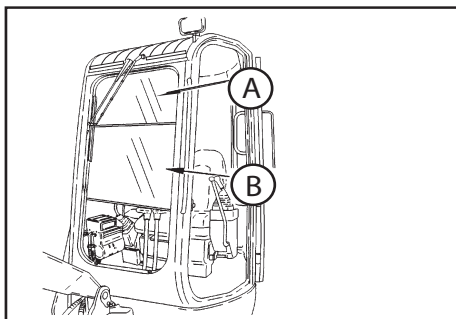

- 1) Hold the lower windshield with both hands to lift it up.
- 2) Put the lower windshield in the storage area on the rear left of the cabin.
- 3) Lock the lower windshield securely by pressing it against the window locks.
- 4) Push the upper side of each window lock to remove the windshield put in storage.

- A = Upper windshield
- B = Lower windshield

10.8 Air outlet (for cabin)

The wind direction is adjusted by changing the grille direction.

Move the grille to the desired position with a knob in the center of the grille.

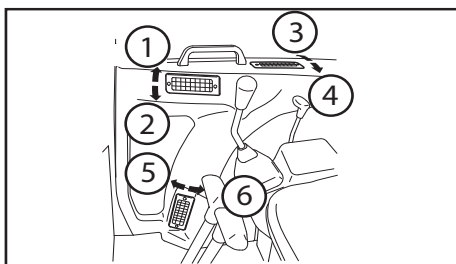

- 1) Up and open
- 2) Down and close
- 3) Outward side and open
- 4) Inward and close
- 5) Outward and open
- 6) Inward and close

10 Description of operator's area

10.9 Ash tray (for cabin)

CAUTION

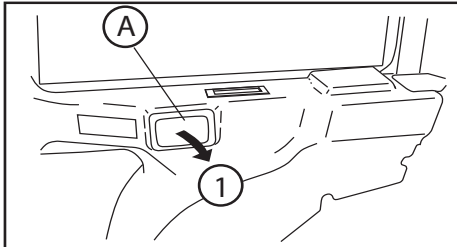

Do not place any combustible matter in the ash tray.

Open the ash tray by pulling the lid (1) to use it. Be sure to close the ash tray lid when it is not in use.

When cleaning the ash tray, remove it by pressing down and pulling it toward you. To install the ash tray, press it into place, keeping it level.

A = Ash tray

10.10 Right window glass (for cabin)

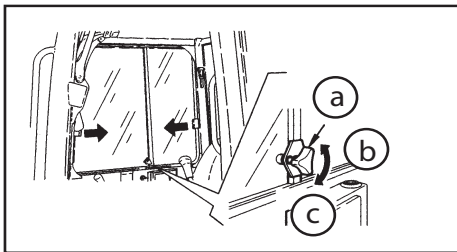

1) Open the window by sliding the glass on each side in the direction indicated in the figure at the right.

2) Tighten the slide stopper to fasten the glass at that position.

3) When closing the window, loosen the slide stopper.

a = Slide stopper

b = Loosen

c = Tighten

10.11 Cabin side door

Opening and closing the cabin side door

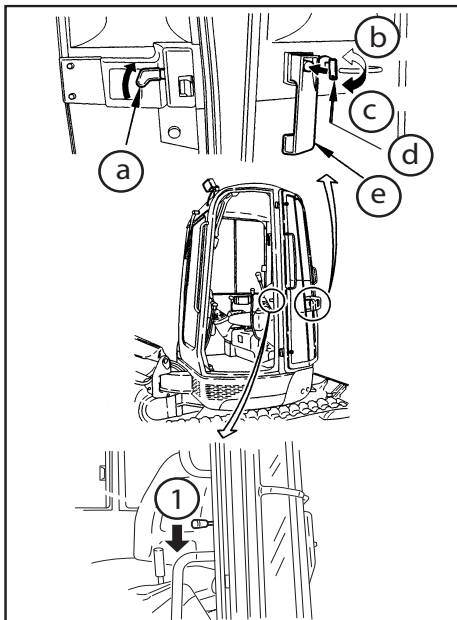

(1) From outside.

4) Turn the starter switch key counterclockwise to unlock the side door.

5) Push the button of the outer handle and pull the outer handle to open the side door.

6) Close the side door and turn the key clockwise to lock the door.

(2) From the inside.

1) Pull the inner handle to open the side door.

a = Inner handle

b = Unlock

c = Lock

d = Key

e = Outer handle

Door lock

The door lock is used to hold the side door open.

- 1) Press the side door into the lock section to hold it open.
- 2) Press the lever (1) on the left side of the seat down to release the locked side door.

10.12 Replenishment of windshield washer fluid (for cabin)

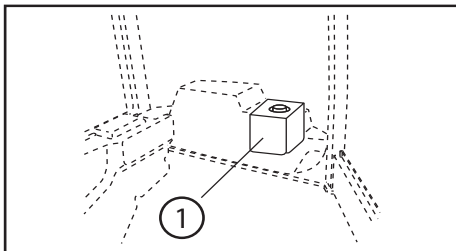

- 3) Add windshield washer fluid, if necessary, to the reservoir (1). (location depending on model)

ATTENTION

- When you add the reservoir with windshield washer fluid, take care not to enter dust into the reservoir.
- Determine the mixing ratio of the windshield washer fluid to water on the basis of the lowest past temperature

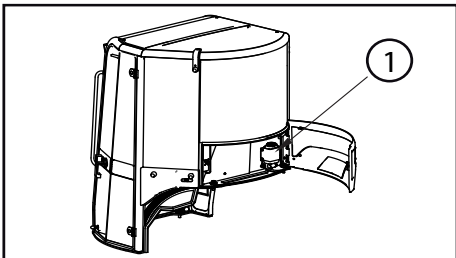

11 Instructions

11.1 Break in period

The machine should not be subjected to severe stresses and loads during the initial break in period although it has been prepared well and stringently inspected before shipping. Otherwise the machine's performance may be affected and its service life shortened. Thus it is essential to break in the machine for the first approx. 100 service hours (reading of the hourmeter).

In breaking in the machine:

- You should warm up the engine by idling for 5 minutes before starting operations.
- You should not operate the machine under heavy loads or at high speed.
- You should not start and accelerate the engine too abruptly, or stop it too abruptly.
- You should not change travel direction too abruptly.

The safety instructions for operation and maintenance that are presented in this Manual are applicable to each of the intended tasks. Never misuse this machine by violating the applicable safety instructions or by attempting to perform unintended tasks, because of the danger of serious bodily injury.

11.2 Checking before starting the engine

Walking check (visual inspection) around the machine

CAUTION

- If there are any combustibles in any heat build-up areas, or if there are any fuel and/or oil leaks, a fire can result.
 - Check for possible fire causes carefully. If there is anything abnormal, be sure to take corrective action or contact your dealer.
- 1) Checking the implement, hydraulic cylinders, linkages, and hoses for damage, wear and loose connections.
 - 2) Removing dust deposits from around the engine, battery, and radiator.
 - 3) Checking the engine and its accessories for oil or water leakage.

- 4) Checking the hydraulic system, hydraulic oil tank, hoses, and joints for oil leakage.
- 5) Checking the grease piping for grease leakage.
- 6) Checking the undercarriage (crawler, sprockets, and idlers) for breakage, wear, loose bolts, and oil leakage around the rollers.
- 7) Checking the handrails and steps for breakage and loose bolts.
- 8) Checking the water separator to see whether the red ring has sunk down at the cup bottom.

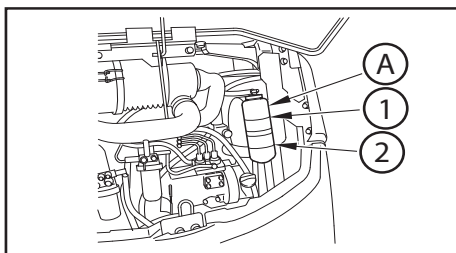

Checking and replenishing the cooling water

A = Sub-tank

- 1) Maxi.
- 2) Mini.

CAUTION

- Normally do not open the radiator cap.
- Check the cooling water in the sub-tank when the engine is cool.

Checking and replenishing the engine oil

CAUTION

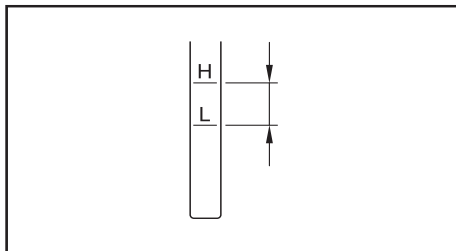

- At operating temperature, the oil and dipstick areas are hot.
- Do not allow hot oil or components to contact the skin to prevent bodily injury such as a burn.
- Check oil level and refill oil after engine has cooled down sufficiently.

Checking the fuel level in the fuel tank and refueling

CAUTION

Be careful not to overfill the fuel tank because it could cause a fire. If the tank is overfilled, completely wipe off the spilled fuel.

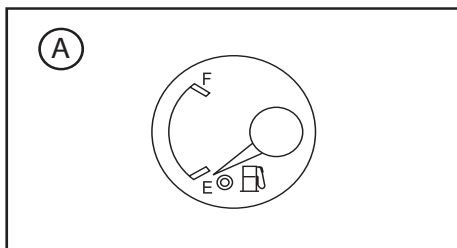

A = Fuel
F = Full
E = Empty

11 Instructions

Checking and replenishing the hydraulic oil tank

CAUTION

When removing the plug of the oil supply port, slowly loosen it to release the pressure in the tank to prevent a dangerous high-pressure leak.

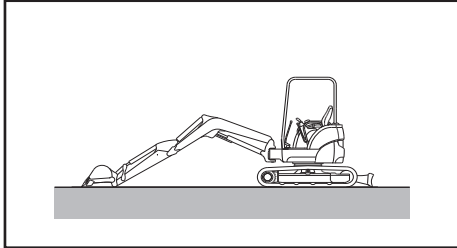

IMPORTANT

Do not replenish hydraulic oil above the upper limit mark on the oil level gauge. An excessive amount of hydraulic oil may damage the hydraulic system by placing stress on its components, causing a dangerous high-pressure leak.

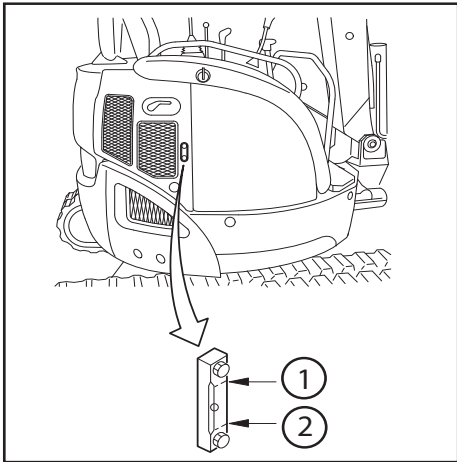

Note:

Note that the oil level varies with the oil temperature. When reading the oil level, follow these guidelines:

- Before start-up, the oil level gauge should read the level around the midpoint of the gauge scale [oil temperature : 50 to 86°F (10 to 30°C)].
- During normal operation, the oil level gauge should read the level around the upper limit mark of the gauge scale [oil temperature : 122 to 176°F (50 to 80°C)].

- 1) Upper limit
- 2) Lower limit

Checking the greasing points (depending on model)

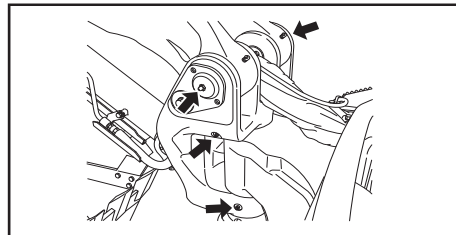
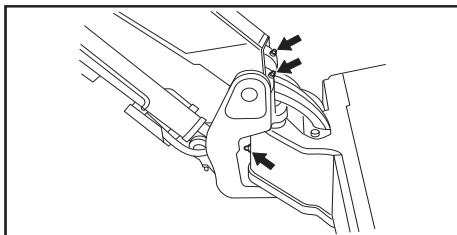
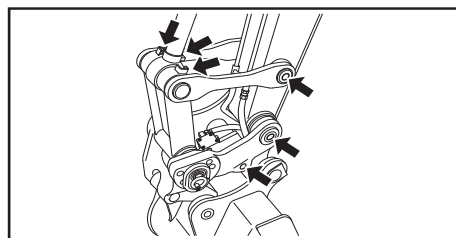
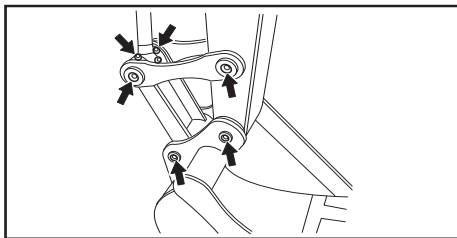

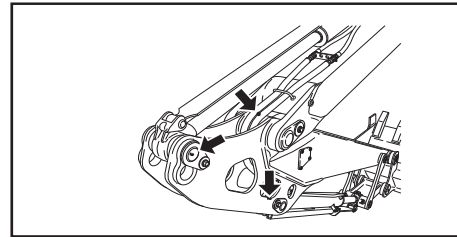
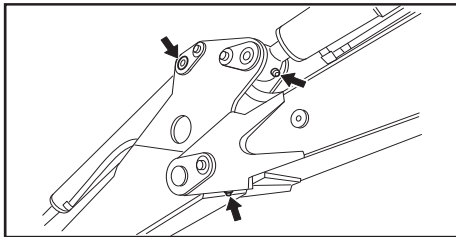
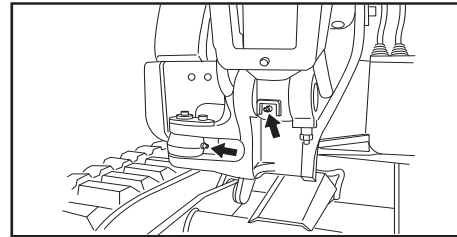
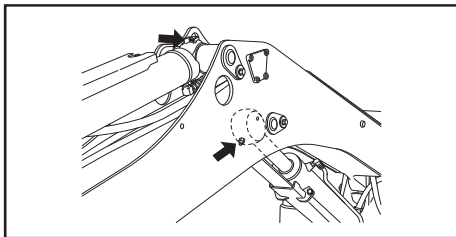
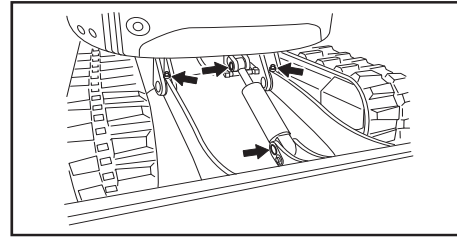
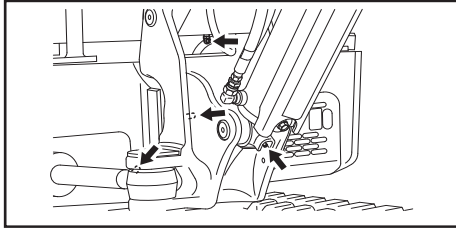

11.3 Precautions for operating the implement

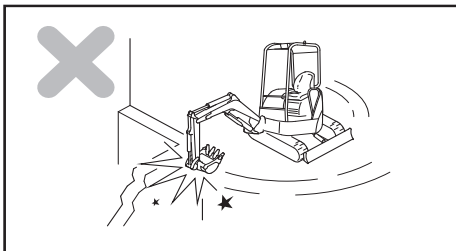

Do not use the implement's swing force

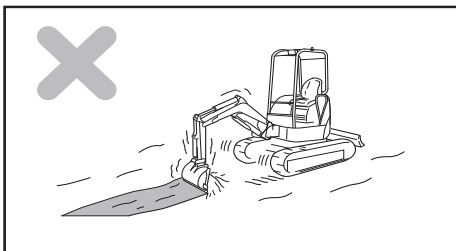

Do not use the implement's travel force

11 Instructions

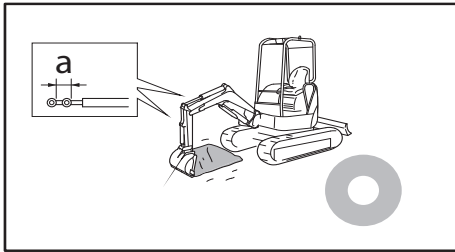

Take care not to operate the hydraulic cylinder to the stroke end

a = Margin

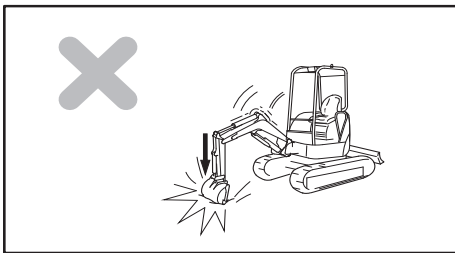

Do not operate the implement by the using the dropping force of the bucket

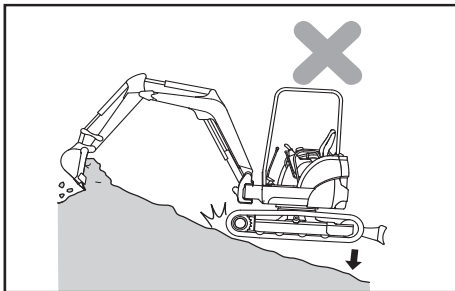

Do not operate the implement by using the dropping force of the machine

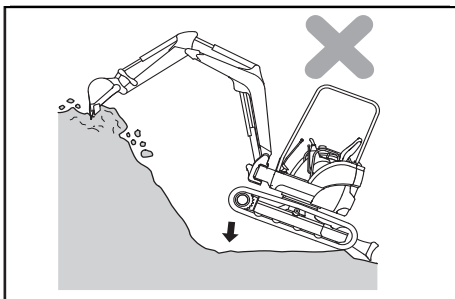

Excavating a hard rock

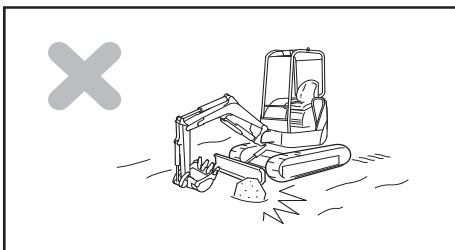

Do not bump the blade against a large rock or boulder

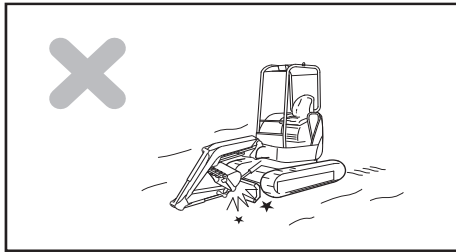

Be careful when retracting the implement

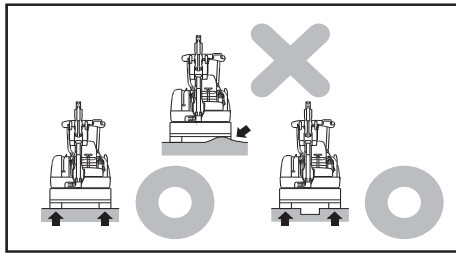

Support the blade on both sides

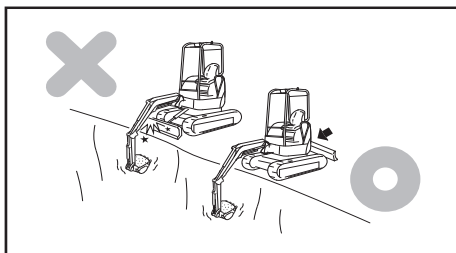

Be careful not to bump the blade when excavating

11.4 Handling the rubber crawler

Using the rubber crawler properly

The rubber crawler has some advantages over the steel crawler.

However, you cannot take full advantage of it if you use it in the same manner as for the steel one. Take care in operating with the rubber crawler according to the conditions of the work site and the type of work.

Comparison Table of Rubber and Steel Crawlers

	Rubber	Steel
Low vibration	◇	□
Smooth travel (with no creak)	◇	○
Silent travel	◇	□
Less damage to paved roads	◇	□
Simple handling	◇	□
Susceptibility to damage (strength)	□	◇
Tractive force	◇	◇

◇ : Excellent

○ : Good

□ : Ordinary

11 Instructions

Rubber crawler has many advantages inherent in the unique properties of the material. On the other hand, however, it is low in strength. It is essential that you fully understand the properties of rubber crawler, and observe the precautions for operating and handling it to prolong its life and get the most out of it.

11.5 Handling hydraulic P.T.O.

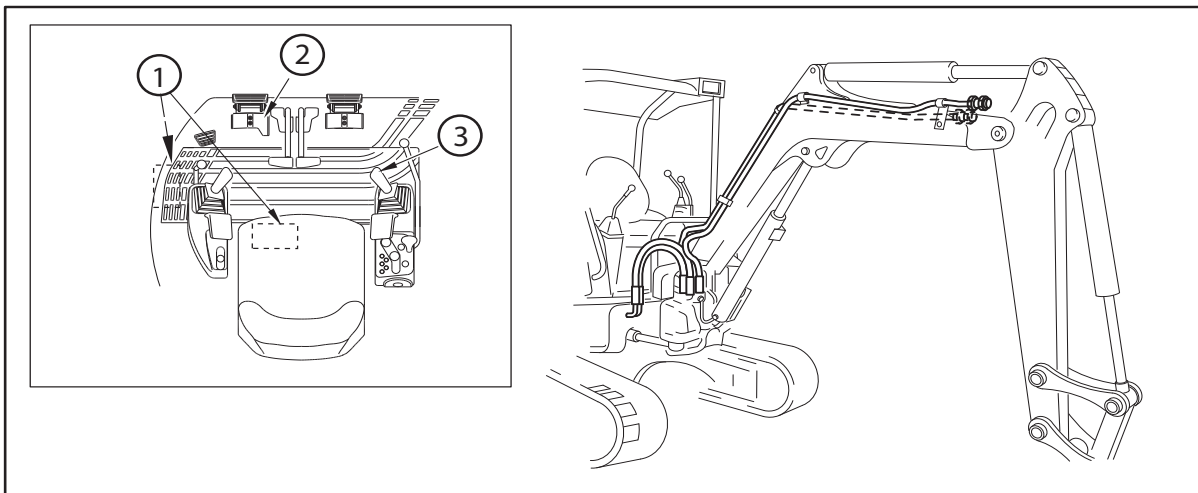

- 1) P.T.O. selector valve
- 2) P.T.O. pedal
- 3) P.T.O. -switch (depending on model)

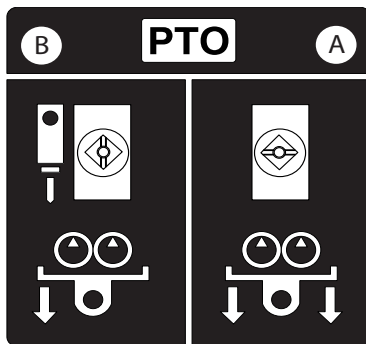

(1) P.T.O. selector valve (depending on model)

Use this valve (1) to select the P.T.O. in single acting or double acting mode.

A = Double acting P.T.O.

B = Single acting P.T.O. with direct flow to the tank

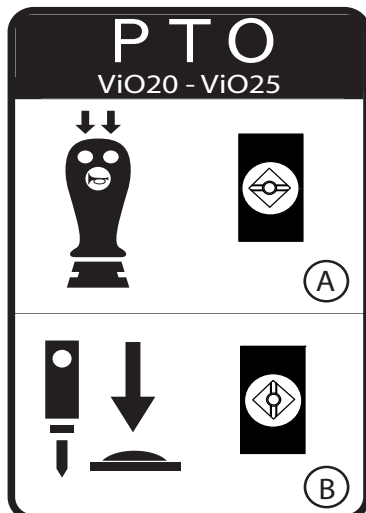

CAUTION

When changing the hydraulic piping connection, stop the engine and slowly loosen the connection to release the inner pressure.

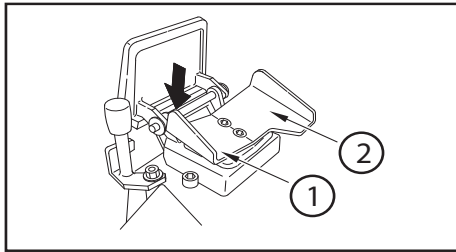

(2) P.T.O. pedal (depending on model)

- Use this pedal to operate the attachment.
- Move the P.T.O. pedal to the left side (1) for operating the single acting actuator type of attachments, when the P.T.O. selector valve is in the single acting position.
[Example of the P.T.O. : Breaker]

- 1) Left
- 2) Right

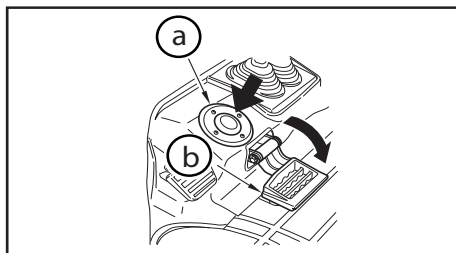

- a = P.T.O. foot switch (single acting)
b = Foot rest

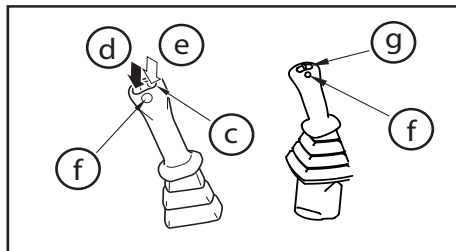

(3) P.T.O. -switch (depending on model)

Use this switch for single or double acting, according to the P.T.O. selector valve position.

- c = P.T.O. -switch
d = single effect
e = double effect
f = Horn-switch
g = Proportional roller (depending on model)

IMPORTANT

Before disconnecting the attachments, shutdown the machine, leave the key in the "ON" position and press the pedal of the 3rd circuit to release the residual pressure.

11.6 Operation of the air conditioning heater (depending on model)

The control panel is installed on the machine dashboard.



11 Instructions

Advice for using the air conditioning

- The air conditioning operates when the temperatures inside the cab are above 18°C, the vehicle engine is running and the inside blower is working.
- When air conditioning is working, it is advised to fully close the windows.
- The air conditioning removes the humidity from the cool air blown into the operator compartment (condensation) and it can therefore be seen a small pool of water when the machine is parked. This is normal.
- In hot weather, when you enter the vehicle, it is recommended to open the windows for a few minutes to remove the hot air from the operator compartment. This will improve the air conditioning performance.

System operation:

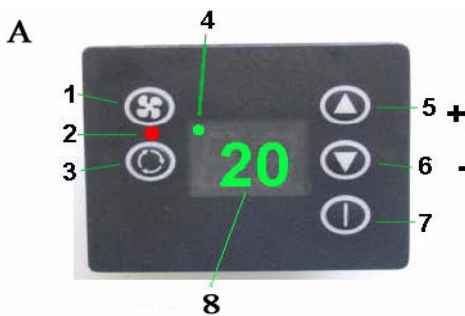

- A = Control panel
- 1 = Ventilation speed
 - 2 = Red light = Door closed
 - 3 = Recycling door control
 - 4 = Green light
 - 5 = Temperature (increase)
 - 6 = Temperature (decrease)
 - 7 = On/Off
 - 8 = Display of the required temperature

Installed on the vehicle dashboard, the control panel contains the main processor and comprises a keypad for operational programming of the air conditioning system, as well as a digital screen to display parameters, operating statuses, fan speed and temperature.

On/Off

- Once energised with 12V, the regulator display indicates for a few seconds the soft version, then a green LED (4) flashes on the top LH corner of the display (the self-test is completed).
- To switch on the screen, press (7) (On/Off) and it will display the set point. The luminous point (2) located on the side of the screen will indicate whether recycling is active (ref. system parameters).
- To switch off the control panel, just press (7) (On/Off).

Digital screen

- The screen normally displays the temperature set point. It is also used to give the alert when a breakdown occurs in the system and display the system parameters.

Temperature sensor

- When the system is on, the temperature set point is displayed by default. However, by keeping the On/Off button depressed for three seconds, it is possible to display the temperature inside the cab. This change in display is indicated by the decimal point flashing. After a while, the display will indicate again the set point value and the decimal point will stop flashing.

Set point

- The set point is the temperature required inside the vehicle. To set it, press (5) (+) or (6) (-) and the set point value will flash on the screen. Press again one of these keys until obtaining the temperature required. Depending on the temperature difference between the set point and that provided by the probe, the regulator transmits the information required to operate the air conditioning or the heater.

Ventilation

- The ventilation function will operate even if the refrigeration function is not operating. The display has a 3-speed ventilation option: U1 (slow speed), U2 (average speed) and U3 (high speed). The system will always start in the AU position, which means an automatic speed adjustment, that speed being controlled according to the set point value. To modify the speed, activate the ventilation function by pressing (1) (Ventilation) before determining the required speed using keys (5) (+) and (6) (-).

Air recycling

- The air renewal door is manually controlled. To modify its status, press (3). When the luminous point is on, the air renewal is active, which corresponds to opening the outside air door. When the indicator diode is off, the air renewal is de-activated. When the appliance is switched off then on again, the last recycling door status will be restored.

Faults

- The appliance may indicate two faults:

OP' probe switched off,

'SC' probe shorted.

Diffusion of the air in the cab

The evaporator heater assembly is integrated inside the cab, below the RH side of the dashboard.



1 = Air diffusers built into the dashboard

2 = Evaporator heater assembly and protection casings

11 Instructions

11.7 Using the refuelling electrical pump (depending on model)

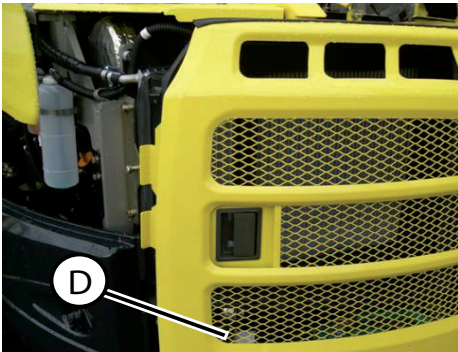

Position of the refuelling electrical pump (D). .

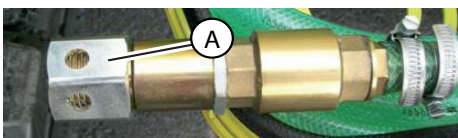

1) Unscrew the suction strainer plug (A).



2) Open plug (B) on the diesel tank.

3) Dip the suction strainer in the volume of diesel to be sucked.



4) Start the pump by pressing the on/off button (C).

*Remark:
The tank is equipped with a level sensor (automatic pump shut-off).*



5) Stow away the whole assembly.

- Close the strainer plug (A).
- Close the tank plug (B).
- Stow away the suction pipe in its compartment.



12 Transportation

12.1 Precautions for transporting the machine

Shipping weight: Refer to the specifications table.

CAUTION

- **Select a route for transporting the machine based on the road width and clearance, and the height and weight of the machine.**

For safer transportation, comply with all local regulations and laws.

12.2 Machine tie-down

CAUTION

- **Do not tie the machine down with a person on or on an attachment.**
- **Use a chain sufficiently resistant for the machine weight.**
- **Do not tie the machine down to other points than those indicated below:**
- Machine attachments and equipment items that are not secured with limiting devices and may move beyond the vehicle envelope should be prevented from moving. Instructions should be provided on the equipment item limiting the tie-down device movement.
- It is advised to correctly secure on the trailer floor loose parts such as hydraulic cylinders that can move due to vibrations during transport and/or limit their displacement using a tie-down device.
- **Precautions concerning side movements:**
- The machine should be tied down using the securing devices provided for the vehicle, using appropriate tie-down attachments or using devices appropriate for the machine, e.g. by tying down the machine chassis using metallic cables or chains.

12.3 Machine slinging

CAUTION

- Never suspend the machine if any person is on the machine or the implement.
- Use wire ropes strong enough for the weight of the machine.
- Do not suspend the machine in any way other than that explained on the following page.
- Failure to suspend the machine as prescribed will throw the machine off balance.
- Do not swing the machine being suspended.
- When lifting the machine, keep the machine in balance taking care on the center of gravity of the machine.
- Never stand near or under the suspended machine.

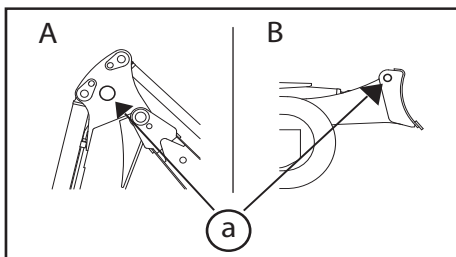

For safety in suspending the machine, comply with all applicable regulations.

Suspend the machine on the level ground as follows:

A = Front side
B = Rear side

a = Hook bores are on both ends.

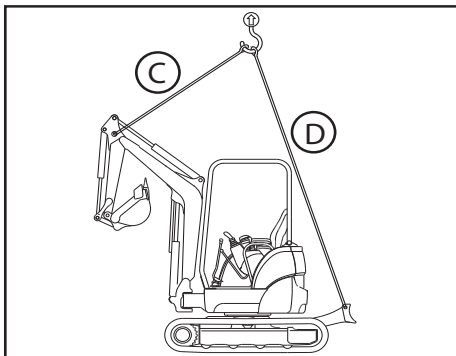

- 1) Swing the upperstructure so that the blade is behind the operator's seat.
- 2) Raise the blade to the highest limit.
- 3) Extend the hydraulic cylinders of the front implement (except for the swing cylinder) to the maximum.
- 4) top the engine, and make sure that nothing is left around the operator's seat before leaving the machine.
- 5) Fit the shackles to the suspending hooks on the front side (one point) and the rear side (two points), and securely fasten a sling belt (or a wire rope) to the shackles.

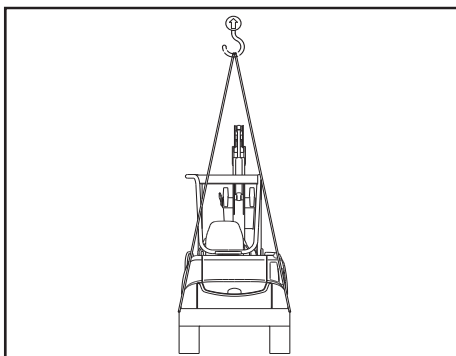



12 Transportation

	ViO17	ViO20-3	ViO25-3
C	2,0 m	1,5 m	1,5 m
D	4 m x2	3,4 m x 2	3,4 m x 2

	ViO30-3	ViO35-3	ViO50U	ViO57U
C	1,5 m	1,5 m	2,0 m	2,0 m
D	3,4 m x 2	3,4 m x 2	5,0 m x 2	5,0 m x 2

13 Long-term Storage

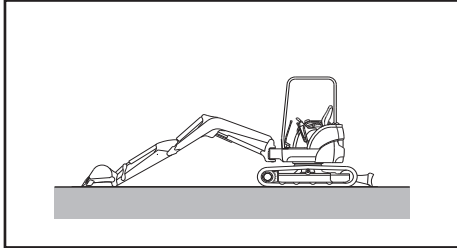

IMPORTANT

When storing the machine, set up the machine as illustrated in the left figure to protect the hydraulic cylinder rods from being corroded.

- Apply lube oil and grease to the machine and replace the engine oil.
- Apply a little amount of antirust to exposed parts of the hydraulic cylinder rods.
- Add an anti-freeze to the cooling water if the air temperature can fall below 0°C.
- To prevent condensation inside the fuel tank, either drain off the fuel tank or fill the tank.

Move the machine at least once a month to form new oil films on all the moving parts during long-term storage, and recharge the battery at the same time.

Note:

Store the machine in accordance with the ISO 6749/1984 Standard.

14 Troubleshooting

14.1 Phenomena that are not breakdowns

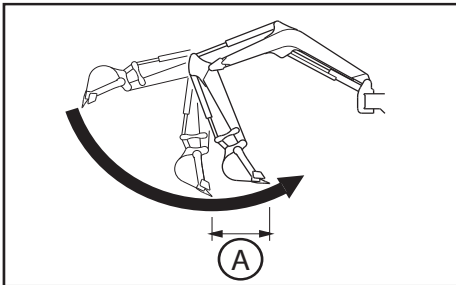
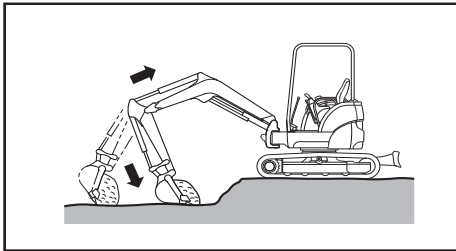

The following phenomena are not breakdowns:

- Shaking of the bucket.
When the boom is raised immediately after extending the arm while curling the bucket, the bucket may shake. This phenomenon is not a breakdown.
- Discontinuous arm movement.
When digging the ground with the arm, the arm may slow down at the almost vertical position momentarily. This phenomenon is not a breakdown. Especially, this phenomenon will occur when the engine speed is low.

A = Slow-down is remarkable over this range.

- Shift in upperstructure position.
When turning the machine sharply such as spin-turning or pivot-turning, the upperstructure may be slightly shifted. This phenomenon is not a breakdown.
- Thermal shock of the travel motor.
If, in cold weather, the temperature of the hydraulic oil is raised 60°C higher than the outside temperature by relief operation without traveling after the engine has started, sometimes the machine cannot pivot-turn because of thermal shock. This phenomenon is not a breakdown.
- The swing cylinder is extended when digging.
The swing cylinder may be extended in some digging situations or postures. This phenomenon is not a breakdown.
- Time lag in travel speed change response.
At low engine speed, a time lag in response may occur when the travel speed is changed from high-speed to low-speed. This phenomenon is not a breakdown.



14 Troubleshooting

14.2 Troubleshooting

Engine

- Contact your dealer about the measures shown in parentheses in the list below.
- If there is any abnormality or trouble whose cause is unknown other than those shown below, ask your dealer for repair.

Problem		Cause	Measure
Engine	Steam comes out of top of radiator.	<ul style="list-style-type: none"> • Shortage of cooling water 	<ul style="list-style-type: none"> • Check cooling water level. Refill, if necessary. (Check cooling water for leak from water port.) • Adjust belt tension. • Replace cooling water. Clean inside of cooling water system. • Replace thermostat. • Clean or repair fin.
	Water temp alarm lamp lights.		
	Turning on starter motor does not start engine.	<ul style="list-style-type: none"> • Shortage of fuel • Air mixed in fuel system • Defective fuel injection pump or deteriorated nozzle performance • Improper compression • Blown out fusible link • Damaged key stop solenoid. Link disengagement 	<ul style="list-style-type: none"> • Refill fuel tank. • Repair air leak. Release air from fuel system. • (Replace pump or nozzle.) • (Check and repair.) • Replace fusible link. • (Check and repair.)
	Dark fumes come out of machine.	<ul style="list-style-type: none"> • Clogged air cleaner element • Deteriorated nozzle performance • Improper compression 	<ul style="list-style-type: none"> • Clean or repair element. • (Check and repair.) • (Check and repair.)
Exhaust color is white or bluish white.	<ul style="list-style-type: none"> • Too much oil in oil pan • Improper fuel • Worn cylinder or piston ring 	<ul style="list-style-type: none"> • Drain oil from oil pan to specified level. • Replace fuel with recommended one. • (Repair.) 	



Electrical equipment

- Contact your dealer about the measures shown in parentheses in the list below.
- If there is any abnormality or trouble whose cause is unknown other than those shown below, ask your dealer for repair.

Problem		Cause	Measure
Electrical equipment	Turning starter switch to "START" does not start starter motor.	<ul style="list-style-type: none"> • Defective wiring system • Defective starter switch • Insufficiently charged battery • Defective starter motor 	<ul style="list-style-type: none"> • Check and repair wiring system. • Replace starter switch. • Recharge battery. • (Check and repair.)
	Maximum engine speed does not provide enough brightness of lamps.	<ul style="list-style-type: none"> • Defective wiring system • Defective generator or regulator 	<ul style="list-style-type: none"> • Check terminals for looseness and disconnection. Repair terminal, if necessary. • (Check and repair.)
	During engine operation, lamp is extremely bright, and frequently burns out.	<ul style="list-style-type: none"> • Defective regulator 	<ul style="list-style-type: none"> • Replace regulator.
	Electrolyte leaks from battery.		
	Speed of starter motor is too low.	<ul style="list-style-type: none"> • Defective wiring system • Insufficiently charged battery • Defective starter motor 	<ul style="list-style-type: none"> • Check and repair wiring system. • Recharge battery. • (Check and repair.)



14 Troubleshooting

Machine body

- Contact your dealer about the measures shown in parentheses in the list below.
- If there is any abnormality or trouble whose cause is unknown other than those shown below, ask your dealer for repair.

Problem		Cause	Measure
Machine body	Power or speed of moving part is low.	<ul style="list-style-type: none"> • Deteriorated function caused by worn hydraulic pump • Pressures of main relief valve, or port relief valve of control valve are dropped below set value. • Damaged hydraulic cylinder • Insufficient amount of hydraulic oil • Clogged filter 	<ul style="list-style-type: none"> • (Replace hydraulic pump.) • (Check and repair valves.) • (Check and repair.) • Replenish hydraulic oil up to specified level. • Clean or replace filter.
	Upperstructure does not swing or does not swing smoothly.	<ul style="list-style-type: none"> • Swing brake is not released • Insufficient amount of grease • Defective swing brake valve • Defective swing motor 	<ul style="list-style-type: none"> • (Check and repair.) • Check and grease. • (Check and repair.) • (Check and repair.)
	Temperature of hydraulic oil is too high.	<ul style="list-style-type: none"> • Insufficient amount of hydraulic oil • Overload 	<ul style="list-style-type: none"> • Replenish hydraulic oil up to specified level. • Lower load.
	Machine does not move straight.	<ul style="list-style-type: none"> • Improperly adjusted crawler or trapped foreign material • Damaged hydraulic motor. • Defective hydraulic pump • Defective control valve • Damaged sprocket, idler or track roller. 	<ul style="list-style-type: none"> • Adjust or clean. • (Check and repair.) • (Check and repair.) • (Check and repair.) • (Check and repair.)



MAINTENANCE





15 Precautions for Servicing

Do not use any inspection or servicing procedures that are not described and recommended in this manual.

Park the machine on solid, level ground to inspect and service it.

Attach the warning tag

When the oil or the cooling water is drained, attach the "SERVICING IN PROGRESS" tag to the operator's seat so that other persons will not start the engine.

Observe the precautions for welding

- Make sure to disconnect the battery cables (positive and negative terminals).
- Do not apply more than 200 V continuously.
- Ground the machine within 1 m from the welded part.
- Make sure that there is no seal or bearing between the welded part and the grounded part.
- Do not ground around the pins on the implement or the hydraulic cylinder.

Observe the precautions for cleaning the machine

- Do not spray steam directly at the connectors.
- Do not splash water on the monitors in the cabin.
- Do not spray high-pressure water directly at the radiator and the oil cooler.

Do not mix oils

Never mix oils of different makes or types. If you have to replenish an oil with a different make or type than the one already in the tank, remove the remaining oil completely.



16 Basic Servicing Practices

16.1 Filter

The filters are very important parts which prevent impurities from getting into critical devices through the lube oil, fuel and air systems. Replace the filter elements periodically according to the instructions of the Operation Manual. Under difficult conditions, you need to replace the filter elements earlier than suggested in the Operation Manual depending on the type of oil and fuel (sulfur content).

- Never reuse the filter elements (cartridge type) by cleaning them.
- When replacing an oil filter element, check that no metallic dust or foreign solids are present on the old filter.
- If they are found to be present, contact the nearest dealer.
- Do not unpack the filter element before use.
- Use AMMANN YANMAR genuine filter elements.



17 Fueling, Oiling and Greasing Based on Temperature Range

17 Fueling, Oiling and Greasing Based on Temperature Range

17.1 Fuel and oil

Select fuel and oil based on the temperature range. If you start the engine at air temperatures lower than 32°F (0°C), use SAE10W, SAE10W-30, or SAE15W-40 even if the temperature in the daytime rises to 50°F (10°C) or so. Machines can operate using B-type BIO diesel.

17.2 Cooling water

Because a AMMANN YANMAR genuine long-life coolant (LLC) is added to the cooling water, you need not change it unless the temperature falls below -31°F (-35°C).

Components	Fluid	Recommendations with regard to temperature ranges						Prescribed amount (litre)				
		(°F)	-4	14	32	50	68	86	ViO17	ViO20-3	ViO25-3	
		(°C)	(-20)	(-10)	(0)	(10)	(20)	(30)				
Engine	Engine oil	SAE 10WCD						2,8 +0,4	3,5 + 0,4	3,5 +0,4	with filter	
		SAE 10W-30CD										
		SAE 15W-40CD										
Travel reduction gear	Gear oil	SAE 90 (GL-4)						-	0,4	0,4	for each reduction gear	
Hydraulic oil system	Hydraulic oil	ISO VG46						16,5	26,0	26,0	in the tank	
								9,5	13,0	13,0	the rest	
Fuel tank	Ligh oil	No.2-D						20,0	28,5	28,5		
		No.3-D										
		No.3-D (S)										
Cooling system	Water	AMMANN YANMAR genuine long-life coolant (LLC) added						2,7	2,9	2,9	radiator	
								0,4	0,4	0,4	subtank	



17 Fueling, Oiling and Greasing Based on Temperature Range

Components	Fluid	Recommendations with regard to temperature ranges						Prescribed amount (litre)				
		(°F) -4	14	32	50	68	86	ViO30-3	ViO35-3	ViO50U	ViO57U	
		(°C) (-20)	(-10)	(0)	(10)	(20)	(30)					
Engine	Engine oil	SAE 10WCD						4,0 + 0,4	4,0 + 0,4	8,9 + 0,4	8,9 + 0,4	with filter
		SAE 10W-30CD										
		SAE 15W-40CD										
Travel reduction gear	Gear oil	SAE 90 (GL-4)						0,5	0,5	1,2	1,2	for each reduction gear
Hydraulic oil system	Hydraulic oil	ISO VG46						35,0	35,0	38,0	38,0	in the tank
								17,0	17,0	26,0	26,0	the rest
Fuel tank	Ligh oil	No.2-D						37,0	37,0	67,0	67,0	
		No.3-D										
		No.3-D (S)										
Cooling system	Water	AMMANN YANMAR genuine long-life coolant (LLC) added						3,1	3,1	6,3	6,3	radiator
								0,4	0,4	0,4	0,4	subtank

18 Standard Tightening Torque for Bolts and Nuts

18.1 Torque table

Bolts or nuts in the metric system should be tightened at the torque described below unless specified otherwise.

Item		Thread size X pitch	Tightening torque N•m	Remarks
Screw (7T) Nut	Coarse threads	M6×1	9,8 - 11,8	1) Apply 80 % tightening torque if screws or nuts are in aluminium. 2) Apply 60 % tightening torque for 4T bolt and lock nut. 3) Use fine thread screws for engine only.
		M8×1,25	22,6 - 28,4	
		M10×1,5	44,1 - 58,8	
		M12×1,75	78,5 - 98,1	
		M14×2	117,7 - 147,1	
		M16×2	166,7 - 206,0	
		M18×2,5	235,4 - 284,4	
	M20×2,5	323,6 - 402,1		
		Fine threads	M14×1,5	
		M16×1,5	210,9 - 240,3	
PT plug		1/8	9,8	
		1/4	19,6	
		3/8	29,4	
		1/2	58,8	
Pipe joint bolt		M8	12,7 - 16,7	
		M12	24,5 - 34,3	
		M14	39,2 - 49,0	
		M16	49,0 - 58,8	

IMPORTANT

If a part to be tightened is made of resin like a panel board, excessive tightening torque may damage the tightened part. Be careful when tightening.

19 Maintenance Table

Daily and periodic inspection are important to keep the machine in its best condition. The following is a summary of inspection and servicing items by inspection interval. Periodic inspection intervals vary depending on the use, loads, fuels and lube oils used and handling conditions. The following should be treated only as a general standard.

When the time for an inspection approaches, study the relevant pages in the Operation & Maintenance Manual. Keep a record of daily operation and the results of maintenance work.

19.1 Service intervals when using the hydraulic breaker

When a hydraulic breaker is used, the hydraulic oil deteriorates earlier than in usual bucket excavating work. Set up the service time intervals as follows:

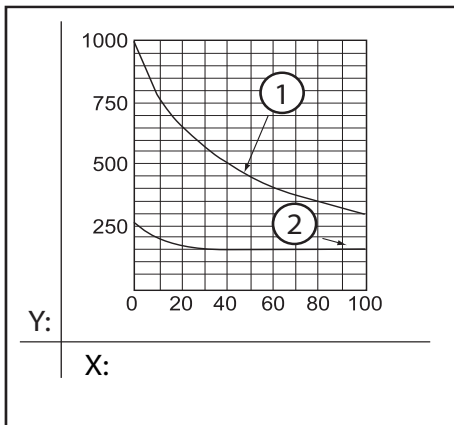

- **Replacing the hydraulic oil return filter element**

Replace the hydraulic oil return filter element on the new machine once after the first 100 to 150 hours. After that, replace it referring to the chart at left.

- **Replacing the hydraulic oil in the hydraulic oil tank**

Replace the hydraulic oil according to the chart at left.

- 1) Hydraulic oil
- 2) Return filter

X: Hydraulic breaker operation rate (%)

Y: Replacement intervals (H)



19.2 List of periodic inspection and servicing

◇: Check ○: Supply ①: Replace first time ●: Replace □: Adjust (clean) ■: Oil and grease

Check & service items Machine		Daily	Every 50h	Every 250h	Every 500h	Every 1000h **
General	Falling off or breakage of parts	◇				
	Retighten bolts and nuts	◇				
	Engine condition	◇				
Lube oil	*Swing gear case		①	○		●
	Travel reduction gear		①	○		●
Hydraulic system	Hydraulic oil	◇				●
	Suction filter					□
	Return filter			①	●	
Grease	Grease-up positions	■				
	Swing gears and Swing bearings		■			
Undercarriage	Track tension	◇				
Pilot	Steering lever	◇				
	Travel lever	◇				
	*Speed change	◇				
	Accelerator lever	◇		□		
Electric equipment	Lights, horn	◇				
	Hourmeter	◇				
	Warning lights	◇				
	Function of electric wiring and battery	◇				



19 Maintenance Table

◇: Check ○: Supply ①: Replace first time ●: Replace □: Adjust (clean) ■: Oil and grease

Check & service items Engine	Daily	Every 50h	Every 250h	Every 500h	Every 1000h **
Fuel tank	○				
Oil/water separator		□			
Fuel filter				●	
Engine oil	◇	①	●		
Oil filter		①	●		
Cooling water	◇				●
Radiator fins			□		
Fan-belt tension			□		
Rubber hose (fuel and cooling water)					◇
*Turbocharger					◇
Air filter			□	●	
Valves					□
Nozzle valves and injection pressure					□
Fuel pump					□

*Applicable to models with the relevant equipment

** Every 1000 hours or once a year

Note :

- When machine is used at dusty worksites clean and replace filter element twice or more frequently than specified in the table.
- Execution of periodic inspection and servicing is indispensable to conform to the EPA emission control regulations. Keep a record of the results.

20 Procedures for Maintenance

20.1 Checking and adjusting the rubber crawler tension

CAUTION

- When adjusting the crawler tension while raising the machine, do not support the machine with the implement only. The control levers could move or the hydraulic oil could flow out accidentally so that the machine would fall.
- When raising the machine, support it with safety blocks of sufficient strength. When the machine is being checked or adjusted by two persons, one must operate the machine in response to signs from the other.

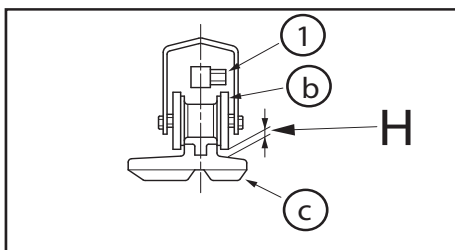
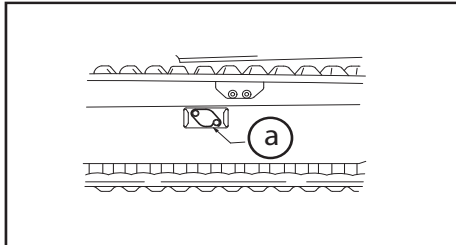
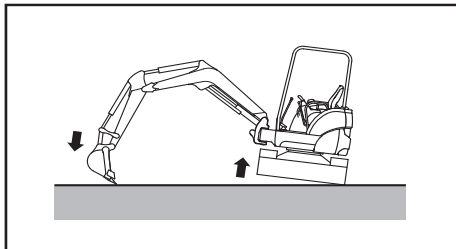

How the crawler wears out depends on the working conditions and the nature of the ground. Be sure to check the crawler for wear and tension from time to time. When a new crawler is mounted, perform the first check after 30 hours operation. Working with the crawler loosened can cause the detrack of the crawler or an earlier wear out.

- 1) Lift the machine with the implement. To do this, operate the control lever slowly.
- 2) The tension of rubber crawlers is proper if the clearance between the outside rolling surface of the second track roller from the idler side and the inside surface of the crawler is within the specified value: H (see the specification table)

1 = Nipple valve
a = Cap
b = Track roller
c = Crawler

- 3) The tension of steel crawlers is proper if the clearance between the lower center of the track frame and the upper surface of the shoe plate is within the specified value: H (see the specification table)

Increasing the crawler tension

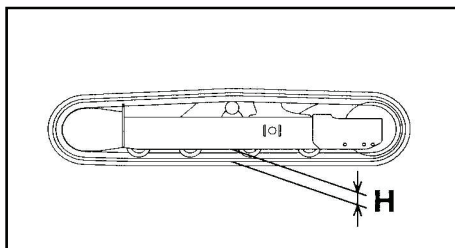

- 4) By using a grease gun, inject grease through the nipple valve (1) until the crawler tension is within the specified value: H

20 Procedures for Maintenance

Loosening the tension

- 5) Slowly loosen the nipple valve (1) and discharge the grease to adjust the crawler tension to the specified value: H

(If the grease is not discharged completely, put down the machine and move the machine back and forth slightly.)

Tighten the nipple valve (1). Tightening torque : 49.0 N•m

⚠ CAUTION

- **Grease is under high pressure. If the nipple valve (1) is loosened suddenly, the grease could be ejected or the valve could blow, which causes bodily injury.**
 - **Do not look at the valve to determine whether grease has been discharged or not, but check that by the tension of the crawler.**
 - **Do not loosen the nipple valve more than one turn.**
 - **It is very dangerous to discharge the grease by any procedure other than that described above.**
 - **If the rubber crawler cannot be loosened, contact your dealer and ask for intervention.**
- 6) To check that the tension is proper, put down the machine and move the machine back and forth slightly.
 - 7) Put back the cap (a).

IMPORTANT

The rubber crawler is not grease-resistant.

Completely wipe off the grease because grease will shorten its service life.

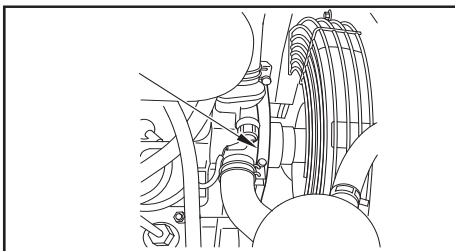

20.2 Checking and adjusting the fan belt tension

- 1) Stop the engine.
- 2) Open the engine hood rear cover.
- 3) Press the fan belt between the fan pulley and the generator with a finger to check the fan belt tension.
Pressing load : Approximately 98,1 N•m
Adequate slack : 10 to 15 mm
- 4) Adjust the tension if necessary.

a = Fan pulley
b = Generator
c = Belt

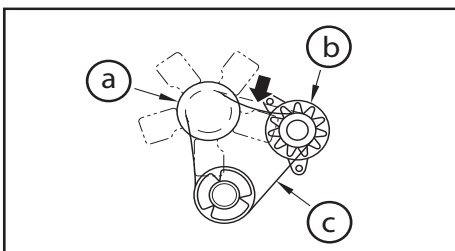

20.3 Greasing (depending on model)

IMPORTANT

Grease the fittings thoroughly after washing the machine or after operation in rain, on soft ground, or in muddy water.

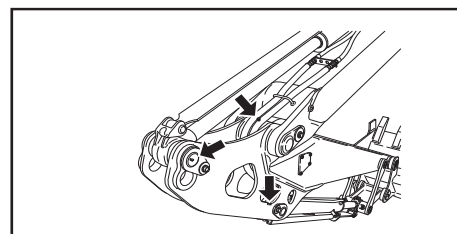
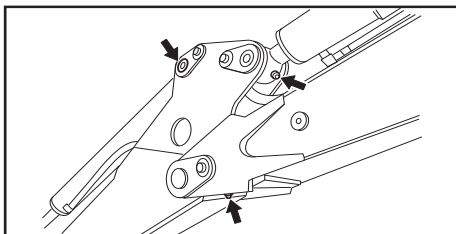
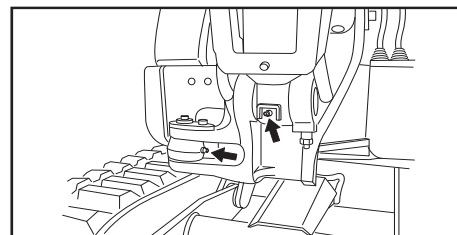
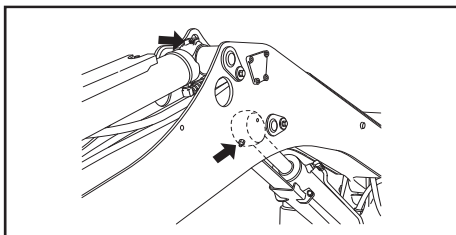
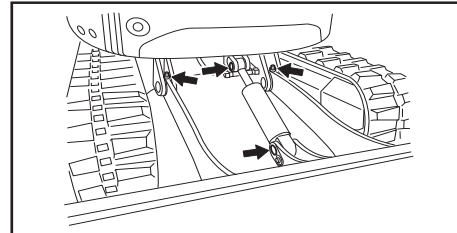
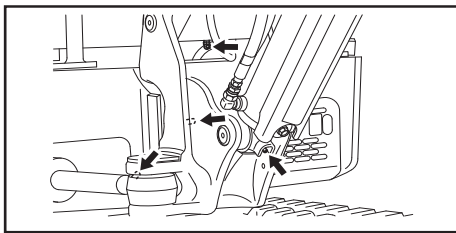
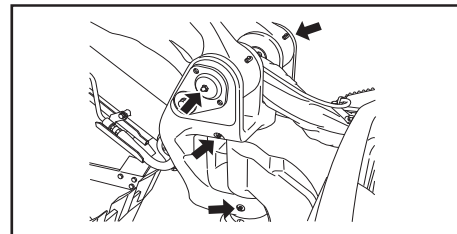
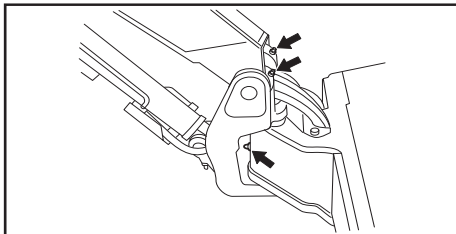
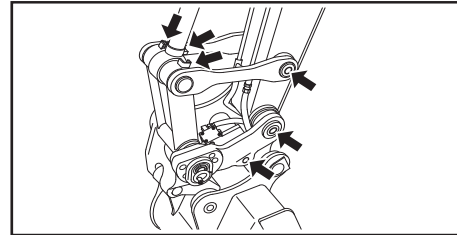
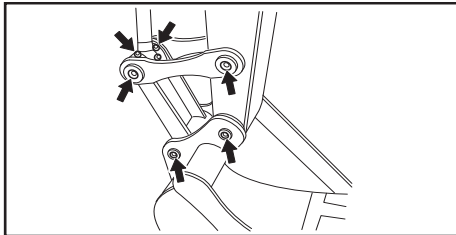

20 Procedures for Maintenance

- 1) Put the bucket and the blade on the ground and stop the engine.
- 2) Clean the grease nipples indicated with the arrows in the above figures and grease them using a grease gun.
- 3) After greasing, wipe off the excessive grease with waste cloth or the like.

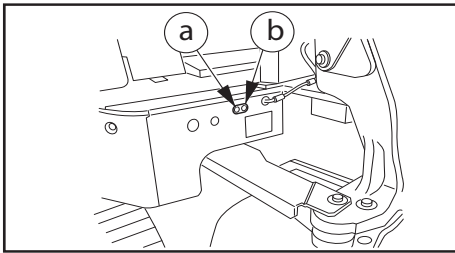

20.4 Greasing the swing gear and the swing bearing

a = Swing bearing
b = Swing gear

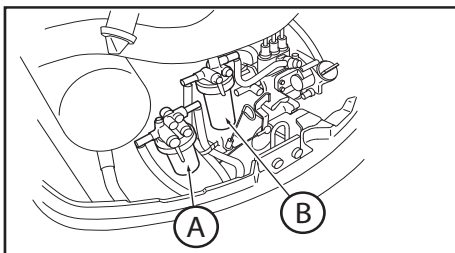

20.5 Changing the water separator element

A = Fuel filter
B = Water separator

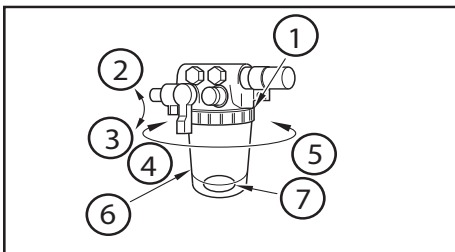

- 1) Retainer ring
- 2) Close
- 3) Open
- 4) Loosen
- 5) Tighten
- 6) Water separator
- 7) Ring

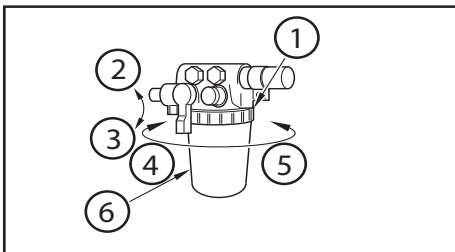

20.6 Changing the fuel filter element

- 1) Retainer ring
- 2) Close
- 3) Open
- 4) Loosen
- 5) Tighten
- 6) Fuel filter

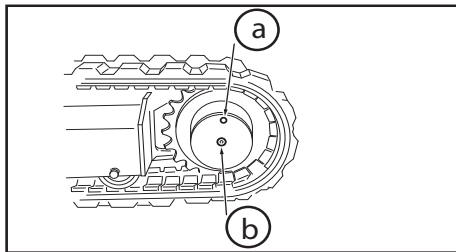

20.7 Checking and replenishing the lube oil for the travel reduction gearbox

a = Oil supply port (drain port)

b = Oil level check port (level port)

20.8 Servicing the air conditioning heater (depending on model)

Every 15 days

- Operate the air conditioning.
- Check suction filters on the air conditioning heater for clogging and replace them if required.
- Check the correct operation (ventilation and speeds) of the heater evaporator and the ventilation on the condenser.
- Check the condenser for clogging: Should it be seriously clogged (impaired air conditioner performance), you can clean it using pressurised air or water; be careful not to damage the condenser blades.
- Very important: Do not place anything in the condenser compartment (rags, papers, straps, etc.) to avoid obstructing the air passage on this exchanger and the risk of impairing the air conditioning performance or even breaking the refrigeration system (compressor breakage)

Every year

WARNING

In the case of operation in extreme atmospheric and mechanical conditions, these checks should be carried out every month.

Check the system operating condition:

- Condenser cleanliness and operation of its ventilation.
- Ventilation speeds on the hot cold exchanger and its cleanliness.
- Temperature regulation.
- Have a refrigeration engineer check the refrigerant charge in R134a.

R134a gas charge: 510 g



1 = Cab air door and suction filter

2 = Protection casings



20 Procedures for Maintenance

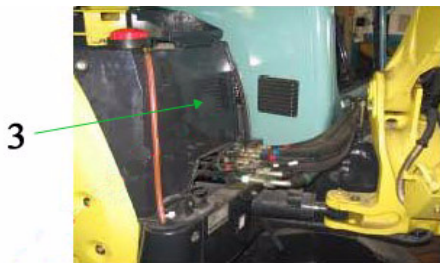

3 = Outside air suction filter



SPECIFICATIONS





21 Specifications

21.1 Specifications

		ViO17
Crawlers		rubber
H (crawler tension)	mm	8~13
Items		Canopy

Weight (in compliance with CE standards)

Operating mass (with operator + 75 kg)	kg	1740
--	----	------

Working range and performance

Operating temperature range	°C	-15 ~ 40
Bucket capacity, standard	m ³	0,05
Bucket width, standard	mm	450
Maximum digging depth	mm	2310
Maximum vertical wall digging depth	mm	1850
Maximum cutting height	mm	3690
Maximum dumping height	mm	2630
Maximum digging radius of the ground	mm	3710
Front minimum swing radius	mm	1535
Boom swing angle : left / right		42° / 65°
Maximum digging force : bucket / arm	kN	15,2
Travel speed : high / low	km / h	4,3 / 2,1
Maximum gradient		30°
Swing speed	rpm	9,5
Average ground pressure, standard crawler	kg / cm ²	0,291
Hydraulic pump displacement	L / min	17,6x2 <Variable displacement pumps> 13,2x1 <Gear pump> 9,9x1 <Trochoid pump>
System relief set pressure	MPa	20,6x2; 16,7x1; 2,9x1

Engine		ViO17
Type	-	Vertical three cycle water-cooled diesel engine
Model	-	YANMAR 3TNV70 - XBV
Rated output / revs	kW / rpm	10,1 / 2200
Displacement	cm ³	854
Compression pressure	MPa	3,2 at 250 rpm
Nozzle injection pressure	MPa	12,3
Generator capacity	V / A	12 / 20

Subject to technical modifications



21 Specifications

	ViO20-3		ViO25-3	
Crawlers	rubber / steel	rubber / steel	rubber / steel	rubber / steel
H (crawler tension) mm	8~13 / 105~115	8~13 / 105~115	8~13 / 105~115	8~13 / 105~115
Items	Canopy	Cabine	Canopy	Cabine

Weight (in compliance with CE standards)

Operating mass (with operator + 75 kg) kg	2215 / 2245	2320 / 2350	2665/2785	2770/2890
---	-------------	-------------	-----------	-----------

Working range and performance

Operating temperature range °C	-15 ~ 40		-15 ~ 40	
Bucket capacity, standard m ³	0,08		0,08	
Bucket width, standard mm	490		490	
Maximum digging depth mm	2505		2740/2600	
Maximum vertical wall digging depth mm	2105		2250	
Maximum cutting height mm	3995		4180	
Maximum dumping height mm	2740		2850	
Maximum digging radius of the ground mm	4255		4510	
Front minimum swing radius <at swinging the boom> mm	1815 <1550>		1900 <1600>	
Boom swing angle : left / right	47° / 75°		47° / 75°	
Maximum digging force : bucket / arm kN	18,6		24,5	
Travel speed : high / low km / h	4,4 / 2,2		4,0 / 3,8 2,6 / 2,4	
Maximum gradient	30°		30°	
Swing speed rpm	9,5		9,5	
Average ground pressure, standard crawler kg / cm ²	0,38	0,4	0,30/0,31	0,31/0,32
Hydraulic pump displacement L / min	21,6 X 2 <Variable displacement pumps> 21,1 X 1 <Gear pump>		30,0 X 2 <Variable displacement pumps> 21,5 X 1 <Gear pump>	
System relief set pressure MPa	P1: 20,6 / P2: 20,6 / P3: 16,7		P1: 20,6 / P2: 20,6 / P3: 16,7	

Engine		ViO20-3	ViO25-3
Type	-	Vertical three cycle water-cooled diesel engine	Vertical three cycle water-cooled diesel engine
Model	-	YANMAR 3TNV76 - PBV	YANMAR 3TNV76 - NBVA
Rated output / revs	kW / rpm	14,3 / 2400	15,2 / 2500
Displacement	cm ³	1115	1115
Compression pressure	MPa	3,43 at 250 rpm	3,4 at 250 rpm
Nozzle injection pressure	MPa	11,8 ~ 12,8	11,8 ~ 12,7
Generator capacity	V / A	12 / 40	12 / 40
Type	V / Ah	12 / 45	12 / 45

Subject to technical modifications



21 Specifications

	ViO30-3		ViO35-3	
Crawlers	rubber / steel	rubber / steel	rubber / steel	rubber / steel
H (crawler tension) mm	8~13 /105 ~115	8~13 /105 ~115	8~13 /105 ~115	8~13 /105 ~115
Items	Canopy	Cabine	Canopy	Cabine

Weight (in compliance with CE standards)

Operating mass (with operator + 75 kg) kg	3140	3270	3435	3565
---	------	------	------	------

Working range and performance

Operating temperature range °C	-15 ~ 40		-15 ~ 40	
Bucket capacity, standard m ³	0,10		0,11	
Bucket width, standard mm	540		590	
Maximum digging depth mm	2800		3150	
Maximum vertical wall digging depth mm	2400		2700	
Maximum cutting height mm	4560		4820	
Maximum dumping height mm	3150		3420	
Maximum digging radius of the ground mm	4650		5000	
Front minimum swing radius <at swinging the boom> mm	1880 <1550>		1980 <1620>	
Boom swing angle : left / right	50° / 75°		50° / 75°	
Maximum digging force : bucket / arm kN	27,5		28	
Travel speed : high / low km / h	4,6 / 2,7		4,6 / 2,7	
Maximum gradient	30°		30°	
Swing speed rpm	10		10	
Average ground pressure, standard crawler kg / cm ²	0,293	0,305	0,320	0,332
Hydraulic pump displacement L / min	38,75 X 2 <Variable displacement pumps> 21,25 X 1 <Gear pump>		38,75 X 2 <Variable displacement pumps> 23,75 X 1 <Gear pump>	
System relief set pressure MPa	P1: 20,6 / P2: 20,6 / P3: 20,6		P1: 20,6 / P2: 20,6 / P3: 20,6	

Engine		ViO30-3	ViO35-3
Type	-	Vertical three cycle water-cooled diesel engine	Vertical three cycle water-cooled diesel engine
Model	-	3TNV82A - XBVA	3TNV82A - XBVA
Rated output / revs	kW / rpm	18,4 / 2500	18,4 / 2500
Displacement	cm ³	1331	1331
Compression pressure	MPa	3,0 at 300 rpm	3,0 at 300 rpm
Nozzle injection pressure	MPa	19,6	19,6
Generator capacity	V / A	12 / 40A	12 / 40A
Type	V / Ah	12 / 72	12 / 72

Subject to technical modifications.



21 Specifications

	ViO50U	ViO57U
S/N°	EA2B	FA2B
Crawlers	rubber / steel	rubber / steel
H (crawler tension) mm	8~13 /105 ~115	8~13 /105 ~115
Items	Cabine	Cabine

Weight (in compliance with CE standards)

Operating mass (with operator + 75 kg) kg	4621 / 4691	5321 / 5391
---	-------------	-------------

Working range and performance

Operating temperature range °C	-15 ~ 40	-15 ~ 40
Bucket capacity, standard m ³	0,11	0,11
Bucket width, standard mm	500	500
Maximum digging depth mm	3550	3730
Maximum vertical wall digging depth mm	2730	2900
Maximum cutting height mm	5550	5890
Maximum dumping height mm	3890	4320
Maximum digging radius of the ground mm	5640	5965
Front minimum swing radius <at swinging the boom> mm	2215 <1975>	2135 <1905>
Boom swing angle : left / right	70° / 70°	70° / 70°
Maximum digging force : bucket / arm kN	37,6	42,8
Travel speed : high / low km / h	4,6 / 4,2 2,3 / 2,1	4,3 / 4,3 2,3 / 2,1
Maximum gradient	30°	30°
Swing speed rpm	10	10
Average ground pressure, standard crawler kg / cm ²	0,295 / 0,268	0,289 / 0,3
Hydraulic pump displacement L / min	40,3 X 2 <Variable displacement pumps> 40,3 X 1 <Gear pump>	40,3 X 2 <Variable displacement pumps> 40,3 X 1 <Gear pump>
System relief set pressure MPa	P1:21,6 / P2: 21,6 / P3: 21,6	P1: 24,5/ P2: 24,5 / P3: 24,5

Engine		ViO50U	ViO57U
Type	-	Vertical four cycle water-cooled diesel engine	Vertical four cycle water-cooled diesel engine
Model	-	4TNV88 - BXBVA	4TNV88 - BXBVA
Rated output / revs	kW / rpm	30,2 / 2400	30,2 / 2400
Displacement	cm ³	2190	2190
Compression pressure	MPa	3,43 at 250 rpm	3,43 at 250 rpm
Nozzle injection pressure	MPa	19,6 ~ 20,6	19,6 ~ 20,6
Generator capacity	V / A	12 / 40	12 / 40
Type	V / Ah	12 / 95	12 / 95

Subject to technical modifications.

21.2 Model view and working range (Cabin / Canopy)

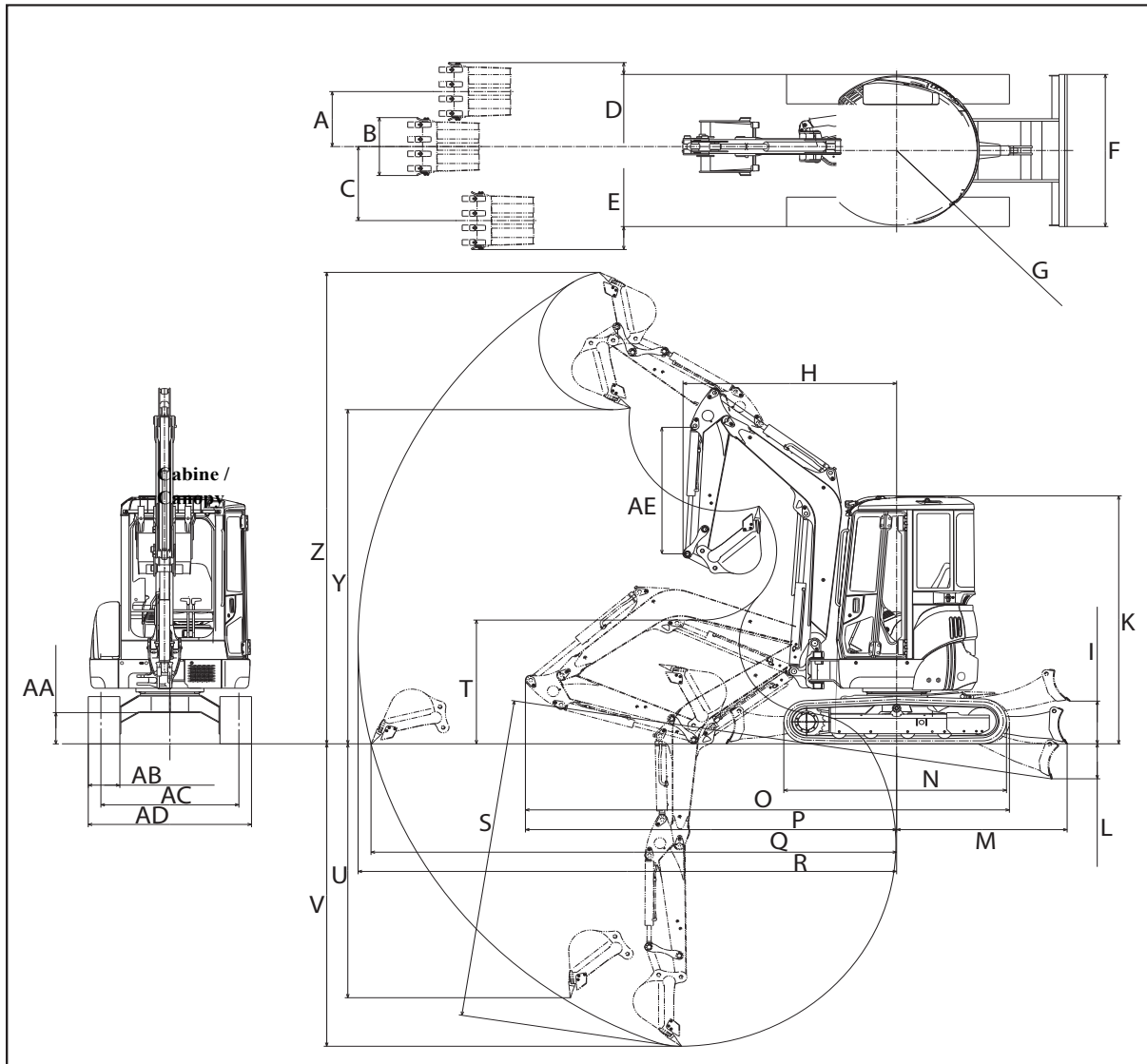



21 Specifications

Unit: mm	ViO17	ViO20-3	ViO25-3	ViO30-3	ViO35-3
A	400	485	494	560	560
B	450	490	490	540	590
C	640	700	714	755	755
D	250* / 85	95	73	95	120
E	290* / 125	200	174	210	235
F	1280	1380	1450	1550	1550
G	640	R 690	R 725	R 765	R 775
H / (swing)	1535 / (1380)	1815 / (1550)	1900 / (1600)	1880 / (1550)	1980 / (1620)
I	260	370	335	350	435
K Cabine / Canopy	- / 2300	2458 / 2458	2528 / 2528	2530 / 2530	2530 / 2530
L	205	340	350	320	360
M	1120	1270	-	1410	1610
N	1525	1890	2020	2120	2120
O	3450	3895	4100	4325	4595
P	2665	4220	-	4675	5145
Q	3710	4255	4400	4650	5000
R	3810	4360	4510	4800	5120
S	2310	2690	2740	2950	3300
T	1025	810	995	1159	1280
U	1850	2105	2250	2400	2700
V	2200	2505	2600	2800	3150
Y	2630	2740	2830	3150	3420
Z	3690	3995	3990	4560	4820
AA	175	280	320	320	320
AB	230	250	260	300	300
AC	1050* / 720	1160	1210	1310	1310
AD	1280* / 950	1380	1450	1550	1550

*widen track gauge value



21 Specifications

Unit: mm	ViO50U	ViO50U long-arm	ViO57U	ViO57U long-arm
A	757	757	757	757
B	500	500	500	500
C	673	673	673	673
D	82	82	72	72
E	-2	-12	-12	
F	1970	1970	1970	1970
G	975	975	975	975
H / (swing)	2220	2220	2125	2125
I	460	460	460	460
K Cabine / Canopy	2640	2640	2640	2640
L	530	530	530	530
M	1900	1900	1900	1900
N	2580	2580	2580	2580
O	4866	4811	5097	5142
P	3891	3836	4122	4167
Q	5640	5837	5965	6283
R	5800	5990	6110	6424
S	3720	3900	3900	4286
T	1380	1012	1310	1203
U	2730	2889	2900	3148
V	3550	3746	3730	4059
Y	3890	4011	4320	4537
Z	5550	5667	5890	6197
AA	355	355	355	355
AB	350	350	400	400
AC	1670	1670	1670	1670
AD	1970	1970	1990	1990
AE	1650	1850	1690	2030



21 Specifications

21.3 Noise emitted by the machines

Results of inspections:

	ViO17	ViO20-3	ViO25-3	ViO30-3	ViO35-3	ViO50U	ViO57U
LwA (dBA)	93	91	93	93	93	95	96
LpA/LAeq (dBA)	70	82	81	85	85	83	82
LpCrête (dBC)	< 130	< 130	< 130	< 130	< 130	< 130	< 130

Rounded values

LwA: Weighted sound power level A.

LpA/LAeq: Weighted sound pressure level A on the operator's ears.

LpCrête: Maximum value of the instantaneous sound pressure measured with frequency weighting C.

Measurements made:

- Machine in static position
- Motor running at rated power

LwA: Determined and guaranteed in accordance with the directive 2000/14/CE amended by the directive 2005/88/CE.

LpA/LAeq: Measured and guaranteed in accordance with the NF-ISO 6396: 1997 standard.

Note: These values are declared in accordance with the directive 98/37/CE and do not correspond to exposure values for 8 hours of work.

21.4 Vibrations emitted by the machines

Results of inspections:

Machine	Entire body in m/s ² (Threshold value < 0.5)			Arms in m/s ² (Threshold value < 2.5)		
	VRD trench	Backfill	Travel on grass	VRD trench	Backfill	Travel on grass
ViO17	< 0,5	1,1	1,0	< 2,5	< 2,5	2,7
ViO20-3	< 0,5	1,0	0,8	< 2,5	< 2,5	< 2,5
ViO25-3	< 0,5	1,0	0,9	< 2,5	< 2,5	< 2,5
ViO30-3	< 0,5	1,3	1,1	< 2,5	2,7	3,5
ViO35-3	0,5	1,1	2,0	2,5	< 2,5	2,6
ViO50U	< 0,5	1,0	1,3	< 2,5	< 2,5	< 2,5
ViO57U	< 0,5	0,9	1,1	< 2,5	< 2,5	< 2,5

These are mean acceleration values established according to the cycles below.

Rounded values

Measurements made:

- **VRD Trench:** 5 digging and dumping cycles to the left at 45°.
- **Backfill:** 3 backfill cycles.
- **Travel on grass:** One to and fro trip of about 1 minute with numerous changes in direction.

Measured in accordance with the ISO EN 1032 (2003) standard for the entire body and with the NF EN ISO 5349-1 (2002) and NF EN ISO 5349-2 (2001) standards for the arm system.

Note: These values are declared in accordance with the directive 98/37/CE and do not correspond to exposure values for 8 hours of work.

To transmit minimum vibrations over the entire body during operation of the machine and avoid harming the operator's health, it is recommended that the following measures be taken:

- Adjust the seat according to the operator's height.
- Maintain the ground in a good condition.
- Use the machine under suitable conditions, by considering the actual ground conditions and the specific effects of vibrations caused by the actual operating mode of the machine.
- It is recommended that the operator acquaint himself with and retain the instructions relating to the setting up and use of attachments.

21 Specifications

21.5 Lifting capacity

Lifting capacity for ViO17

Machine with rubber tracks.
 Bucket width: 400 mm Bucket weight: 38 kg
 A : Overhang from the axis of rotation
 B : Bucket height in meters
 C : Load point

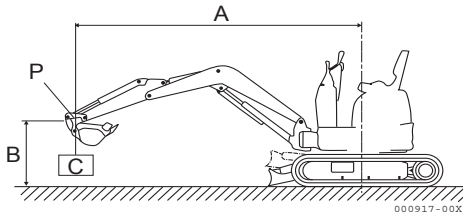

Longitudinal boom



Transverse boom

Blade down (N = retracted track W = widen track)

Unit : (kg)

A (m)	Max			2,5 m			2,0 m			Min		
	N	W		N	W		N	W		N	W	
2,0	145	240	*300	210	*315	*295	-	-	*295	250	*310	-
1,5	130	220	*305	200	*370	*310	310	*420	*355	-	-	-
1,0	115	205	*305	185	305	*365	260	440	*480	325	555	*415
0,5	115	205	*310	175	300	*410	240	425	*575	285	505	*625
0	95	210	*320	170	285	*450	230	400	*625	290	505	*745
-0,5	135	230	*330	165	290	*435	240	400	*600	-	-	*810
-1,0	160	270	*325	-	-	-	235	405	*510	-	-	-

Blade up (N = retracted track W = widen track)

Unit : (kg)

A (m)	Max			2,5 m			2,0 m			Min		
	N	W		N	W		N	W		N	W	
2,0	140	200	215	205	*295	*295	-	*290	*295	245	-	-
1,5	125	175	195	195	250	*310	305	*355	*350	-	*415	*410
1,0	115	170	185	180	250	270	255	345	375	310	430	470
0,5	115	165	180	175	245	265	235	320	365	280	390	450
0	115	175	185	170	235	260	220	310	350	280	470	525
-0,5	130	190	200	160	235	255	240	305	345	-	-	-
-1,0	155	230	260	-	-	-	230	320	355	-	-	-

The data in these tables represents the lifting capacity according to the ISO 10567 standard. It corresponds to 75% of the maximum static load before tipping or to 87% of the hydraulic working load. The data marked with * conveys the hydraulic limits of the working load.

21 Specifications

Lifting capacity for ViO20-3

Machine with rubber tracks.

Bucket width: 490 mm Bucket weight: 52 kg

A : Overhang from the axis of rotation

B : Bucket height in meters

C : Load point

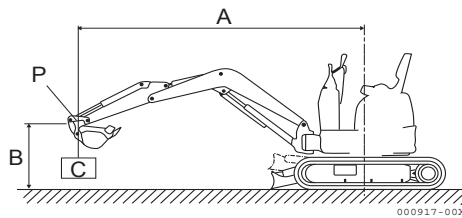

Longitudinal boom

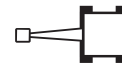

Transverse boom

Blade down

Unit : (kg)

A (m)	Max		3,0 m		2,5 m		2,0 m	
B (m)								
3,4	*390	*390	-	-	-	-	-	-
2,5	290	*405	-	-	*335	*335	-	-
2,0	245	*405	320	*400	*390	*390	-	-
1,5	215	*425	305	*530	*495	*495	-	-
1,0	200	*425	270	*510	420	*615	605	*790
0	210	*460	290	*600	390	*770	515	*1095
-1,0	275	*475	-	-	375	*700	515	*980
-1,5	330	*500	-	-	-	-	540	*735

Blade up

Unit : (kg)

A (m)	Max		3,0 m		2,5 m		2,0 m	
B (m)								
3,4	*390	*390	-	-	-	-	-	-
2,5	290	320	-	-	*335	*335	-	-
2,0	245	275	320	*400	*390	*390	-	-
1,5	215	245	305	335	*495	*495	-	-
1,0	200	240	270	350	420	470	605	*790
0	210	245	290	335	390	440	515	605
-1,0	275	305	-	-	375	435	515	620
-1,5	360	440	-	-	-	-	540	615

The data in these tables represents the lifting capacity according to the ISO 10567 standard. It corresponds to 75% of the maximum static load before tipping or to 87% of the hydraulic working load. The data marked with * conveys the hydraulic limits of the working load.

21 Specifications

Lifting capacity for ViO25-3

Machine with rubber tracks.
 Bucket width: 400 mm Bucket weight: 78 kg
 A : Overhang from the axis of rotation
 B : Bucket height in meters
 C : Load point

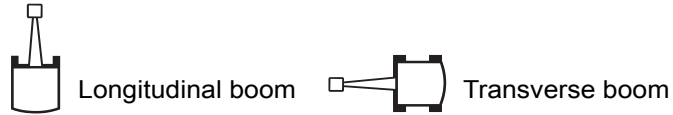
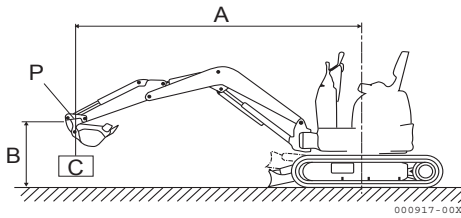

Blade down

Unit : (kg)

A (m)	Max		3,0 m		2,5 m		2,0 m	
B (m)								
3,0	395	*520	-	-	-	-	-	-
2,5	320	*510	*450	*450	-	-	-	-
2,0	275	*490	*510	*510	-	-	-	-
1,0	250	*510	385	*655	530	*820	730	*1160
0	250	*525	380	*725	490	*920	680	*1310
-1,0	340	*525	370	*620	490	*840	700	*1135
-1,5	480	*480	-	-	*600	*600	*830	*830

Blade up

Unit : (kg)

A (m)	Max		3,0 m		2,5 m		2,0 m	
B (m)								
3,0	395	*490	-	-	-	-	-	-
2,5	320	395	*450	*450	-	-	-	-
2,0	275	335	*510	*510	-	-	-	-
1,0	250	305	385	470	530	635	730	910
0	250	310	380	455	490	605	680	845
-1,0	340	395	370	455	490	605	700	890
-1,5	*480	*480	-	-	*600	*600	*830	*830

The data in these tables represents the lifting capacity according to the ISO 10567 standard. It corresponds to 75% of the maximum static load before tipping or to 87% of the hydraulic working load. The data marked with * conveys the hydraulic limits of the working load.

Lifting capacity for ViO25-3 ARM LONG

Note: It is not advisable to use the hydraulic breaker with the ARM LONG.

Machine with rubber tracks.

Bucket width: 400 mm Bucket weight: 78 kg

A : Overhang from the axis of rotation

B : Bucket height in meters

C : Load point

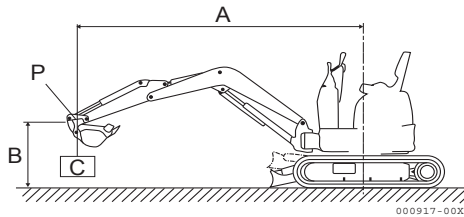

Longitudinal boom

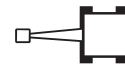

Transverse boom

Blade down

Unit : (kg)

A (m)	Max		3,0 m		2,5 m		2,0 m	
B (m)								
3,0	*390	*390	-	-	-	-	-	-
2,5	280	*395	-	-	-	-	-	-
2,0	250	*415	*400	*400	-	-	-	-
1,0	210	*445	380	*565	510	*685	730	*930
0	220	*465	360	*730	500	*945	695	*1150
-1,0	285	*485	365	*685	495	*895	655	*980
-1,5	355	*440	-	-	470	*695	360	*940

Blade up

Unit : (kg)

A (m)	Max		3,0 m		2,5 m		2,0 m	
B (m)								
3,0	*390	*390	-	-	-	-	-	-
2,5	280	*395	-	-	-	-	-	-
2,0	250	285	*400	*400	-	-	-	-
1,0	210	265	380	455	510	*685	730	*930
0	220	275	360	455	500	620	695	780
-1,0	285	350	365	460	495	615	655	660
-1,5	355	*440	-	-	470	555	360	*940

The data in these tables represents the lifting capacity according to the ISO 10567 standard. It corresponds to 75% of the maximum static load before tipping or to 87% of the hydraulic working load. The data marked with * conveys the hydraulic limits of the working load.

21 Specifications

Lifting capacity for ViO30-3

Machine with rubber tracks.
 Bucket width: 540 mm Bucket weight: 86 kg
 A : Overhang from the axis of rotation
 B : Bucket height in meters
 C : Load point

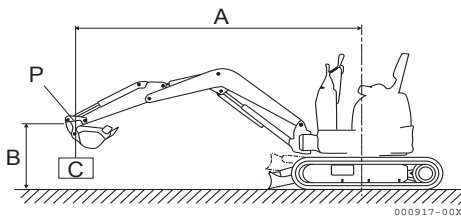

Longitudinal boom



Transverse boom

Blade down

Unit : (kg)

A (m)	Max		3,0 m		2,5 m		2,0 m	
B (m)								
3,0	430	*680	*620	*620	-	-	-	-
2,5	360	*700	540	*700	*660	*660	-	-
2,0	330	*700	540	*770	730	*880	-	-
1,0	290	*700	490	*1010	680	*1300	870	*1750
0	310	*750	490	*1140	630	*1450	910	*1960
-1,0	410	*750	480	*940	640	*1270	930	*1730
-1,5	520	*730	-	-	640	*960	940	*1310

Blade up

Unit : (kg)

A (m)	Max		3,0 m		2,5 m		2,0 m	
B (m)								
3,0	430	490	*620	*620	-	-	-	-
2,5	630	430	540	*660	*660	*660	-	-
2,0	330	390	540	630	720	*830	-	-
1,0	290	350	490	540	680	790	870	1060
0	310	360	490	570	630	760	910	1090
-1,0	400	480	480	580	640	760	930	1130
-1,5	520	630	-	-	640	760	940	1090

The data in these tables represents the lifting capacity according to the ISO 10567 standard. It corresponds to 75% of the maximum static load before tipping or to 87% of the hydraulic working load. The data marked with * conveys the hydraulic limits of the working load.

Lifting capacity for ViO30-3 ARM LONG

Note: It is not advisable to use the hydraulic breaker with the ARM LONG.

Machine with rubber tracks.

Bucket width: 400 mm Bucket weight: 78 kg

A : Overhang from the axis of rotation

B : Bucket height in meters

C : Load point

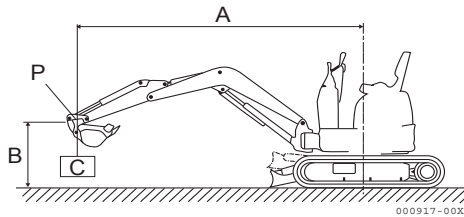

Longitudinal boom

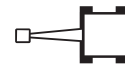

Transverse boom

Blade down

Unit : (kg)

A (m)	Max		3,5 m		3,0 m		2,5 m		2,0 m	
B (m)										
3,0	375	*565	*475	*520	-	-	-	-	-	-
2,5	300	*585	410	*630	*585	*695	-	-	-	-
2,0	280	*565	430	*670	525	*780	710	*1000	1010	*1435
1,0	280	*605	375	*780	400	*975	510	*1195	710	*1565
0	375	*695	410	*935	495	1215	655	*1670	785	*1670
-1,0	355	*650	-	-	410	*800	525	*1000	615	1005
-1,5	*540	*585	-	-	-	-	525	*783	800	800

Blade up

Unit : (kg)

A (m)	Max		3,5 m		3,0 m		2,5 m		2,0 m	
B (m)										
3,0	375	*540	*475	*500	-	-	-	-	-	-
2,5	300	390	390	*600	*585	*650	-	-	-	-
2,0	260	300	390	450	500	600	675	890	975	1390
1,0	260	335	335	450	475	560	635	780	895	1080
0	375	430	410	540	465	690	630	1010	765	1140
-1,0	355	485	-	-	390	600	500	*890	600	*975
-1,5	*540	*565	-	-	-	-	*500	*760	690	*780

The data in these tables represents the lifting capacity according to the ISO 10567 standard. It corresponds to 75% of the maximum static load before tipping or to 87% of the hydraulic working load. The data marked with * conveys the hydraulic limits of the working load.

21 Specifications

Lifting capacity for ViO35-3

Machine with rubber tracks.
 Bucket width: 590 mm Bucket weight: 82,5 kg
 A : Overhang from the axis of rotation
 B : Bucket height in meters
 C : Load point

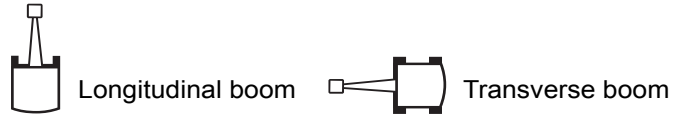
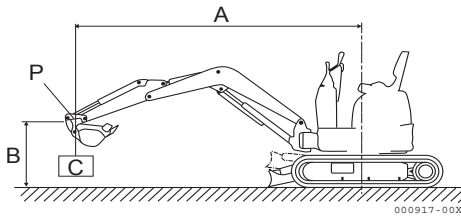

Blade down

Unit : (kg)

A (m)	Max									
B (m)										
3,0	430	*660	530	*630	*590	*590	-	-	-	-
2,0	340	*680	500	*740	*750	*750	*870	*870	-	-
1,0	310	*730	460	*900	600	*1100	970	*1440	-	-
0	300	*740	420	*980	560	*1240	720	*1570	-	-
-1,0	380	*780	420	*900	570	*1180	720	*1420	1000	*1810
-1,5	480	*790	-	-	540	*960	730	*1270	1010	*1540
-2,0	630	*770	-	-	-	-	720	*920	-	-

Blade up

Unit : (kg)

A (m)	Max		3,5 m		3,0 m		2,5 m		2,0 m	
B (m)										
3,0	420	490	530	*630	*590	*590	-	-	-	-
2,0	340	380	390	570	*750	*750	*870	*870	-	-
1,0	310	350	450	530	600	680	780	910	-	-
0	300	360	420	490	560	640	720	840	-	-
-1,0	380	430	420	490	560	640	720	810	1000	1260
-1,5	480	520	-	-	540	620	730	850	1000	1200
-2,0	630	*770	-	-	-	-	720	*920	-	-

The data in these tables represents the lifting capacity according to the ISO 10567 standard. It corresponds to 75% of the maximum static load before tipping or to 87% of the hydraulic working load. The data marked with * conveys the hydraulic limits of the working load.

Lifting capacity for ViO35-3 ARM LONG

Note: It is not advisable to use the hydraulic breaker with the ARM LONG.

Machine with rubber tracks.

Bucket width: 400 mm Bucket weight: 78 kg

A : Overhang from the axis of rotation

B : Bucket height in meters

C : Load point

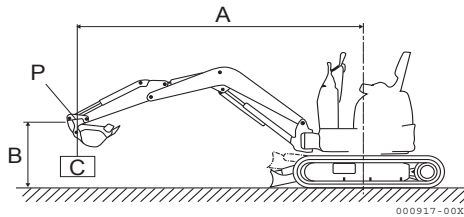

Longitudinal boom

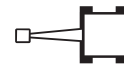

Transverse boom

Blade down

Unit : (kg)

A (m)	Max		3,5 m		3,0 m		2,5 m		2,0 m	
B (m)										
3,0	315	*500	-	-	-	-	-	-	-	-
2,5	260	*540	*565	*585	*600	*600	-	-	-	-
2,0	240	*585	450	*780	560	*935	765	*1215	-	-
1,0	240	*605	375	*870	465	*1105	600	*1500	805	*1975
0	280	*650	355	*870	450	*1150	650	*1455	730	*1975
-1,0	335	*630	315	*780	430	*1000	600	*1410	690	*1540
-1,5	410	*695	-	-	430	*890	505	*910	750	*1150

Blade up

Unit : (kg)

A (m)	Max		3,5 m		3,0 m		2,5 m		2,0 m	
B (m)										
3,0	315	375	-	-	-	-	-	-	-	-
2,5	260	315	*540	*565	*605	*585	-	-	-	-
2,0	240	300	450	505	560	655	765	880	-	-
1,0	240	300	375	465	465	600	580	805	765	1030
0	280	335	355	450	430	580	540	765	710	1085
-1,0	315	375	335	430	410	540	580	765	665	965
-1,5	390	505	-	-	410	580	485	655	690	860

The data in these tables represents the lifting capacity according to the ISO 10567 standard. It corresponds to 75% of the maximum static load before tipping or to 87% of the hydraulic working load. The data marked with * conveys the hydraulic limits of the working load.

21 Specifications

Lifting capacity for ViO50U (Arm 1500)

Machine with rubber tracks.
 Bucket width: 500 mm Bucket weight: 115 kg
 A : Overhang from the axis of rotation
 B : Bucket height in meters
 C : Load point

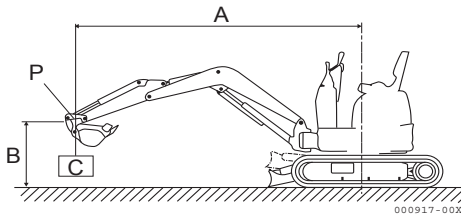

Longitudinal boom

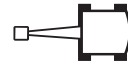

Transverse boom

Blade down

Unit : (kg)

A (m)	Max		4,0 m		3,0 m		2,5 m	
B (m)								
4,0	*790	*830	-	-	-	-	-	-
3,0	510	*880	640	*800	-	-	-	-
2,0	420	*910	620	*990	*1130	*1130	*1410	*1410
1,0	410	*950	590	*1170	1010	*1700	1370	*2300
0	430	*1010	580	*1270	920	*1880	1250	*2420
-1,0	550	*1090	580	*1170	940	*1790	1240	*2280
-2,0	850	*1010	-	-	970	*1310	1310	*1760

Blade up

Unit : (kg)

A (m)	Max		4,0 m		3,0 m		2,5 m	
B (m)								
4,0	700	*830	-	-	-	-	-	-
3,0	510	540	620	*800	-	-	-	-
2,0	410	450	620	660	*1130	*1130	*1410	*1410
1,0	400	420	590	650	990	1080	1280	1390
0	420	470	580	620	910	1010	1230	1370
-1,0	520	570	570	610	1020	930	1230	1390
-2,0	820	900	-	-	970	1040	1280	1470

The data in these tables represents the lifting capacity according to the ISO 10567 standard. It corresponds to 75% of the maximum static load before tipping or to 87% of the hydraulic working load. The data marked with * conveys the hydraulic limits of the working load.

21 Specifications

Lifting capacity for ViO50U (Arm 1650)

Machine with rubber tracks.

Bucket width: 500 mm Bucket weight: 115 kg

A : Overhang from the axis of rotation

B : Bucket height in meters

C : Load point

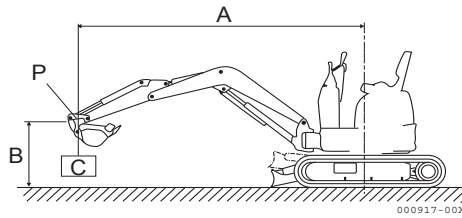

Longitudinal boom

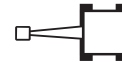

Transverse boom

Blade down

Unit : (kg)

A (m)	Max		4,0 m		3,0 m		2,5 m	
B (m)								
4,0	*700	*855	-	-	-	-	-	-
3,0	535	*900	685	*850	-	-	-	-
2,0	455	*935	650	*995	*1170	*1215	-	-
1,0	430	*970	625	*1180	1000	*1655	1295	*2135
0	440	*1050	590	*1310	920	*1910	1190	*2450
-1,0	520	*1085	590	*1275	910	*1875	1205	*2310
-2,0	805	*1075	-	-	950	*1385	1225	*1650

Blade up

Unit : (kg)

A (m)	Max		4,0 m		3,0 m		2,5 m	
B (m)								
4,0	700	*815	-	-	-	-	-	-
3,0	530	575	685	*759	-	-	-	-
2,0	445	490	650	695	*1160	*1135	-	-
1,0	425	455	520	685	995	1075	1285	1445
0	445	475	590	635	925	1030	1175	1300
-1,0	520	550	590	640	920	980	1190	1325
-2,0	790	805	-	-	920	1000	1175	1325

The data in these tables represents the lifting capacity according to the ISO 10567 standard. It corresponds to 75% of the maximum static load before tipping or to 87% of the hydraulic working load. The data marked with * conveys the hydraulic limits of the working load.

21 Specifications

Lifting capacity for ViO50U ARM LONG

Machine with rubber tracks.

Bucket width: 500 mm Bucket weight: 115 kg

A : Overhang from the axis of rotation

B : Bucket height in meters

C : Load point

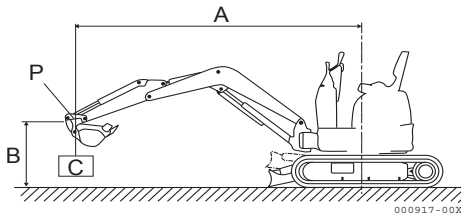

Longitudinal boom

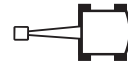

Transverse boom

Blade down

Unit : (kg)

A (m)	Max		4,0 m		3,0 m		2,5 m	
B (m)								
4,0	*635	*635	-	-	-	-	-	-
3,0	420	*370	*635	*618	-	-	-	-
2,0	360	*748	608	*757	*922	*922	-	-
1,0	338	*800	570	*992	998	*1401	1328	*1897
0	360	*870	555	*1166	908	*1697	1208	*2288
-1,0	420	*931	533	*1201	848	*1749	1178	*2236
-2,0	608	*966	-	-	908	*1462	1125	*1801

Blade up

Unit : (kg)

A (m)	Max		4,0 m		3,0 m		2,5 m	
B (m)								
4,0	*635	*618	-	-	-	-	-	-
3,0	420	465	*635	*609	-	-	-	-
2,0	360	405	608	*731	*914	*879	-	-
1,0	338	368	570	645	983	1110	1298	1500
0	345	383	533	608	908	1013	1200	1343
-1,0	420	458	525	578	840	968	1170	1320
-2,0	615	668	-	-	908	983	1133	1305

The data in these tables represents the lifting capacity according to the ISO 10567 standard. It corresponds to 75% of the maximum static load before tipping or to 87% of the hydraulic working load. The data marked with * conveys the hydraulic limits of the working load.

21 Specifications

Lifting capacity for ViO57U

Machine with rubber tracks.

Bucket width: 500 mm Bucket weight: 115 kg

A : Overhang from the axis of rotation

B : Bucket height in meters

C : Load point

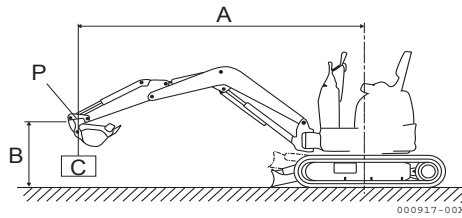

Longitudinal boom

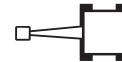

Transverse boom

Blade down

Unit : (kg)

A (m)	Max		4,0 m		3,0 m		2,5 m	
B (m)								
4,0	750	*860	*860	*860	-	-	-	-
3,0	570	*910	*870	*870	-	-	-	-
2,0	490	*940	810	*1090	*1430	*1430	*1850	*1850
1,0	460	*970	780	*1320	1250	*1970	1610	*2650
0	480	*990	750	*1450	1190	*2190	1540	*2710
-1,0	570	*1030	730	*1380	1150	*2050	1560	*2580
-2,0	730	*960	-	-	-	-	1620	*1930

Blade up

Unit : (kg)

A (m)	Max		4,0 m		3,0 m		2,5 m	
B (m)								
4,0	730	*860	*860	*860	-	-	-	-
3,0	560	580	*870	*850	-	-	-	-
2,0	480	510	800	830	*1430	*1430	*1850	*1850
1,0	450	480	760	800	1220	1280	1600	1750
0	470	510	740	780	1170	1230	1520	1650
-1,0	540	580	700	750	1140	1190	1540	1680
-2,0	720	790	-	-	-	-	1600	1700

The data in these tables represents the lifting capacity according to the ISO 10567 standard. It corresponds to 75% of the maximum static load before tipping or to 87% of the hydraulic working load. The data marked with * conveys the hydraulic limits of the working load.

21 Specifications

Lifting capacity for ViO57U ARM LONG

Machine with rubber tracks.

Bucket width: 500 mm Bucket weight: 115 kg

A : Overhang from the axis of rotation

B : Bucket height in meters

C : Load point

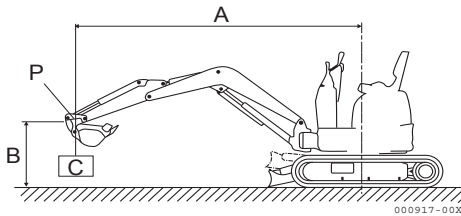

Longitudinal boom



Transverse boom

Blade down

Unit : (kg)

A (m)	Max		5,0 m		4,0 m		3,0 m		2,5 m	
B (m)										
4,0	638	*766	-	-	*687	*696	-	-	-	-
3,0	495	*792	548	*774	*757	*766	-	-	-	-
2,0	443	*809	548	*853	*948	*966	*1209	*1218	-	-
1,0	420	*835	518	*957	803	*1209	1283	*1766	*1444	*1444
0	428	*887	503	*1018	743	*1257	1193	*2062	1718	*2332
-1,0	488	*922	-	-	720	*1392	1148	*2027	1560	*2662
-2,0	645	*948	-	-	743	*1175	1163	*1766	1575	*2532

Blade up

Unit : (kg)

A (m)	Max		5,0 m		4,0 m		3,0 m		2,5 m	
B (m)										
4,0	638	*740	-	-	*661	*661	-	-	-	-
3,0	495	555	548	608	*757	*722	-	-	-	-
2,0	443	465	540	600	*931	*922	*1209	*1183	*1444	*1418
1,0	420	458	518	570	795	840	1268	1380	1688	1883
0	428	465	503	548	743	795	1178	1298	1553	1770
-1,0	488	533	-	-	720	788	1148	1238	1568	1680
-2,0	645	683	-	-	735	795	1163	1260	-	-

The data in these tables represents the lifting capacity according to the ISO 10567 standard. It corresponds to 75% of the maximum static load before tipping or to 87% of the hydraulic working load. The data marked with * conveys the hydraulic limits of the working load.



22 Options

22.1 Options

Installing options not authorised by Ammann-Yanmar can cause accidents and reduce the machine's service life. The installation and use of the unauthorised options or parts can result in the cancellation of the guarantee.

			ViO17	ViO20-3	ViO25-3
1	A	Extension of the arm			
	B	Long arm	○		○ +150 mm
2	A	3rd hydraulic circuit	○	◇	◇
	B	3rd proportional hydraulic circuit	○	◇	◇
	C	4th hydraulic circuit			
	D	4th proportional hydraulic circuit			
3	A	Hoisting ring	○	○	○
	B	Hoisting hook	○	○	○
4		FOPS protective grille on the cab roof	○	○	○
5	A	Safety valves on boom cylinder, and blade cylinder + overload indicator	○	○	○
	B	Safety valves on boom, dipper and blade cylinder + overload indicator	○	○	○
6	A	MED key ignition lock	○	○	○
	B	GAROS keyboard anti-theft device	○	○	○
7	A	Bio standard oil		○	○
	B	Bio Panolin oil		○	○
8		Radio	○	○	○
9		Air conditioning			
10		Mechanical quick coupler	○	○	○
11		Hydraulic quick coupler			
12		Quick coupling	○	○	○
13		Refuelling electrical pump			

○ = Possible options on this machine

◇ = Standard options on this machine



22 Options

			ViO30-3	ViO35-3	ViO50U	ViO57U
1	A	Extension of the arm	○ +500 mm	○ +500 mm	○ 1650 mm	○ 1700 mm
	B	Long arm	○ +250 mm	○ +300 mm	○ 1850 mm	○ 2050 mm
2	A	3rd hydraulic circuit	◇	◇	◇	
	B	3rd proportional hydraulic circuit				◇
	C	4th hydraulic circuit			○	
	D	4th proportional hydraulic circuit				○
3	A	Hoisting ring	○	○	○	○
	B	Hoisting hook	○	○	○	○
4		FOPS protective grille on the cab roof	○	○	○	○
5	A	Safety valves on boom cylinder, and blade cylinder + overload indicator	○	○	○	○
	B	Safety valves on boom, dipper and blade cylinder + overload indicator	○	○	○	○
6	A	MED key ignition lock	○	○	○	○
	B	GAROS keyboard anti-theft device	○	○	○	○
7	A	Bio standard oil	○	○	○	○
	B	Bio Panolin oil	○	○	○	○
8		Radio	○	○	○	◇
9		Air conditioning			○	◇
10		Mechanical quick coupler	○	○	○	○
11		Hydraulic quick coupler			○	○
12		Quick coupling	○	○	○	○
13		Refuelling electrical pump			◇	◇

○ = Possible options on this machine
◇ = Standard options on this machine

(1A) Extension of the arm:

It is advisable not to use the hydraulic breaker with the extension.

(1B) Long arm:

The use of the hydraulic breaker is not advisable with the long arm.

(2A) 3rd hydraulic circuit:

To use the 3rd circuit, refer to Chapter 11.5 "Handling hydraulic P.T.O." in this manual.

(2B) 3rd proportional hydraulic circuit:

It is used to vary the oil flow rate in the circuit.

(2C) 4th hydraulic circuit:

For a machine with a 4th circuit, it can be used through a switch installed on the left control lever.

(2D) 4th proportional hydraulic circuit:

It is used to vary the oil flow rate in the circuit.

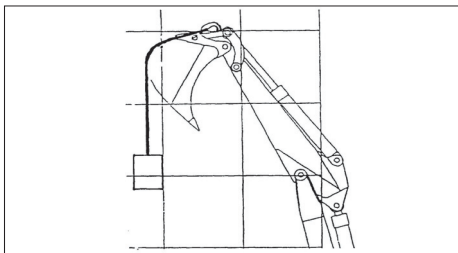

(3A) Hoisting ring:

Safety valves must be installed with the ring. Refer to Chap. 3.3 "Lifting" in this manual.

Check if the ring and the ring assembly base are damaged. If you detect any damage, ask your dealer to intervene.

A suitable ring is required to hang a load on the machine.

For more details, contact your dealer.

The wire or the suspension hook can get detached from the ring if the hook does not remain in the vertical position.

This option is subjected to regular inspections.

(3B) Hoisting hook:

Safety valves must be installed with the hook. Refer to Chap. 3.3 "Lifting" in this manual.

Check if the hook, the locking devices and the assembly base of the hook are damaged.

If any damage is detected, ask your dealer to intervene.

A suitable hook is required to hang a load on the machine.

For more details, contact your dealer.

The wire or the hang-up ring may come off the hook if the hook does not remain in the vertical position.

This option is subjected to a periodic inspection.

(4) FOPS protective grille on the cab roof:

FOPS 2 protective grille for demolition work.



(5A) Safety valves on boom cylinder and blade cylinder + overload indicator:

Safety valves to be installed with the hook or the ring. These valves are installed on the boom and blade cylinder of the machine to avoid the attachment from falling to the ground in case of rupture of hoses. An overload warning indicates that the overload zone is approaching. An ON/OFF button is used to select this function.

(5B) Safety valves on boom, arm and blade cylinder + overload indicator:

Safety valves to be installed with the hook or the ring. These valves are installed on the boom, arm and blade cylinders of the machine to prevent the attachment from falling to the ground in case of rupture of hoses. An overload warning indicates that the overload zone is approaching. An ON/OFF button is used to select this function.

(6A) MED key ignition lock:

To start the engine, insert the MED electronic key in its slot, remove it and start the engine within 30 seconds. If 30 seconds have elapsed, repeat the entire procedure. The ignition lock device gets activated 30 seconds after the ignition key is turned to the OFF position.

(6B) GAROS keyboard anti-theft device:

Once the user's code has been programmed, directly type the code 4 digits and validate using button 'V'. When the code is recognised, the green light (LH side) comes on. Then, turn the start key within 60 seconds.

(7A) Bio standard oil:

The machine can operate with Bio oil.

(7B) Bio Panolin oil:

The machine can operate with Bio Panolin oil. The percentage of mineral oil mixed with the BIO oil should not exceed 2%. Refer to the VDMA 24 569 technical data sheet of March 1994.

(8) Radio:

Refer to the operating instructions provided with the radio.

(9) Air-conditioning:

Refer to the "OPERATION" part in the user manual.

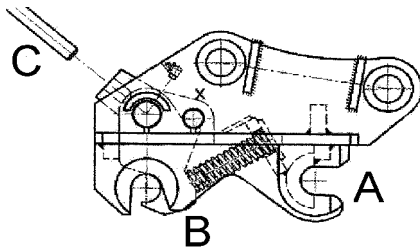

(10) Mechanical quick coupler:

Hooking:

Place hook A on the bucket pin. Pivot the quick coupler around this pin to latch spring part B.

Unhooking:

Take lever C and insert it into the sleeve provided. Actuate the spring. Pivot the quick coupler around the bucket pin. Release the quick coupler hook from the bucket pin.

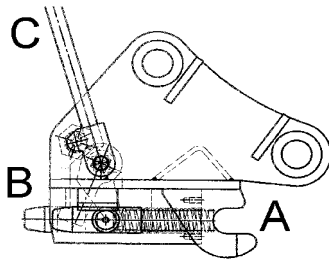

(11) Hydraulic quick coupler

Features of quick coupler

The quick coupler is the device to simplify the replacement of a variety of attachments for hydraulic implement. The distance between pins is adjustable so that the attachments with different distances between pins are available.

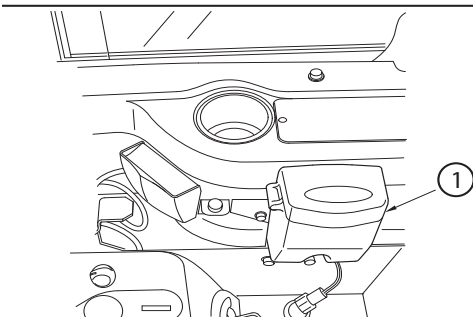

Description of switches

- 1) Switch box

⚠ WARNING

Never open the Switch Box cover except when mounting or dismounting the Attachment to prevent accidental activation of the Quick Coupler.

This may cause breakdown or sudden operation of the Attachment, causing serious accident.

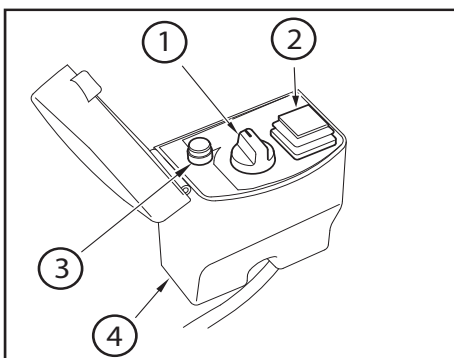

- 1) Control switch
- 2) Power supply switch
- 3) Lamp
- 4) Switch box

1) Control switch of quick coupler

Use this switch to dismount or mount the attachment.

22 Options

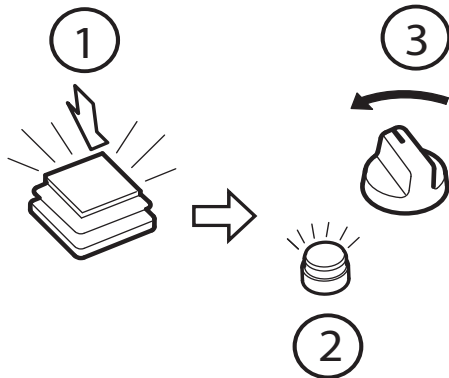

Dismounting of attachment:

- 1) Press (1) - Power supply, switch goes on and beep sounds. Then lamp (2) goes on
- 2) Turn (3) to the left.

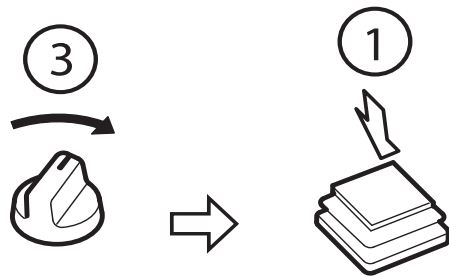

Mounting of attachment

- 1) Turn (3) to the right
- 2) Press (1)

Structure of quick coupler

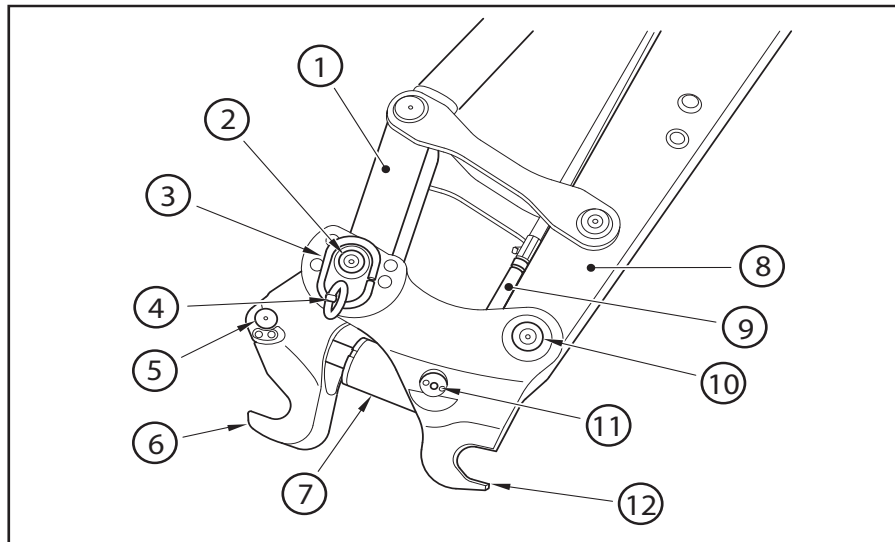

- | | |
|--------------------|------------------|
| 1) Bucket link | 6) Movable hook |
| 2) Bucket link pin | 7) Cylinder |
| 3) Lock plate | 8) Arm |
| 4) Lock pin | 9) Hose |
| 5) Cylinder pin | 10) Arm link pin |

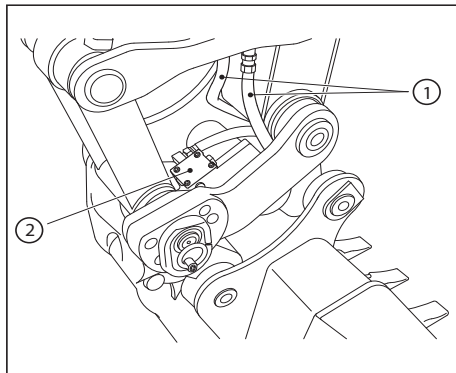

- 1) Hose
- 2) Pilot chec valve

Attachment types

- 1) The attachments, which can be mounted on the machine with quick coupler, are only the same 2-pin type as the bucket. The 1-pin type such as clamshell cannot be mounted in the quick coupler.
- 2) The following 2-pin type of attachments exceptionally cannot be mounted in the quick coupler.
 - (1) Attachments much different from the standard bucket in shape of mounting part
 - (2) Attachments with excessively long or short pin pitch
- 3) Do not use any attachments improper for the machine with the quick coupler.

Allowable size of bucket

Allowable size of bucket to be mounted in the quick coupler
Unit : mm

Mark	Part	ViO50U / ViO57U	
A	Attachment width	140 or more	
B	Distance between pins	Pin diameter 40	191 to 298
		Pin diameter 45	202 to 317
C	Operating radius of bucket	880 or less	
D	Pin diameter	40 to 45	

22 Options

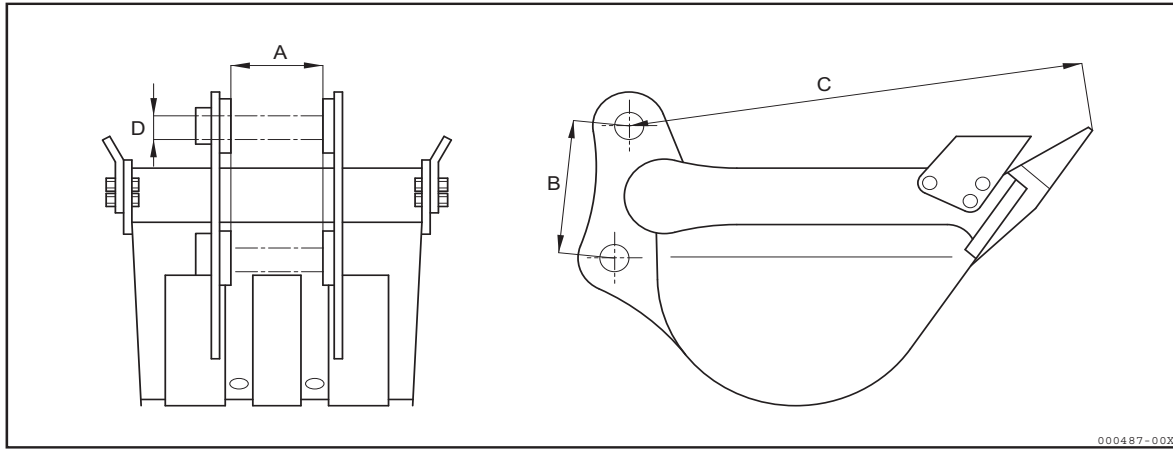

Phenomena that are not breakdowns

While setting the control switch of the quick coupler in the dismounting mode, stop the engine and then restart it to open the hook of the quick coupler.

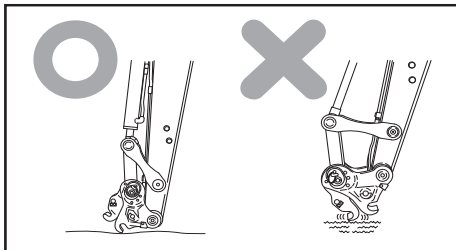

Posture for storing the machine without attachment

Place the quick coupler on the ground as illustrated in the right figure for a long-term storage.

If the quick coupler is placed on the ground when the control switch is in the dismounting mode, the hook will open when the engine is restarted, causing the floor surface scratches or the machine breakdown.

Dismounting attachment

⚠ WARNING

- **Never** dismount the Attachment while it is still elevated, as it will drop to the ground and could cause bodily injury.
- **Never** dismount the Attachment unless it is resting on stable level ground, as it could otherwise fall over.

- 1) Park the machine on stable level ground.

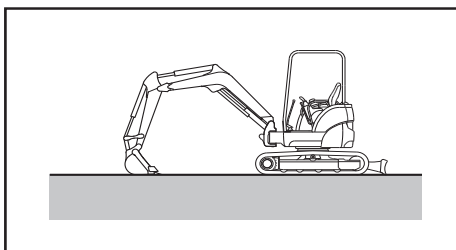

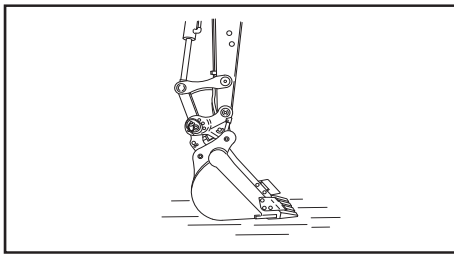

2) Lower the attachment onto the ground.

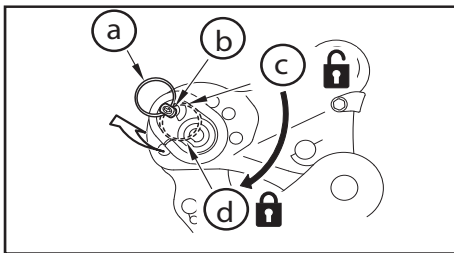

3) Set up the handle of the lock pin.

- a) Handle
- b) Lock pin
- c) Unlock
- d) Lock

4) Turn the arrow on the head of the lock pin from the lock position to the unlock position, and then pull it up.

IMPORTANT

The lock pin cannot be removed from the body.

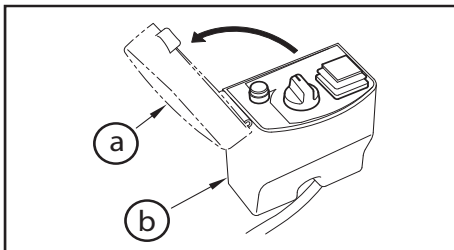

5) Open the switch box cover.

- a) Cover
- b) Switch box

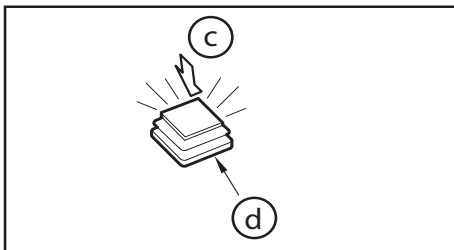

6) Press the power supply switch.

Then, beeps sound and the power supply switch blinks.

- c) Press
- d) Power supply switch

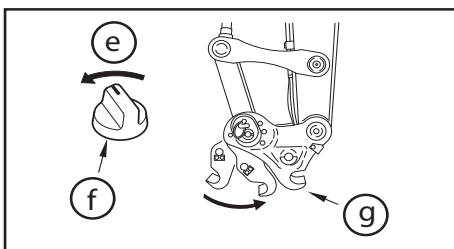

7) Turn the control switch to the dismounting position on the left side, and the attachment is dismounted.

- e) Turn to the left
- f) Control switch
- g) Quick coupler

22 Options

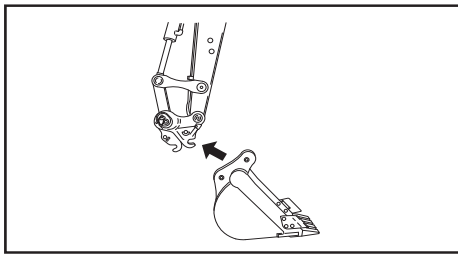

8) Remove the quick coupler from the attachment.

Mounting attachment

⚠ WARNING

- Never place your hands or any other part of your body between the Quick Coupler and the Attachment to prevent bodily injury.
- Never stand near the Attachment unless it is resting on stable level ground to avoid bodily injury.
- Never use a newly mounted Attachment before confirming that it has been properly secured to the Quick Coupler, and that the Lock Pin has been correctly installed, as accidental detachment could otherwise result.
- Always replace the Lock Pin if damaged or lost.
- Failure to do so could result in death or serious injury.

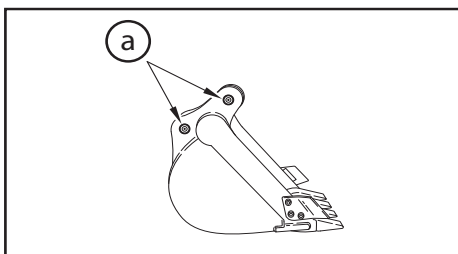

1) Place the attachment on stable level ground. Be sure to install the pins into the attachment.

a) Pin

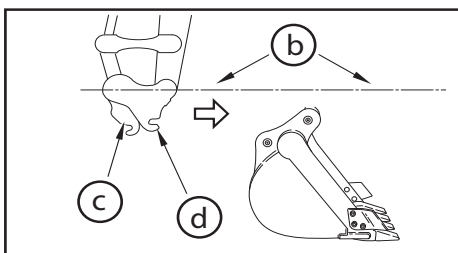

2) Close the movable hook.

3) Put the fixed hook onto the pin of the attachment on the arm side and set the quick hitch level with the ground as illustrated in the right figure.

b) Level with the ground

c) Movable hook

d) Fixed hook

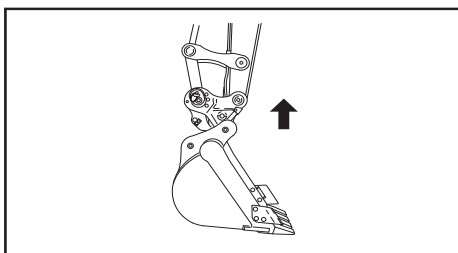

4) Lift the attachment up in that state.

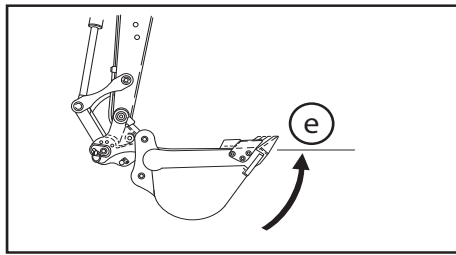

- 5) Curl the attachment so that it is level.
e) Level

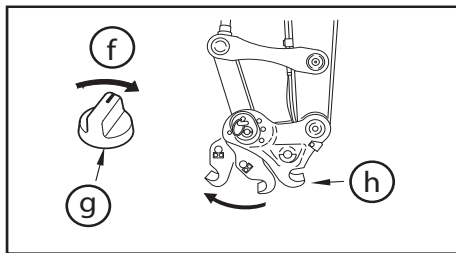

- 6) Turn the control switch to the mounting position on the right side, and the attachment is mounted.
f) Turn to the right
g) Control switch
h) Quick coupler

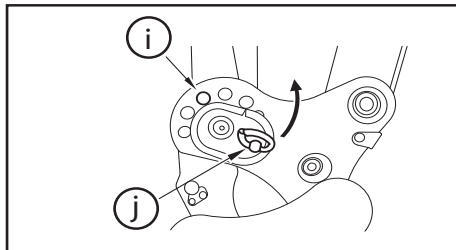

- 7) Only one of the bores allows the whole lock pin. Install the lock pin to that bore.
i) Bores
j) Lock pin

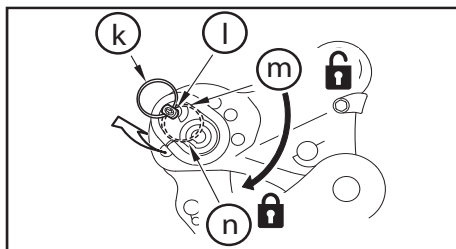

- 8) Turn the arrow on the lock pin to the lock side.
9) Put the handle of the lock pin down to the arrowed side.
k) Handle
l) Lock pin
m) Unlock
n) Lock

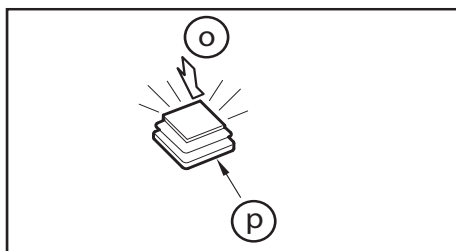

- 10) Make sure the attachment is securely mounted in the quick coupler before pressing the power supply switch on. The beeps stop sounding and the red lamp goes off.
o) Press
p) Power supply switch
11) Close the switch box cover.

Maintenance

- 1) Checking specifications
- Check there are no cracks and plays.
 - Check the bolts and nuts for looseness.
 - Check the hydraulic piping for oil leak.

22 Options

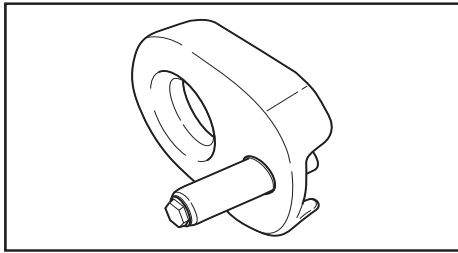

2) Installation instruction of the Lock Pin

- (1) Remove the damaged lock pin if any, and clean the bore of the lock plate.

Note:

Replace the lock plate with a new one if it is damaged.

- (2) Put a new lock pin into the bore of the lock plate.
- (3) Install the washer and nut onto the lock pin from the back side of the lock plate.

Note:

Apply a lock agent ThreeBond 1324 on the thread.

- (4) Tighten the nut (M6, Hex 10 mm) to 7.5 to 8.5 ft•lb.
- (5) Confirm if the new lock pin can smoothly move to the lock and unlock positions.

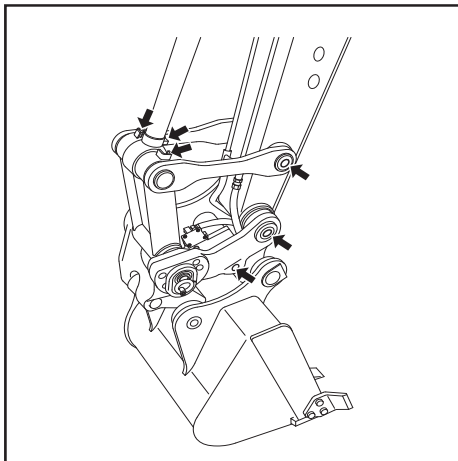
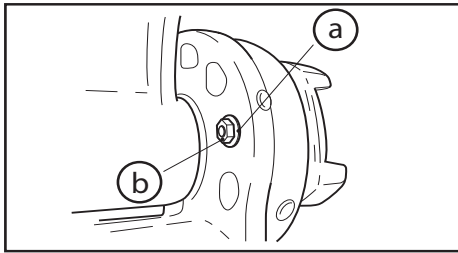

3) Greasing

IMPORTANT

Grease the fittings thoroughly after washing the machine or after operation in rain, on soft ground, or in muddy water.

- (1) Put the bucket and the blade on the ground and stop the engine.
- (2) Clean the grease nipples indicated with the arrows in the right figures and grease them using a grease gun.
- (3) After greasing, wipe off the excessive grease with waste cloth or the like.

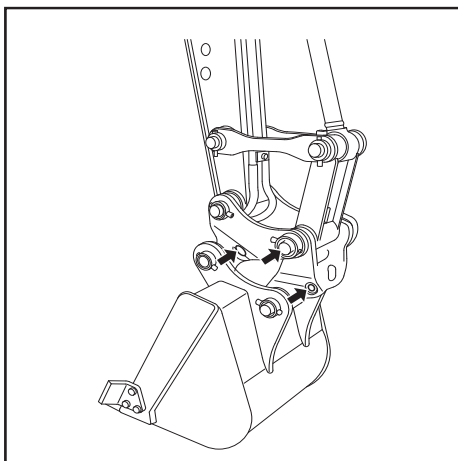

4) Nonperiodic inspection

- The pins in the attachment are free from rotation and cannot be worn.
Apply antirust solvent or grease to them to prevent rust.

**(12) Quick coupling:****Coupling**

The coupling sleeve is connected on the connector using the hand. A slight click tells you the coupling is connected. The ball inside the sleeve is engaged in the groove on the connector, the coupling is completed. By rotating the socket on the sleeve, the ball is pressed into the groove, the coupling is secured.

Uncoupling

To uncouple, pull and rotate the socket until the edges release the holding ball, then slide the socket backwards.

(13) Refuelling electrical pump:

To use the refuelling electrical pump, refer to chapter 11.7 'Using the refuelling electrical pump' in this manual.



22 Options



HYDRAULIC AND WIRING DIAGRAMS





23 Hydraulic and wiring diagrams

23 Hydraulic and wiring diagrams

23.1 Hydraulic diagrams
VIO17 (EP)

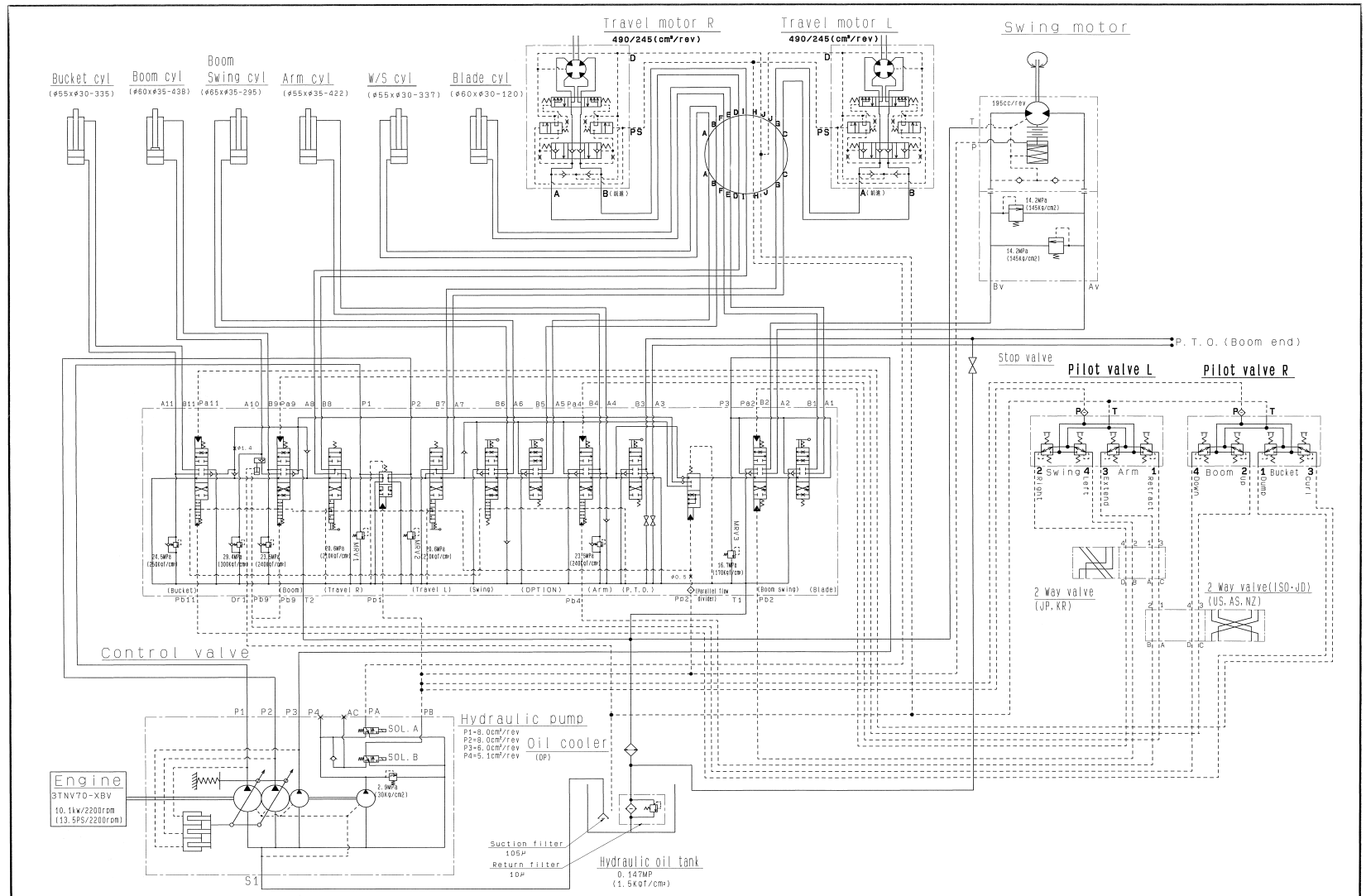



VI020-3

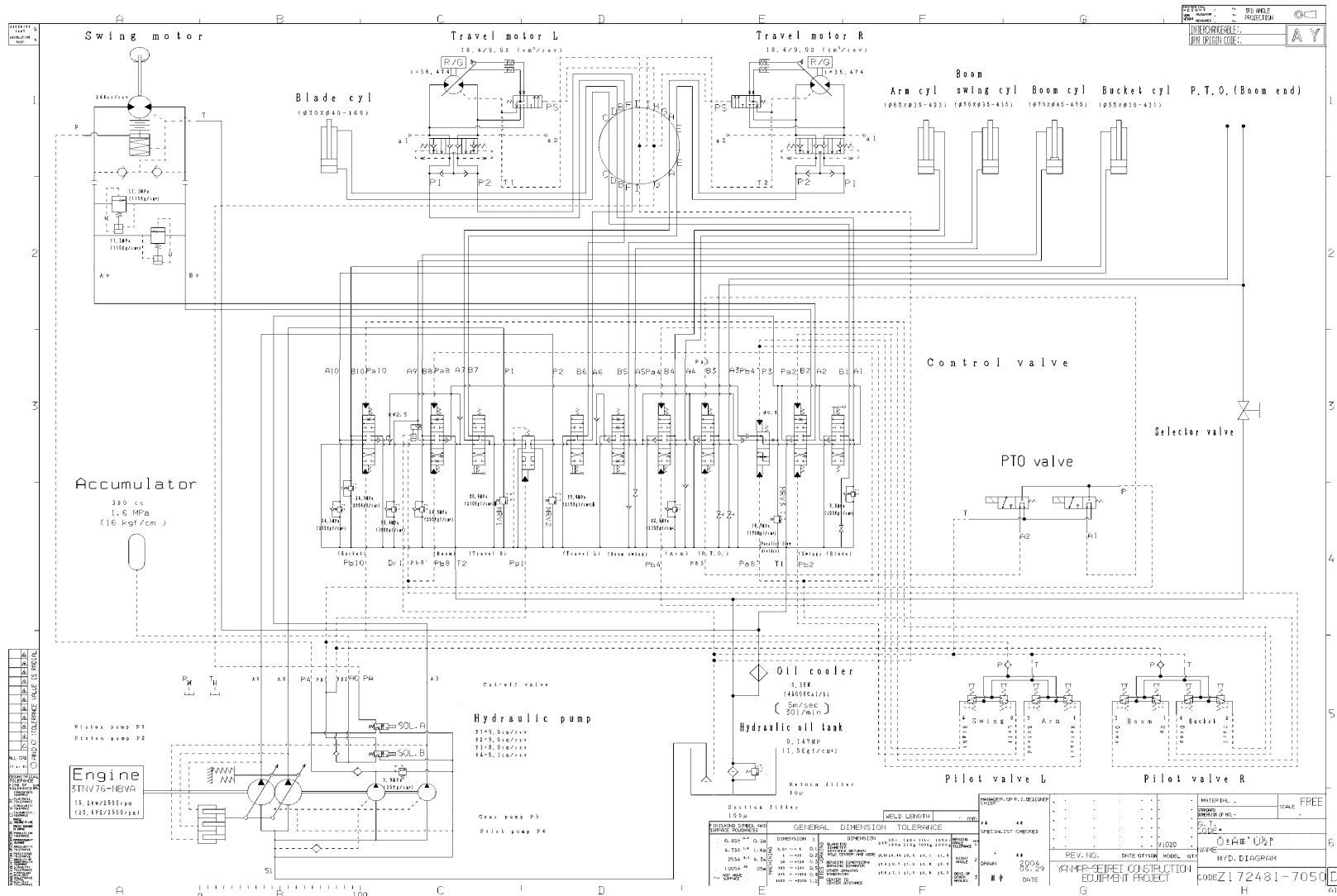



23 Hydraulic and wiring diagrams

ViO25-3

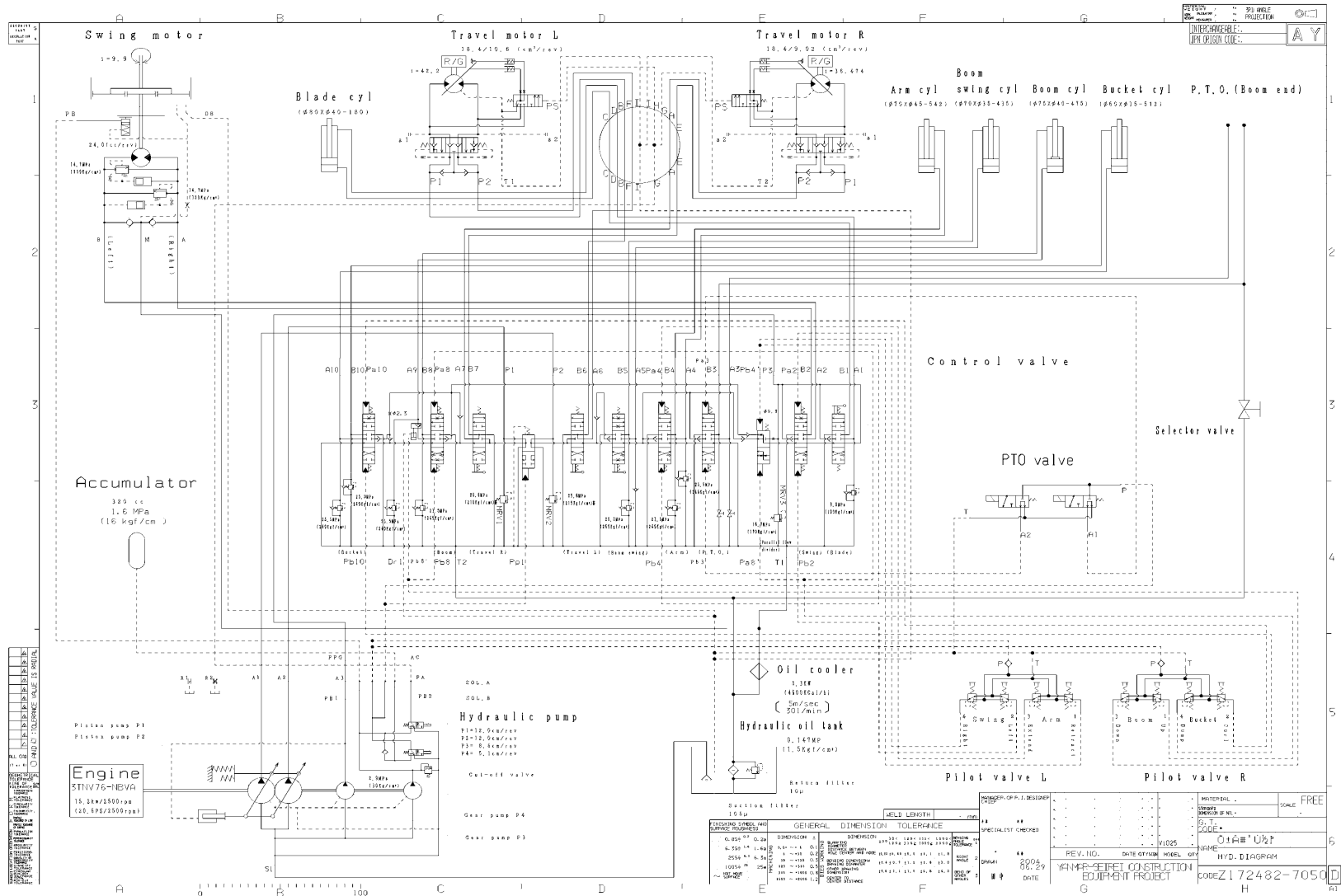



23 Hydraulic and wiring diagrams

VI030-3

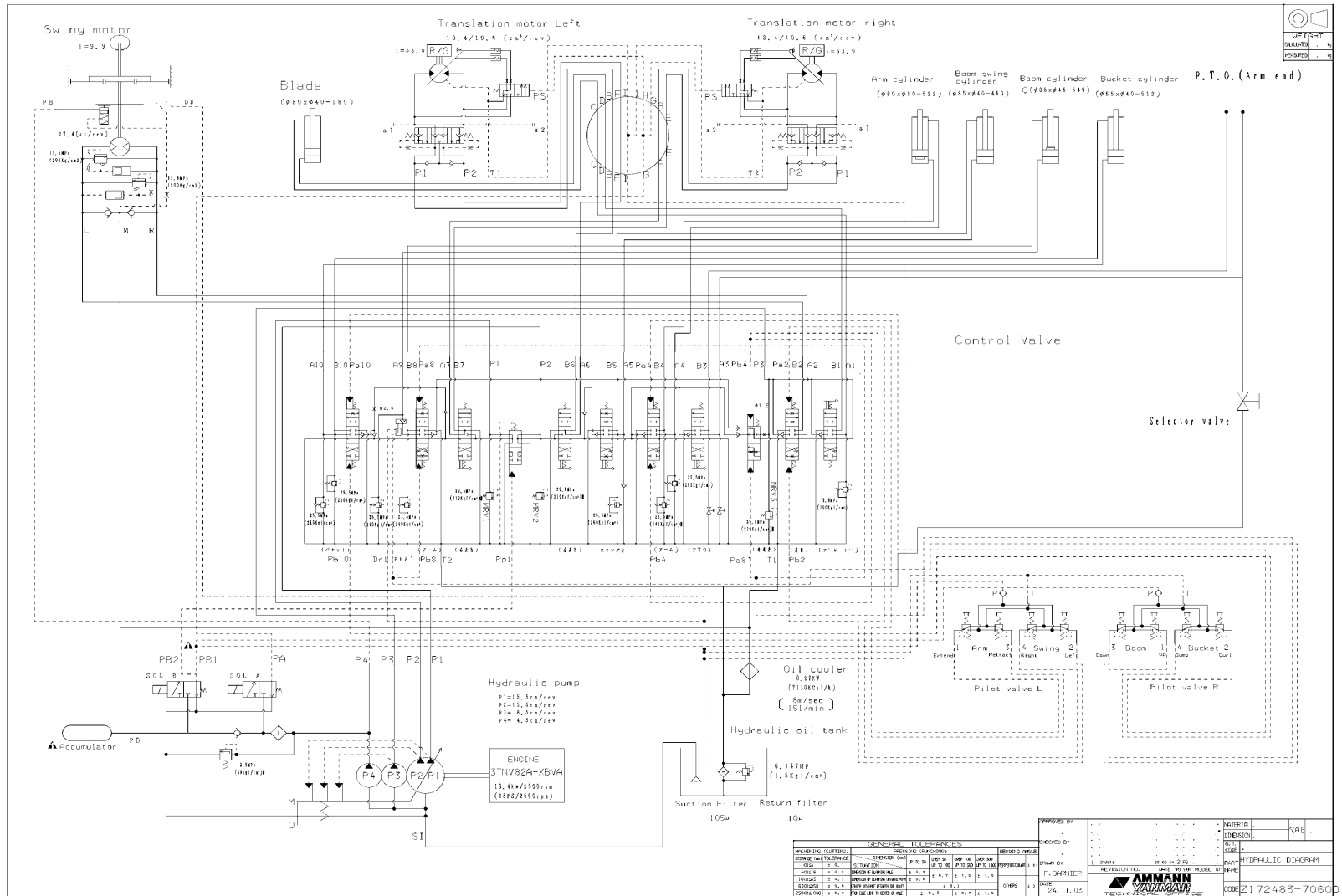



23 Hydraulic and wiring diagrams

ViO35-3

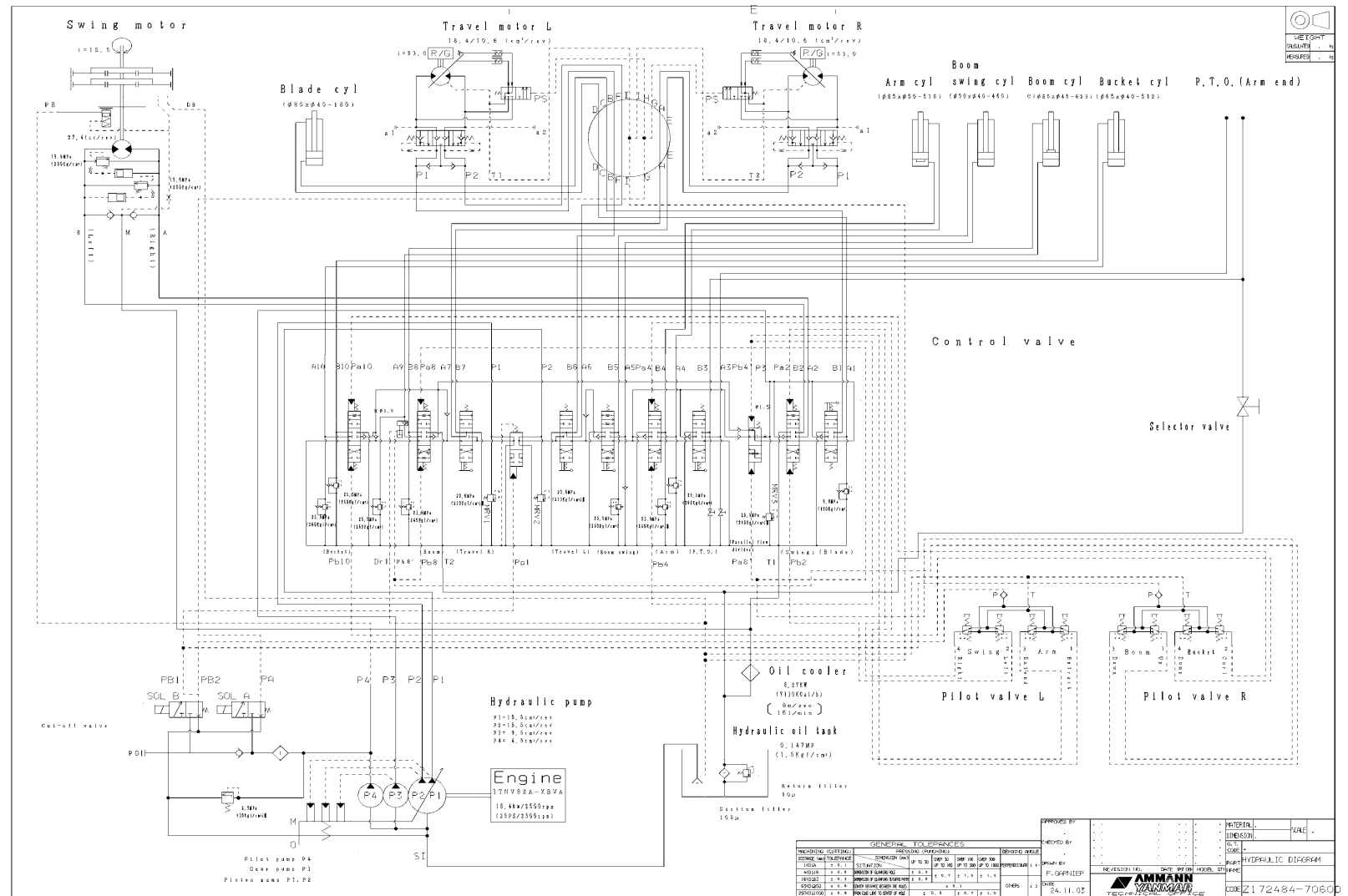



**23.2 Wiring diagrams
VI017 (EP)**

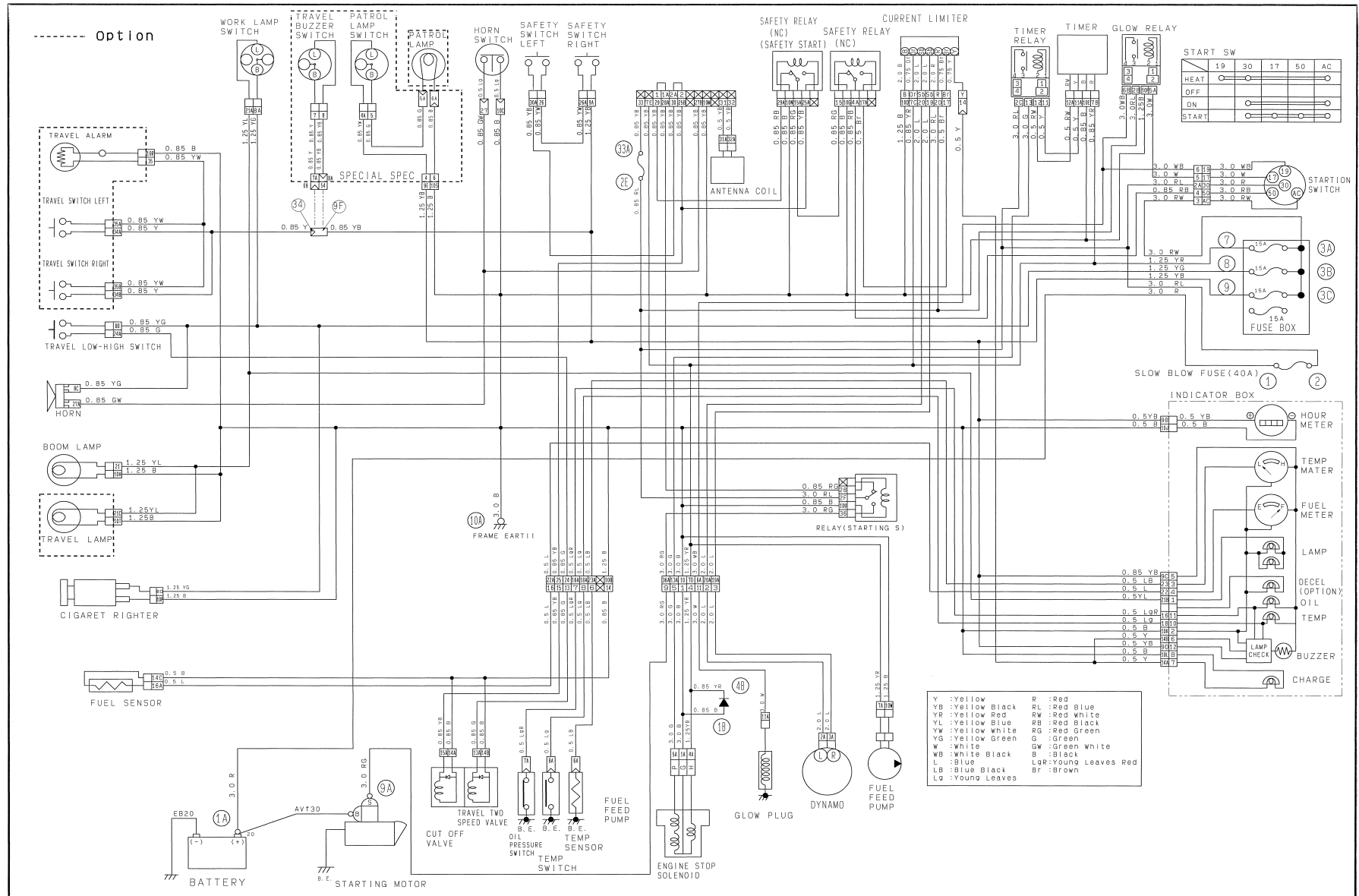



23 Hydraulic and wiring diagrams

ViO20-3 and ViO25-3

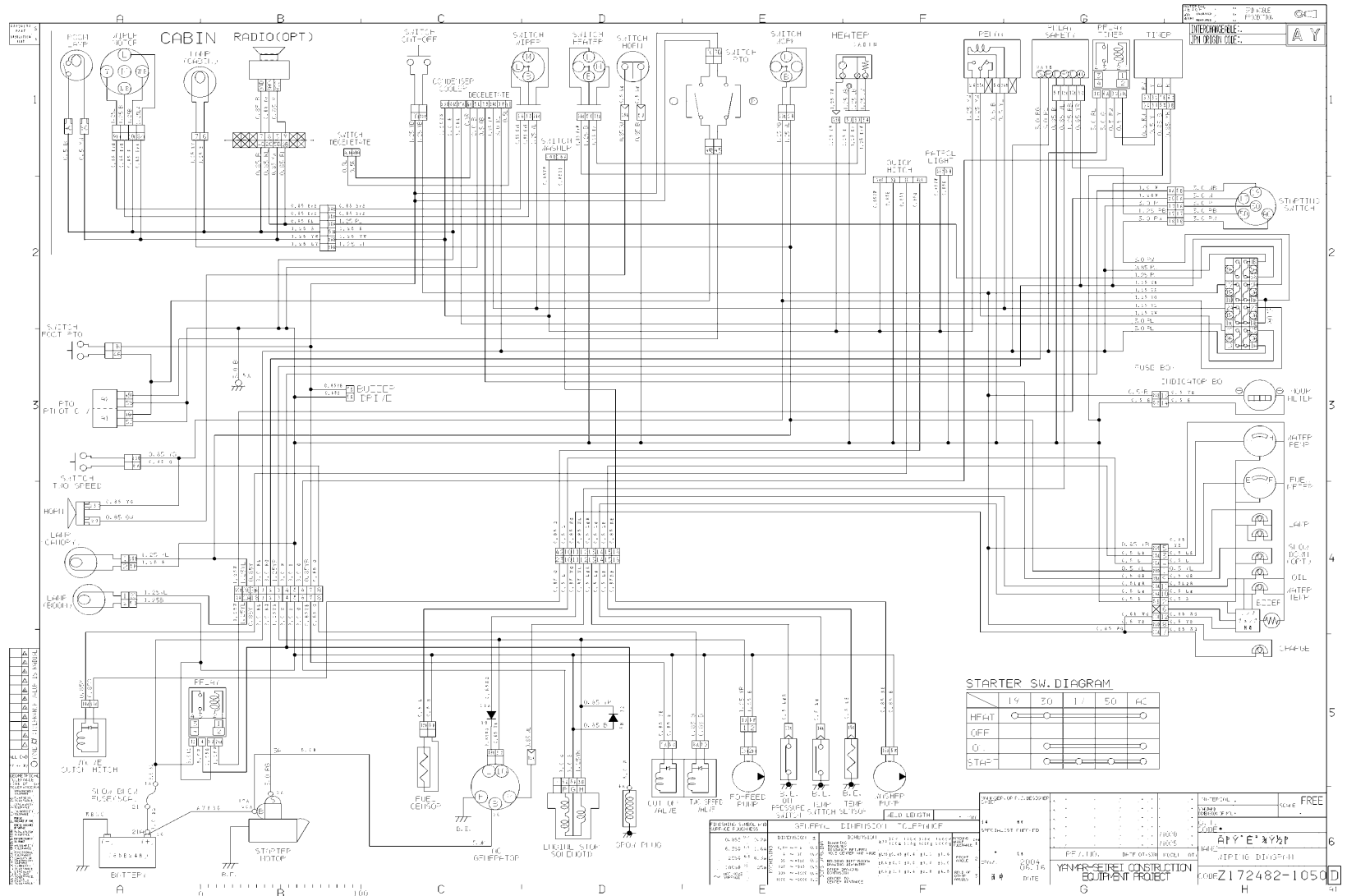



ViO57U

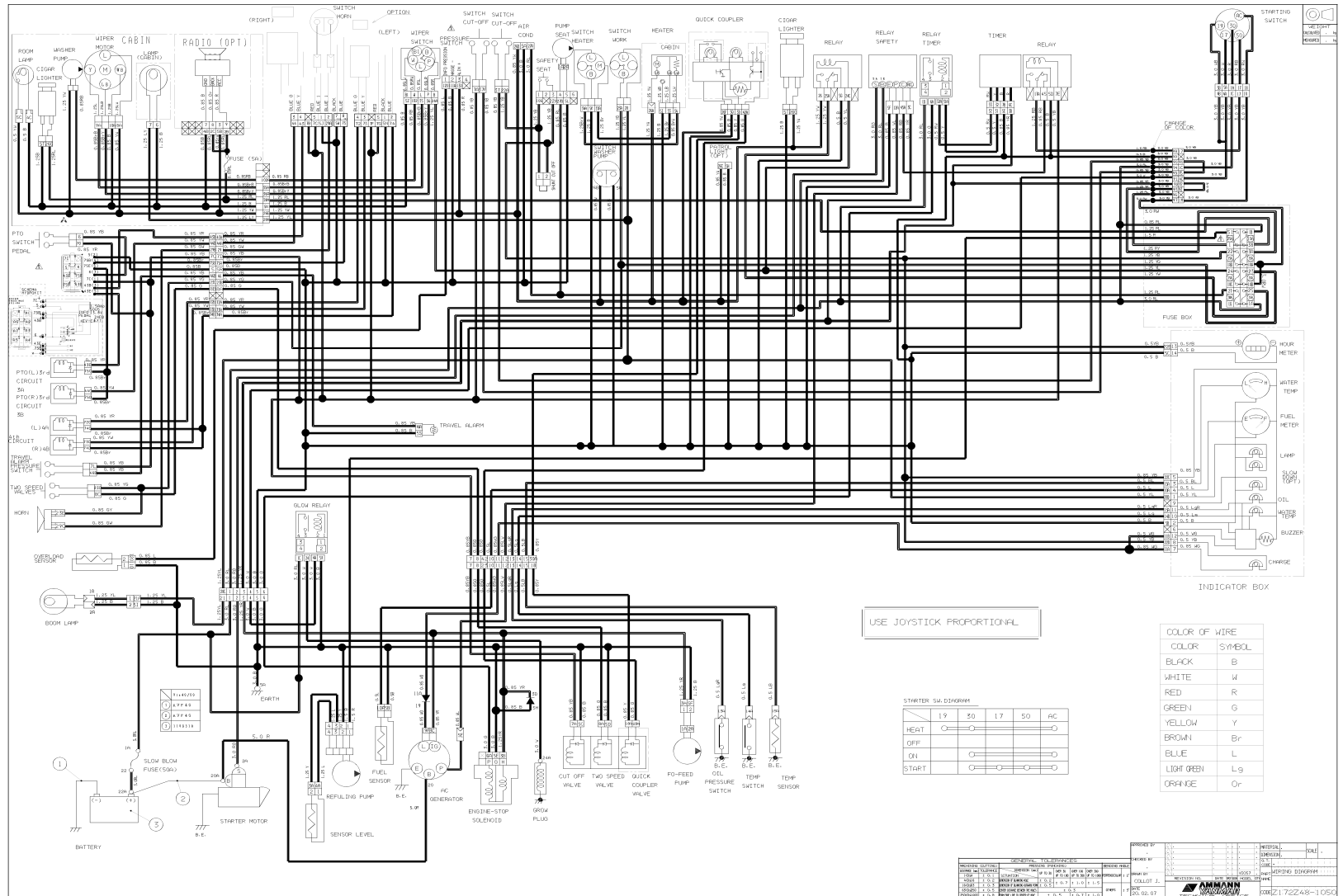



NOTES





Inspection after 1 year or 1000 hours (first term reached)

Customer's copy

INSPECTION AFTER 1 YEAR OR 1000 HOURS (first term reached)		
Machine:	Serial number:	
Customer:	Delivery date:	
Inspection's date:	Hours:	
The inspection was carried out according to the Ammann Yanmar schedule		
Note:		
Dealer's signature and stamp:		Customer's signature:



This copy to be retained by the dealer



INSPECTION AFTER 1 YEAR OR 1000 HOURS (first term reached)		
Machine:	Serial number:	
Customer:	Delivery date:	
Inspection's date:	Hours:	
The inspection was carried out according to the Ammann Yanmar schedule		
Note:		
Dealer's signature and stamp:		Customer's signature:

*The inspection date must be notified to AMMANN YANMAR







YANMAR MINI-EXCAVATORS
ViO17(EP) - ViO20-3 - ViO25-3
ViO30/35-3 - ViO50U - ViO57U

**YANMAR CONSTRUCTION
EQUIPMENT EUROPE S.A.S.
25 rue de la Tambourine
52100 Saint-Dizier / France**